

АЭРОДРОМНЫЙ ТЯГАЧ БЕЛАЗ 74271



ИНСТРУКЦИЯ ПО СБОРКЕ



EN Pay attention
 PL Uwaga
 FR Préster attention
 ES Prestar atención
 DE Achtung
 RU Уделить внимание
 IT Prestare attenzione
 CZ Pozor
 CN 请注意



EN Remove the burrs with sandpaper
 PL Usunąć zadziory papierem ściętym
 FR Retirer les rebabes avec du papier à polir
 ES Quitar las rebabas con el papel esmeril
 DE Grate mit Schleifpapier entfernen
 RU Удалить заусенцы наждачной бумагой
 IT Sbravare con carta vetrata
 CZ Vyhladte smirkových papirem
 CN 用砂纸去除毛刺。

EN The manufacturer reserves the right to make changes in the design of the product, not worsening its technical characteristics. Information about the changes made may not be present in the manual.

PL Producent zastrzega sobie prawo do zmiany konstrukcji wyrobu bez pogorszenia jego właściwości technicznych. Niniejsza instrukcja może nie zawierać informacji o zmianach.

FR Le producteur se réserve le droit d'apporter des modifications dans la construction du produit à condition qu'elles ne portent atteinte à ses caractéristiques techniques. Les renseignements sur les modifications apportées peuvent ne pas être dans le présent manuel.

ES El fabricante se reserva el derecho de introducir modificaciones en la construcción del producto, que no empeoren sus características técnicas. Datos sobre modificaciones introducidas pueden no aparecer en esta instrucción.

DE Der Hersteller behält sich das Recht auf Designänderungen, die die technischen Merkmale und Funktionen nicht negativ beeinflussen, vor.

RU Производитель оставляет за собой право вносить изменения в конструкцию изделия, не ухудшающие его технические характеристики. Сведения о внесенных изменениях могут отсутствовать в настоящей инструкции.

IT Il produttore si riserva il diritto di apportare modifiche al design del prodotto, non peggiorando le sue caratteristiche tecniche. Informazioni sulle modifiche apportate potrebbero non essere presenti in questo manuale.

CZ Výrobce si vyhlašuje právo na jakékoliv změny v designu produktu, které nebudou mít za následek zhoršení technických vlastností. Informace o změnách nemusí být v návodu uvedeny.

EN 製造商保留對產品設計更改的權利，一切更改均不會降低產品的技術性能。改動詳情未出現在手冊中。敬請察照。

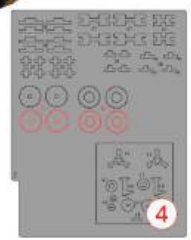
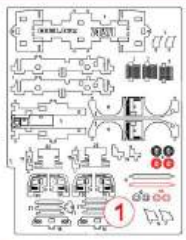
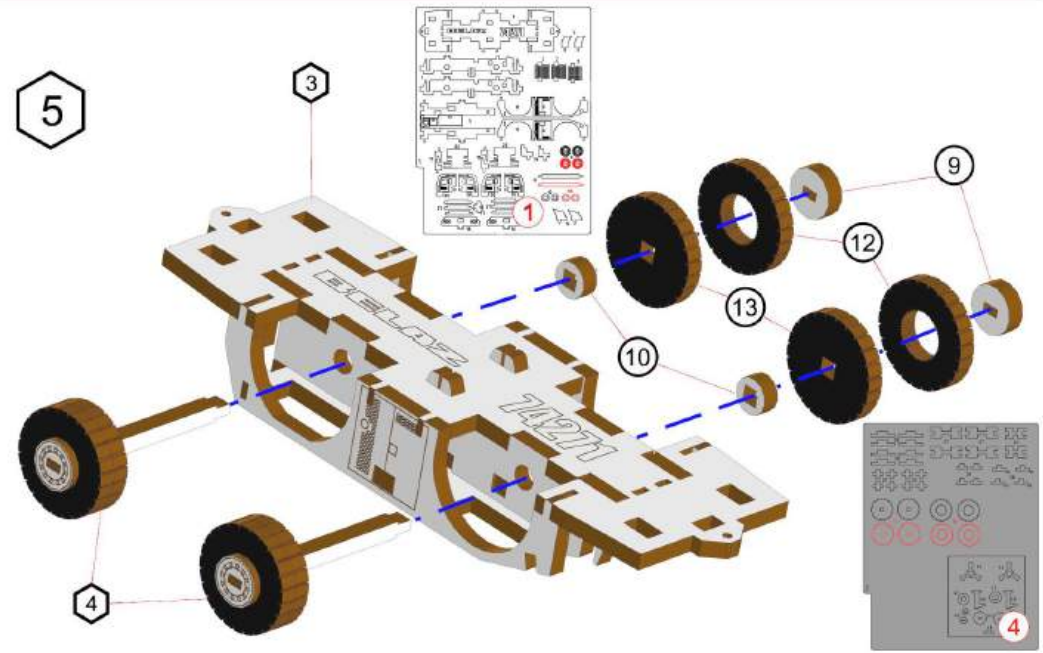
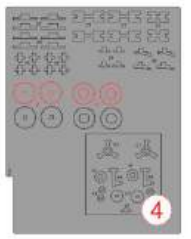
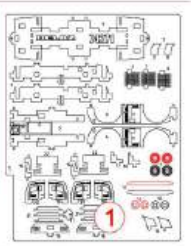
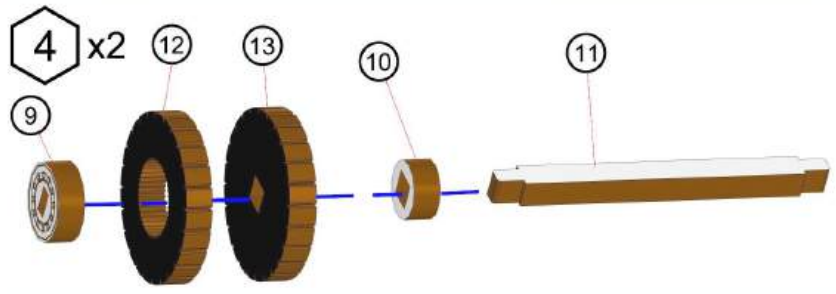
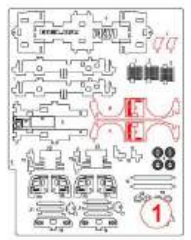
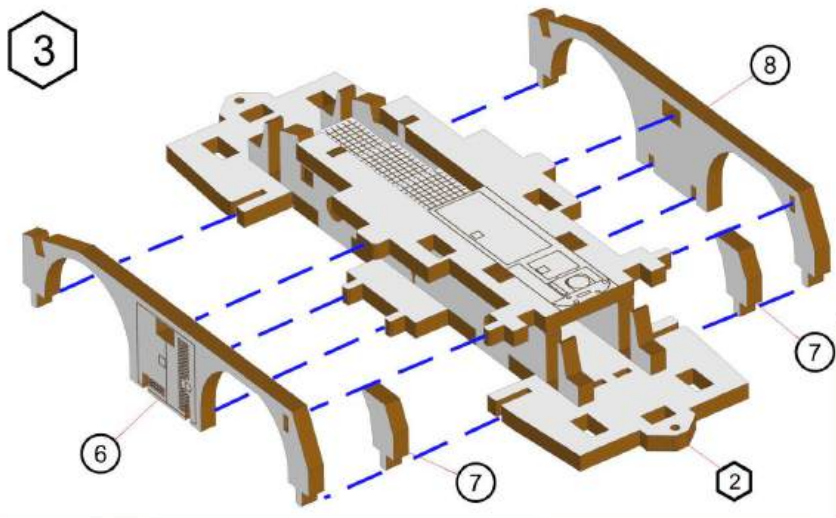

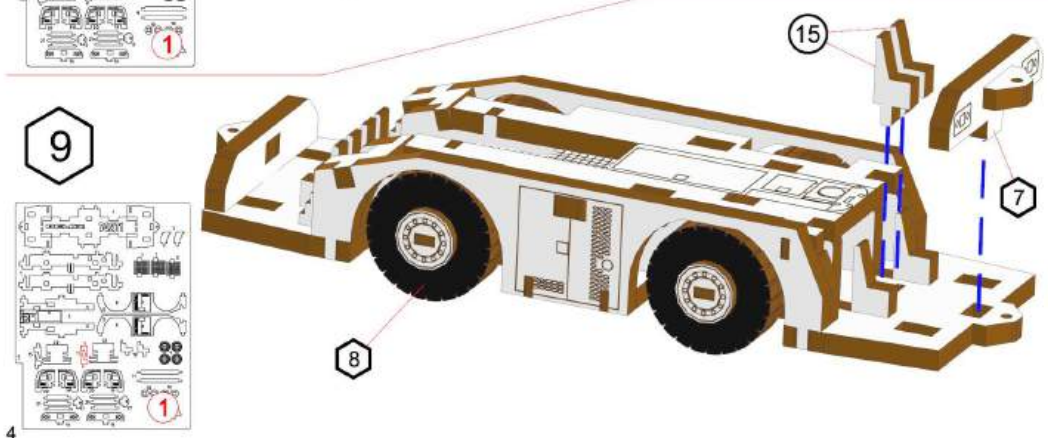
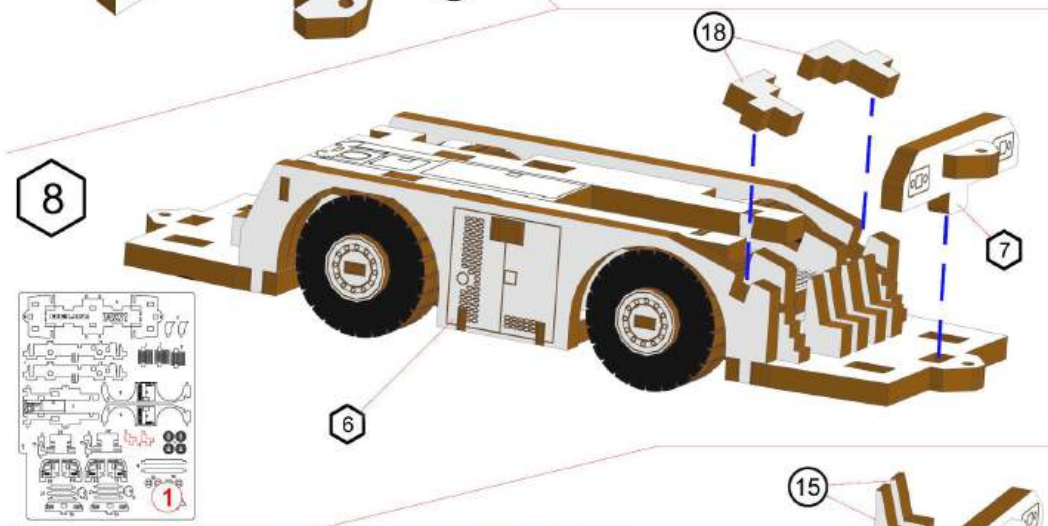
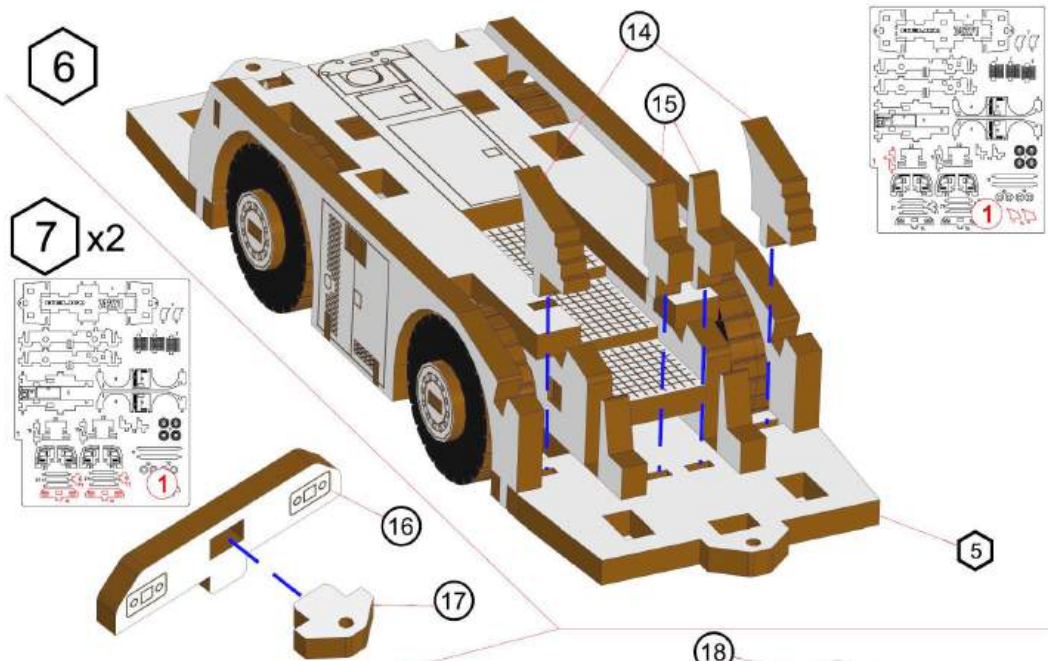

10 x2

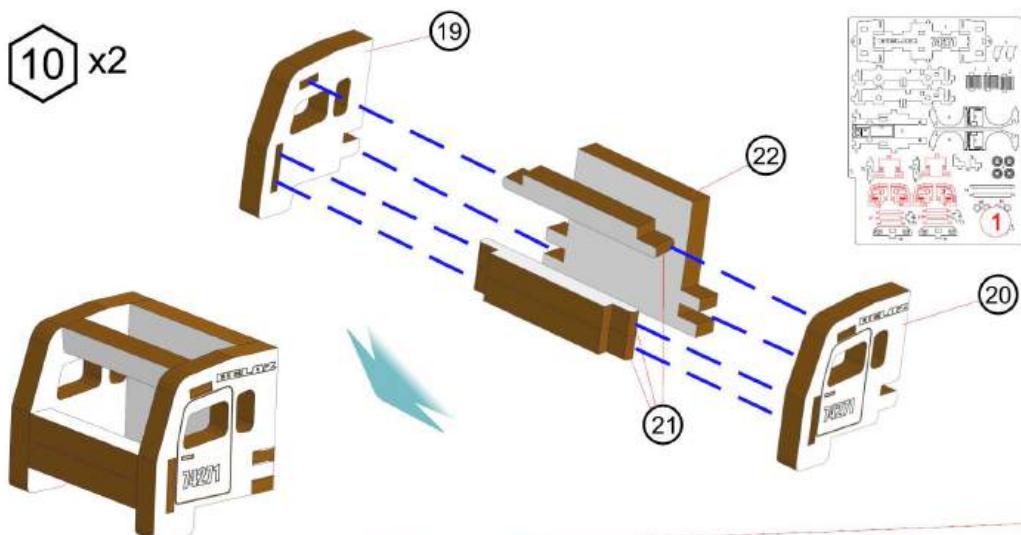

11

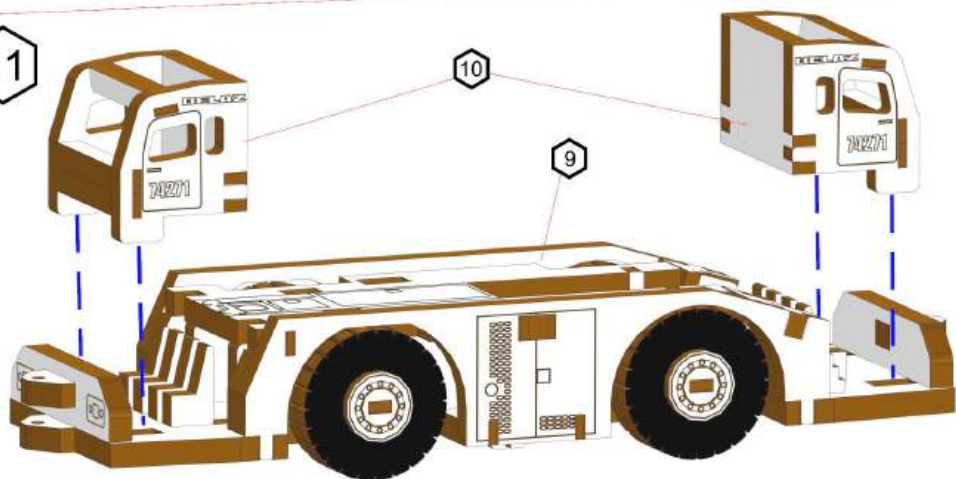

12 x2

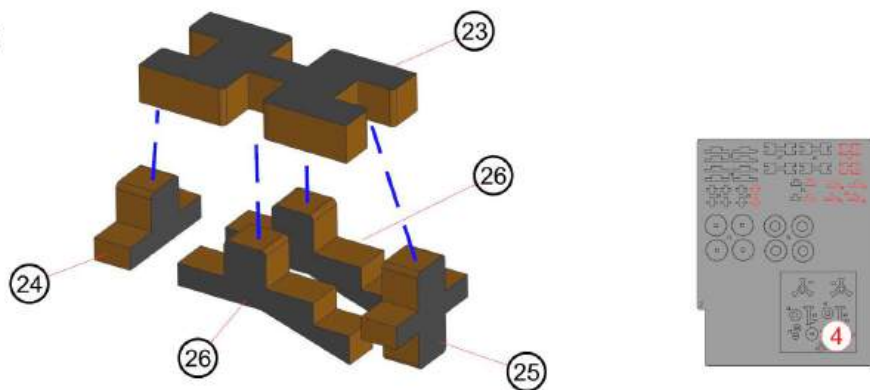

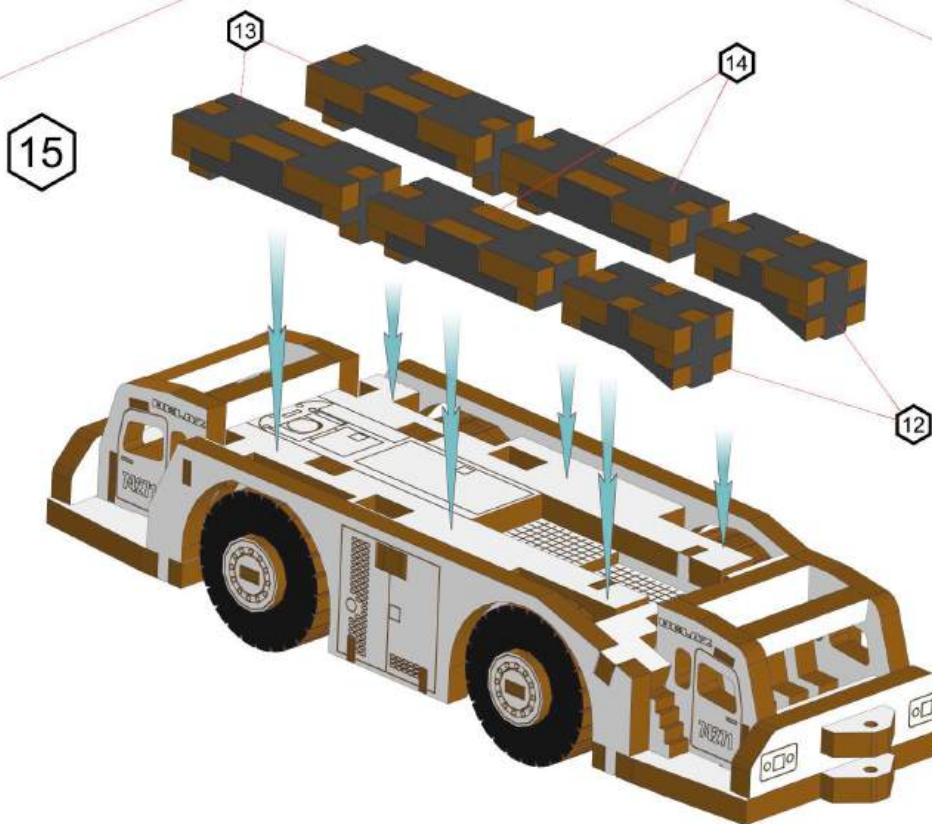
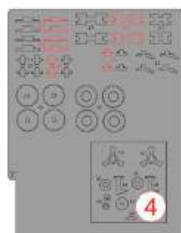
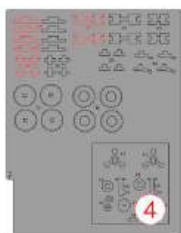
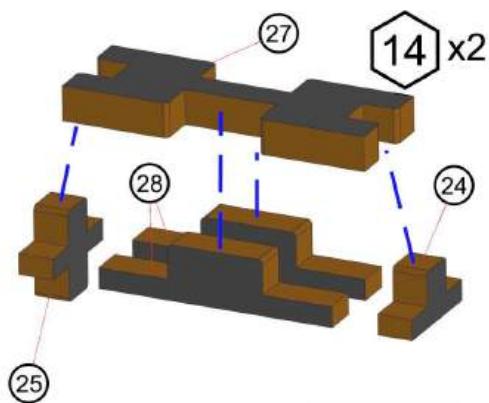
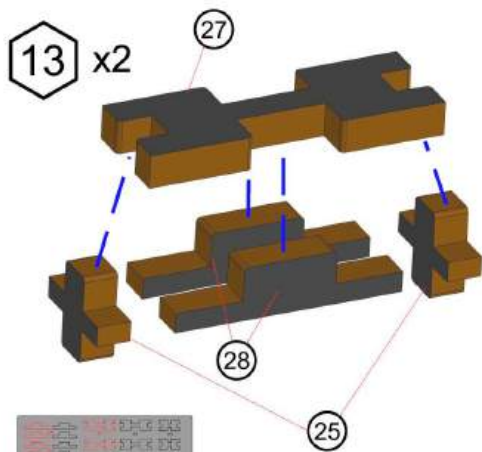

16

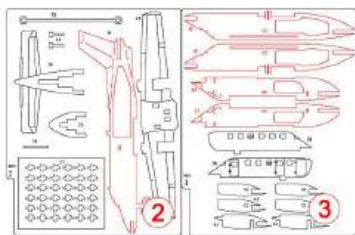
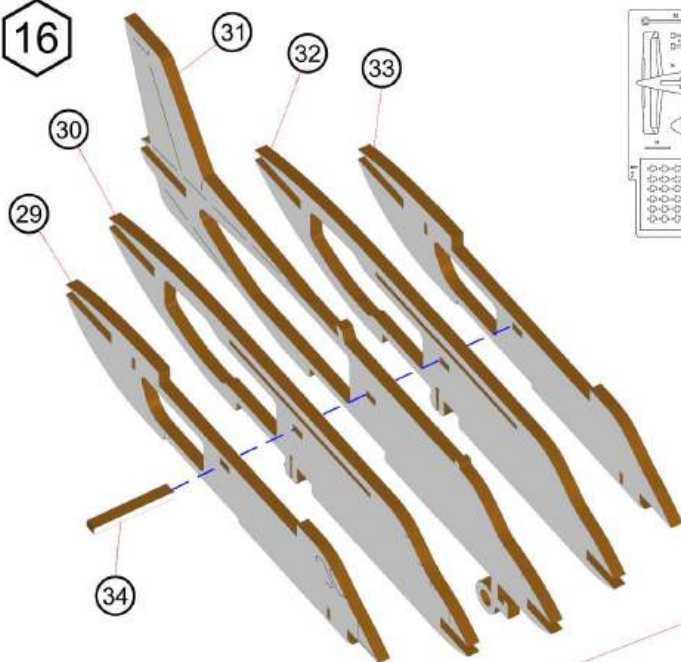

17

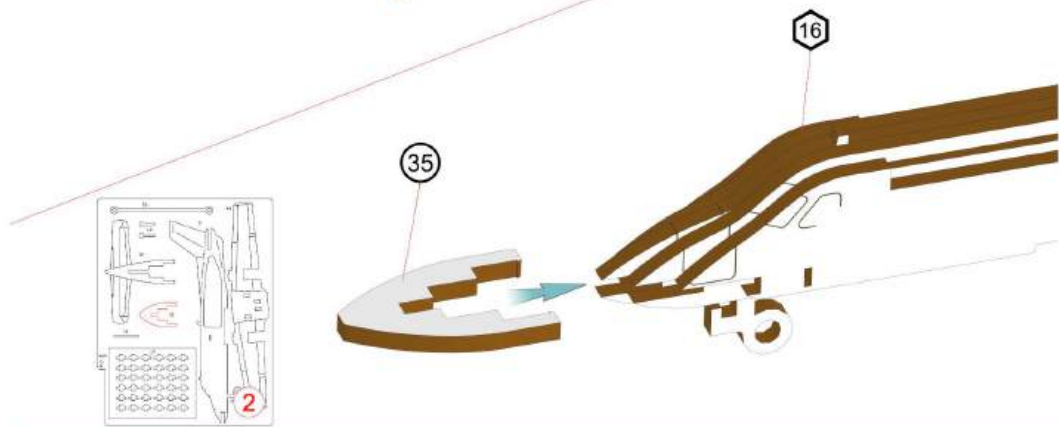

18

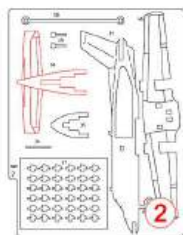
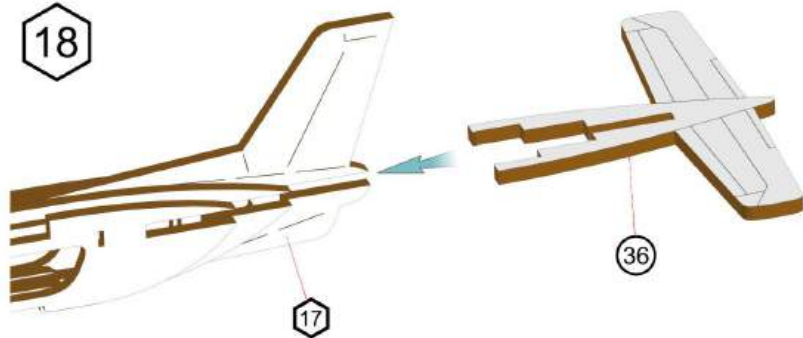

19

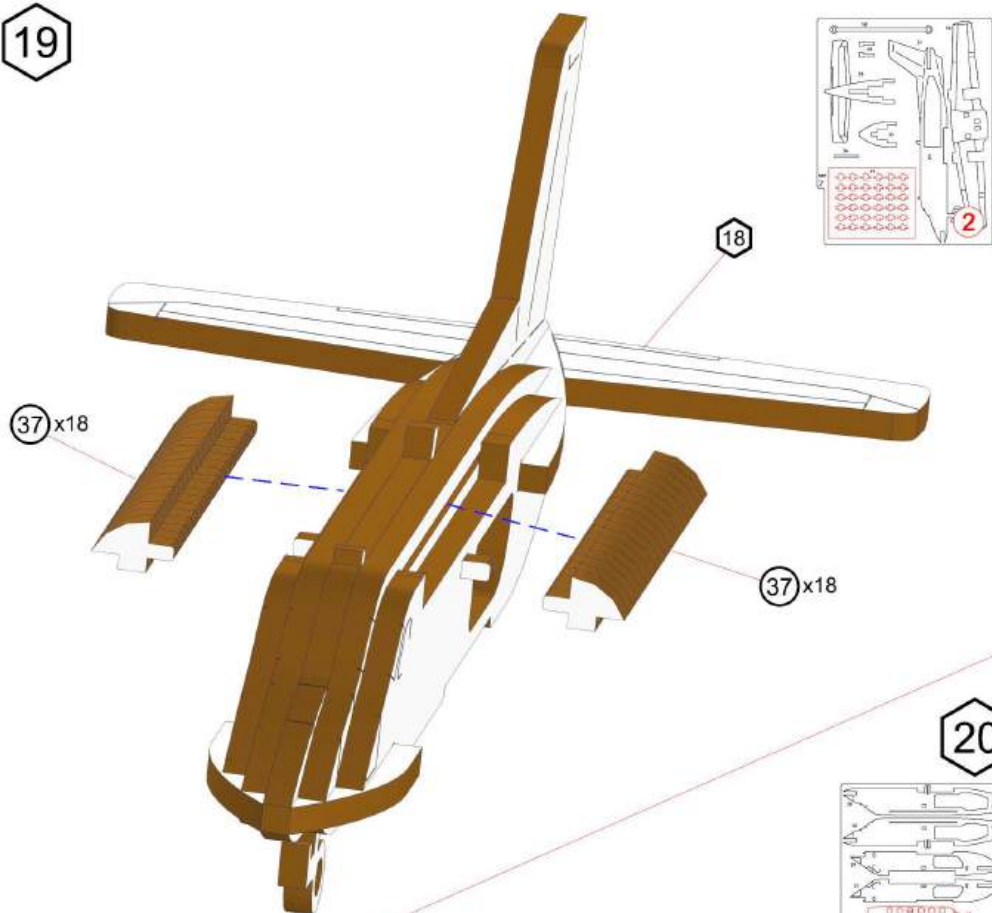

20

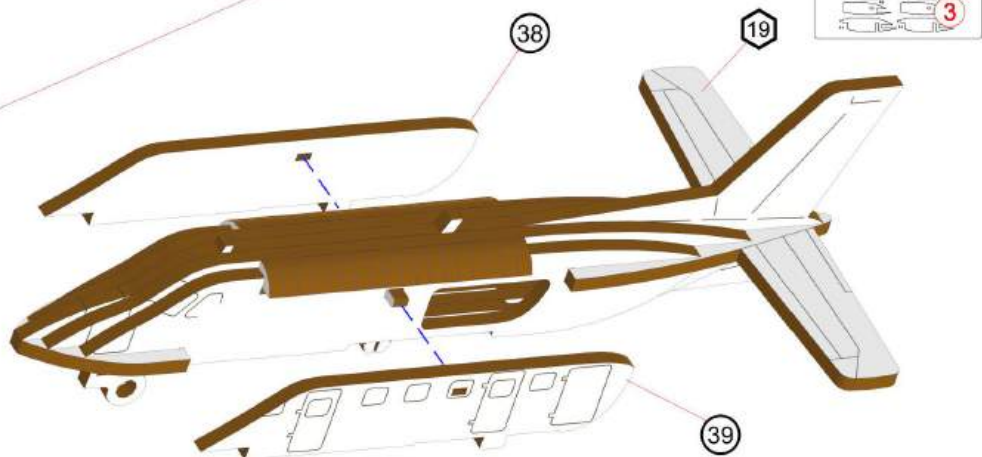

21 x2

22 x2

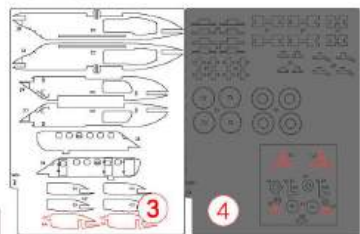
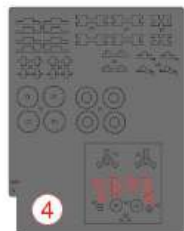
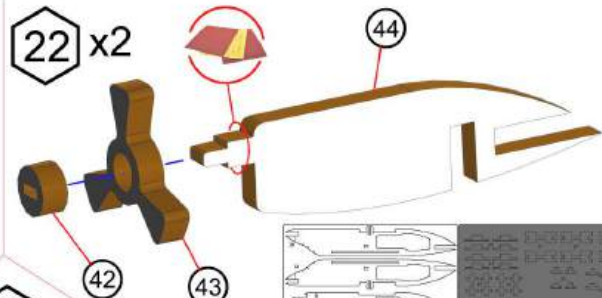
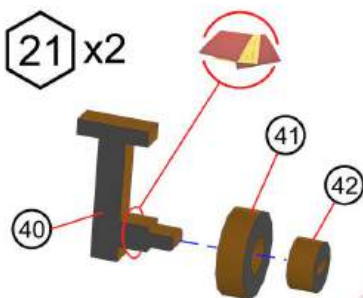

23

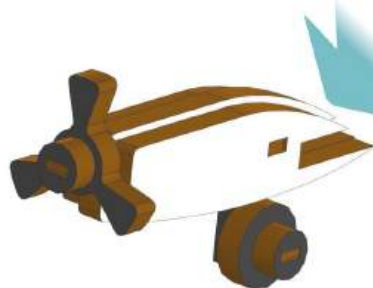
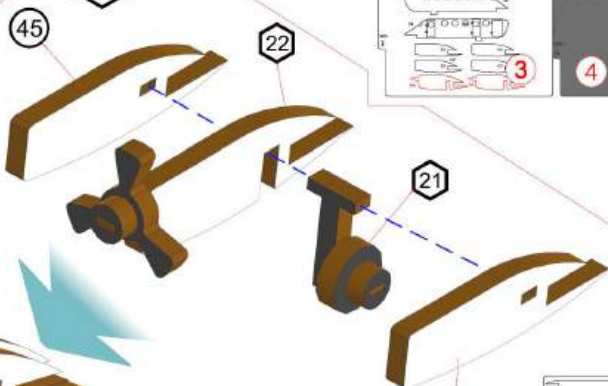

24

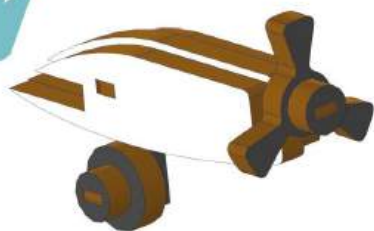
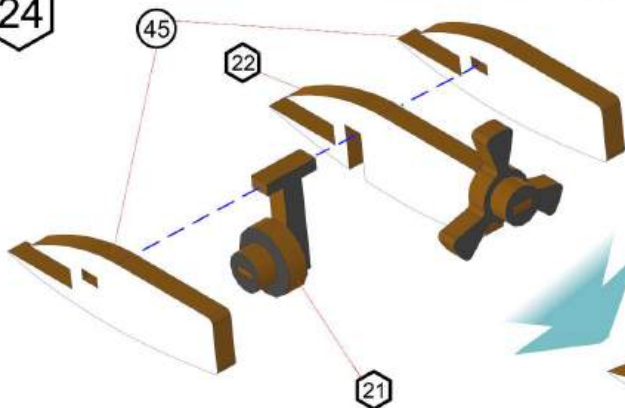

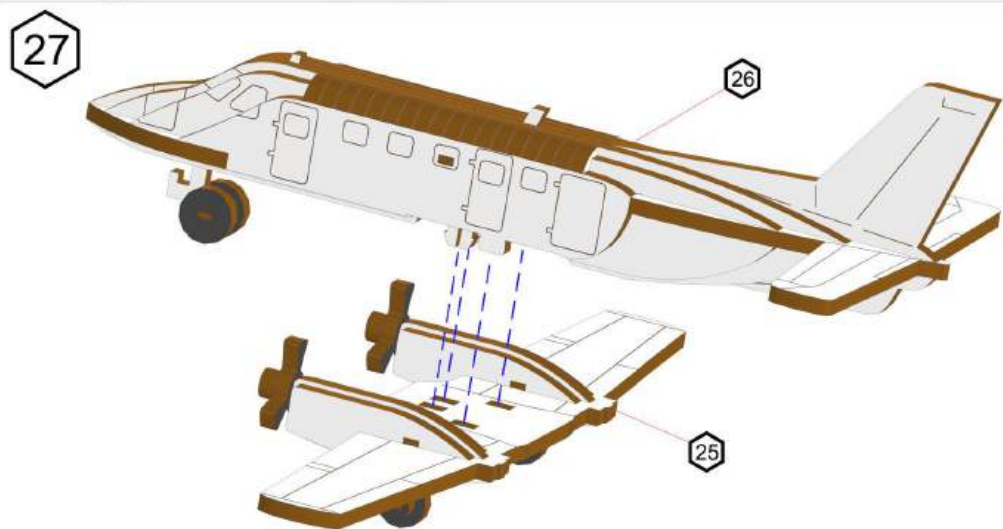
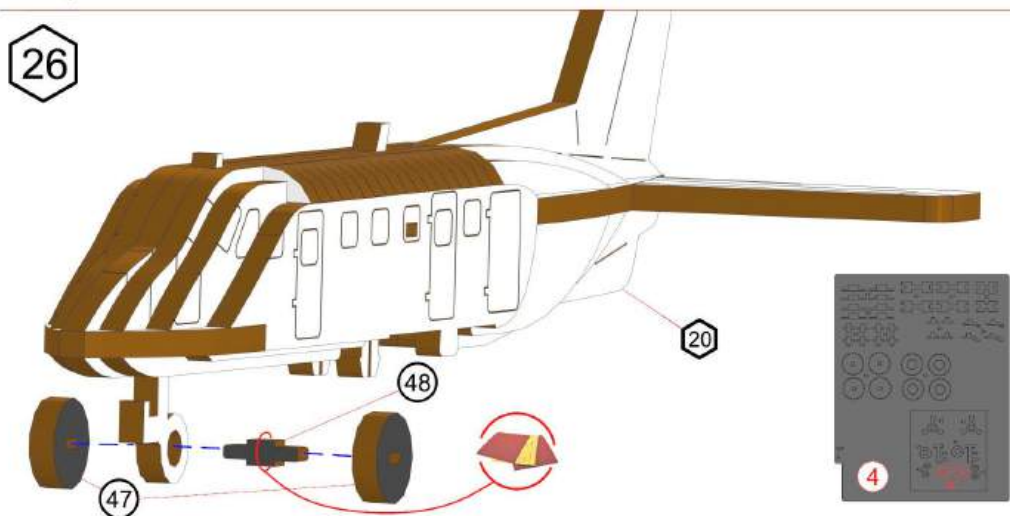
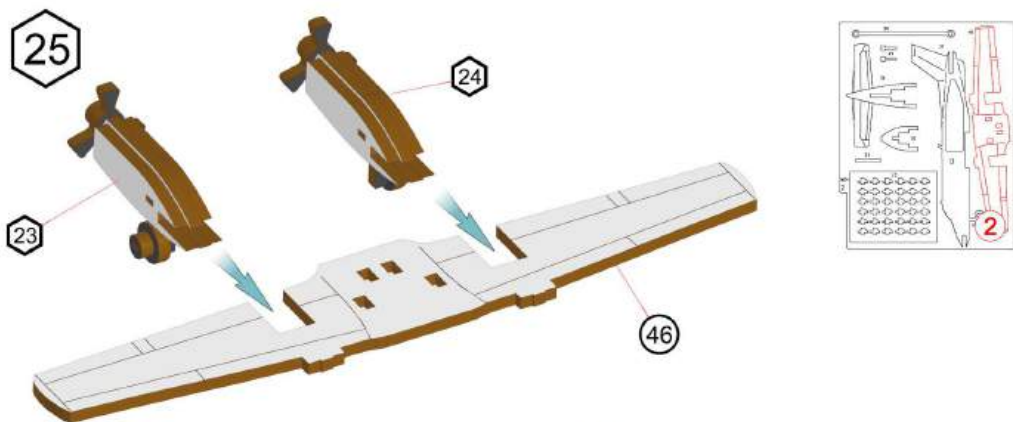

28

15

50

27

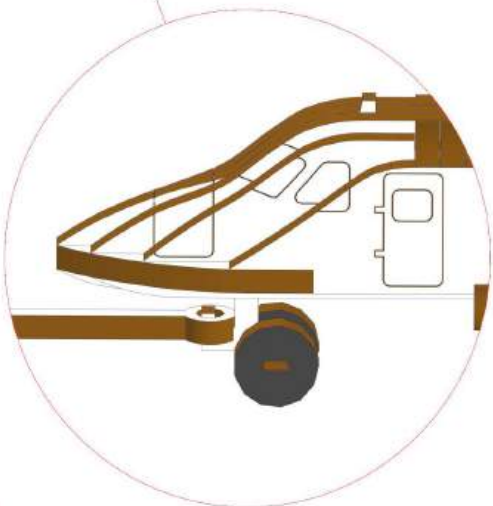
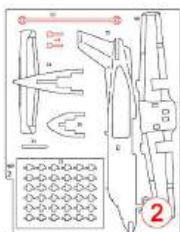
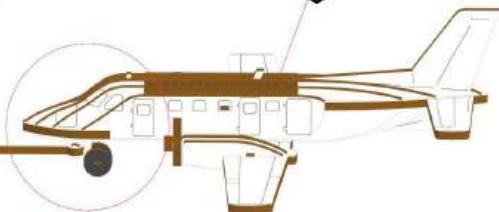
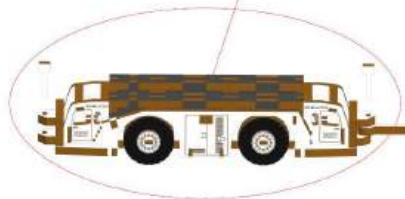

49

