

ATTENTION! ОБРАТИТЕ ВНИМАНИЕ!

EN: Pages 2-33 – these instructions apply to the «Kitten» construction kit manufactured **on or after 23 February 2026** (check the back of the packaging).

RU: Страницы 2-33 – инструкция для набора конструктора «Котёнок» с датой изготовления с **23.02.2026 и позже** (смотреть на обратной стороне упаковки).

EN: Pages 34-65 – these instructions apply to the «Kitten» construction kit manufactured **up to 23 February 2026** (check the back of the packaging).

RU: Страницы 34-65 – инструкция для набора конструктора «Котёнок» с датой изготовления **до 23.02.2026** (смотреть на обратной стороне упаковки).

ASSEMBLY INSTRUCTION FOR MODEL



KITTEN



- EN** The ledge is for the squeezing the small details out of the board
PL Występ w linijce przeznaczony jest do wyciskania małych detali z arkusza sklejki
FR La proéminence est conçue pour aider à presser et enlever les petits détails de la feuille
ES La repisa es para apretar los pequeños detalles fuera del tablero
DE Der Vorsprung dient dazu, kleine Teile aus den Platten zu drücken
RU Выступ предназначен для выдавливания из листа мелких деталей
IT Le proiezioni riportate sui fogli di istruzioni sono utili anche nella fase di smontaggio per estrarre i pezzi
CN 輔助測量尺可幫助取出或緊壓細小零件時使用
CZ Použijte k vytažení malých částí z desky

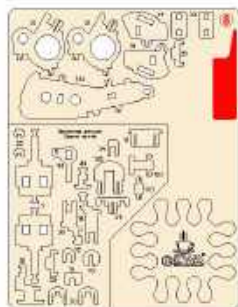

- EN** Wax it with a candle
PL Posmaruj za pomocą świecy parafinowej
FR Graisser avec une bougie de paraffine
ES Engrasar con ayuda de una vela de parafina
DE Mit einer Kerze wachsen
RU Смазать парафиновой свечой
IT Lubrificare con candela di paraffina
CN 用干蜡烛上蜡润滑
CZ Navoskujte svíčkou



- EN** Pay attention
PL Uważnie
FR Faire attention
ES Prestar atención
DE Achtung
RU Уделить внимание
IT Prestare attenzione
CN 请注意
CZ Pozor



- EN** Details should rotate freely
PL Swobodne obracanie
FR Libre rotation
ES Rotación libre
DE Auf freie Rotation achten
RU Свободное вращение
IT Rotazione libera
CN 讓輪地旋轉
CZ Části by se měly volně otáčet

- EN** The manufacturer reserves the right to make changes in the design of the product, not worsening its technical characteristics. Information about the changes made may not be present in this manual.
PL Producent zastrzega sobie prawo do zmiany konstrukcji wyrobu bez pogorszenia jego właściwości technicznych. Niniejsza instrukcja może nie zawierać informacji o zmianach.
FR Le producteur se réserve le droit d'apporter des modifications dans la construction du produit à condition si elles ne portent atteinte à ses caractéristiques techniques. Les renseignements sur les modifications apportées peuvent ne pas être dans la présente notice.
ES El fabricante se reserva el derecho de introducir modificaciones en la construcción del producto, que no empeoran sus características técnicas. Datos sobre modificaciones introducidas pueden no aparecer en esta instrucción.
DE Der Hersteller behält sich das Recht auf Designänderungen, die die technischen Merkmale und Funktionen nicht negativ beeinflussen, vor.
RU Производитель оставляет за собой право вносить изменения в конструкцию изделия, не ухудшающие его технические характеристики. Сведения о внесенных изменениях могут отсутствовать в настоящей инструкции.
IT Il produttore si riserva il diritto di apportare modifiche al design del prodotto, non peggiorando le sue caratteristiche tecniche. Informazioni sulle modifiche apportate potrebbero non essere presenti in questo manuale.
CN 制造商保留对产品的设计更改的权利，一切改良旨在增强产品的技术性能。改良处若未出现在手册中，敬请谅解
CZ Výrobce si vyhrazuje právo na takové změny v designu produktu, které nebudou mít za následek zhoršení technických vlastností. Informace o změnách nemusí být v návodu uvedeny.

1

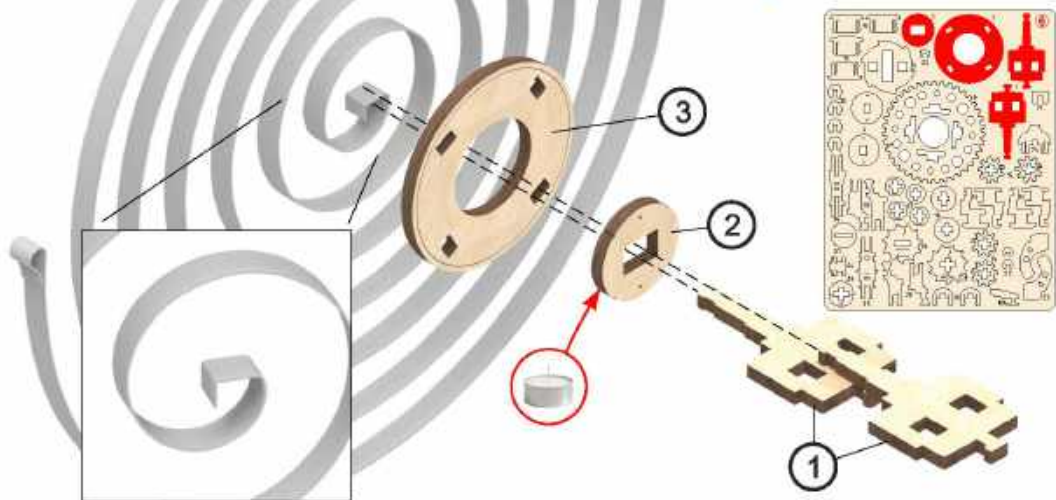

2

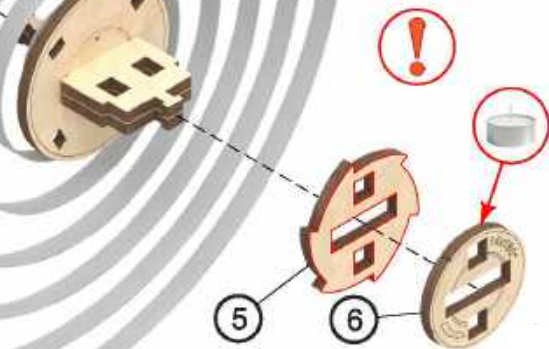
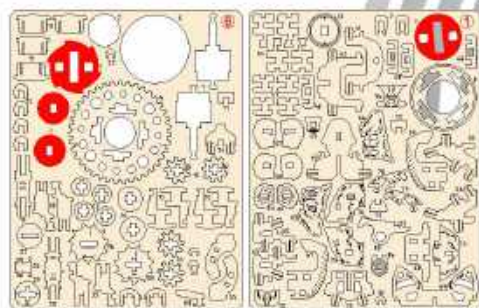
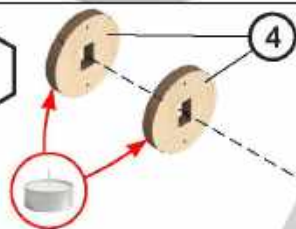

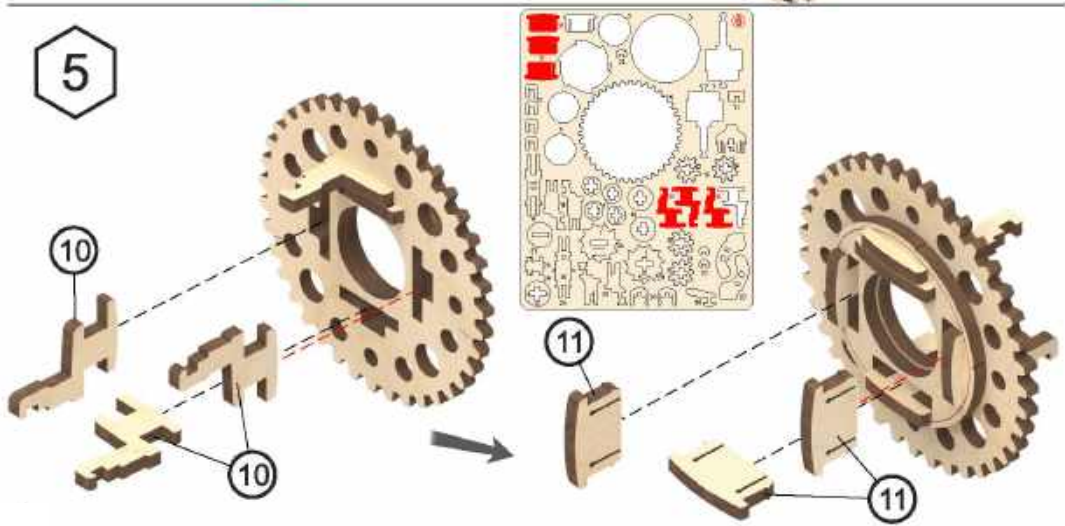
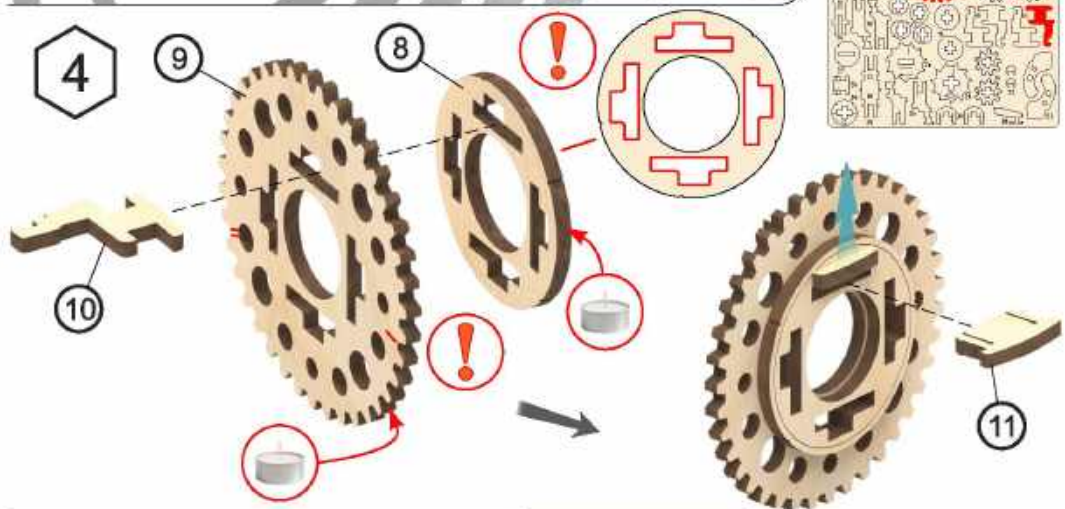
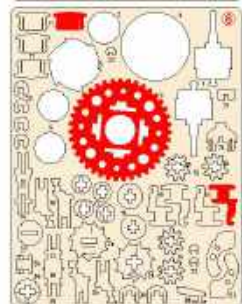
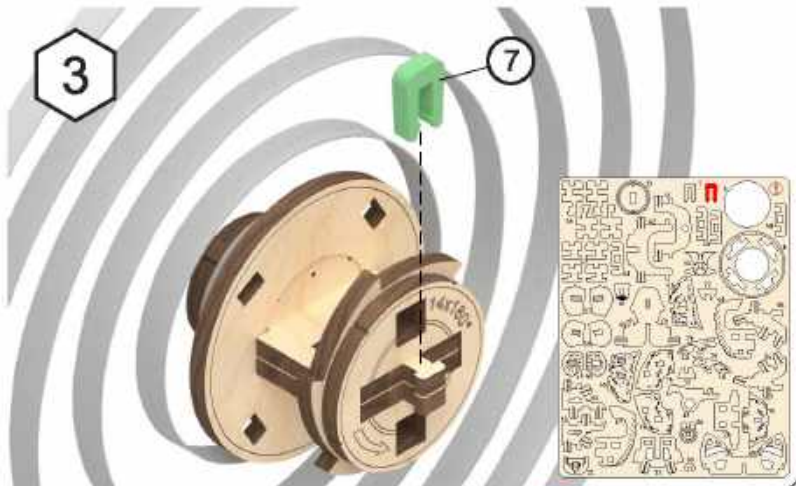

6

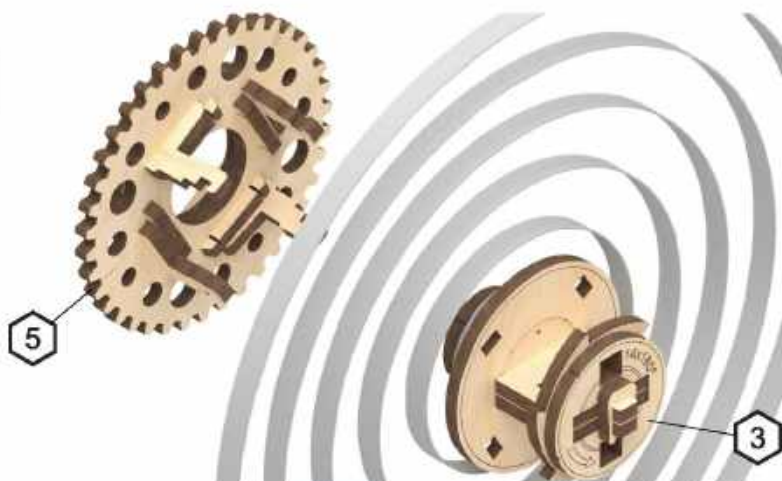

7

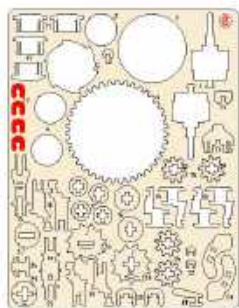
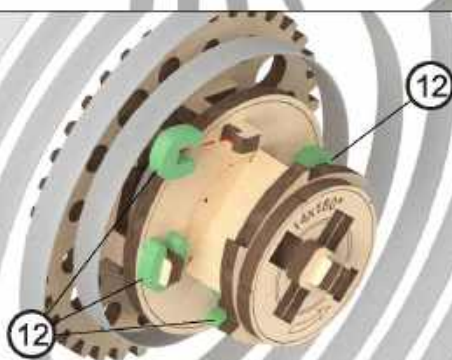

8

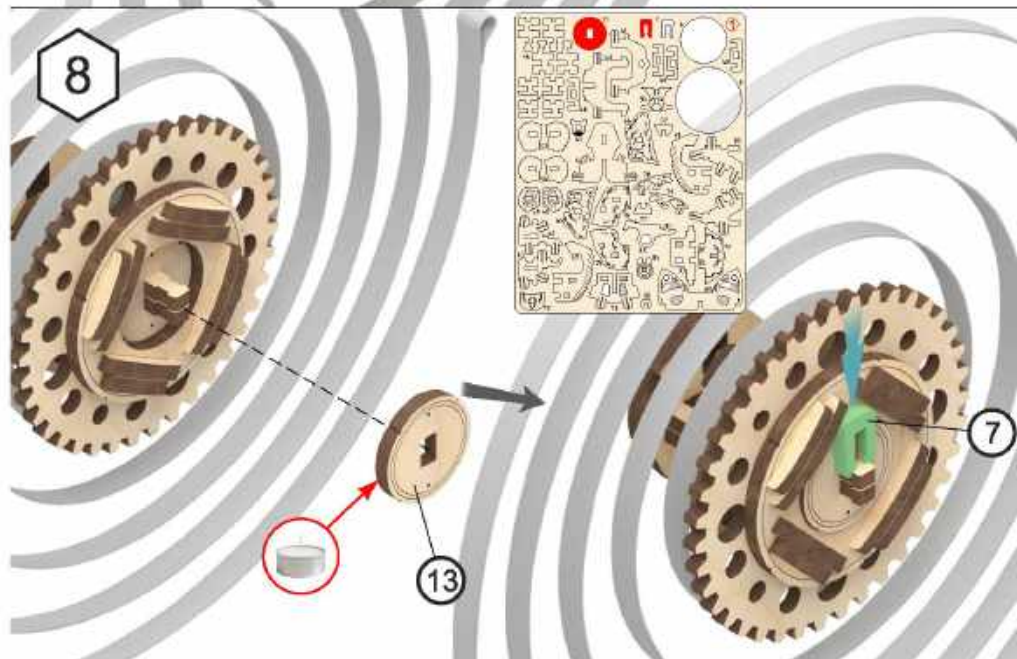

9

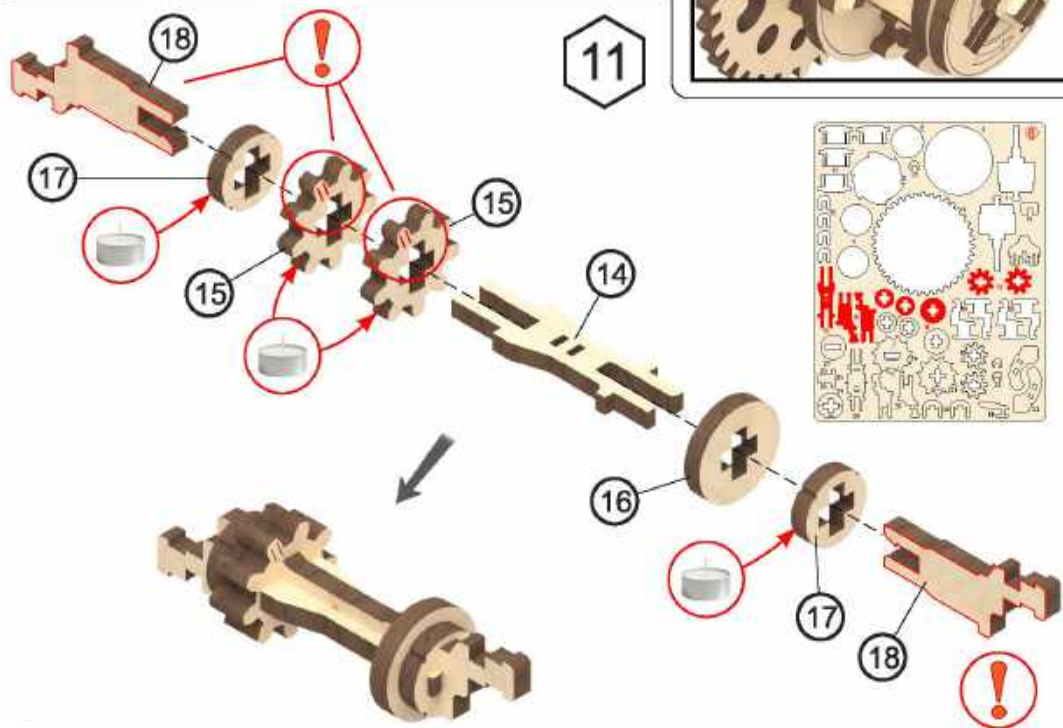
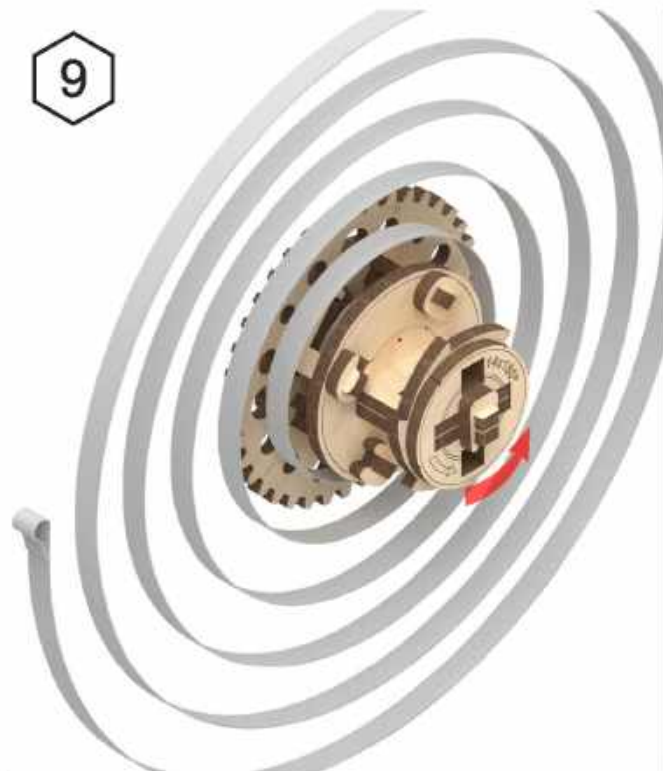

12

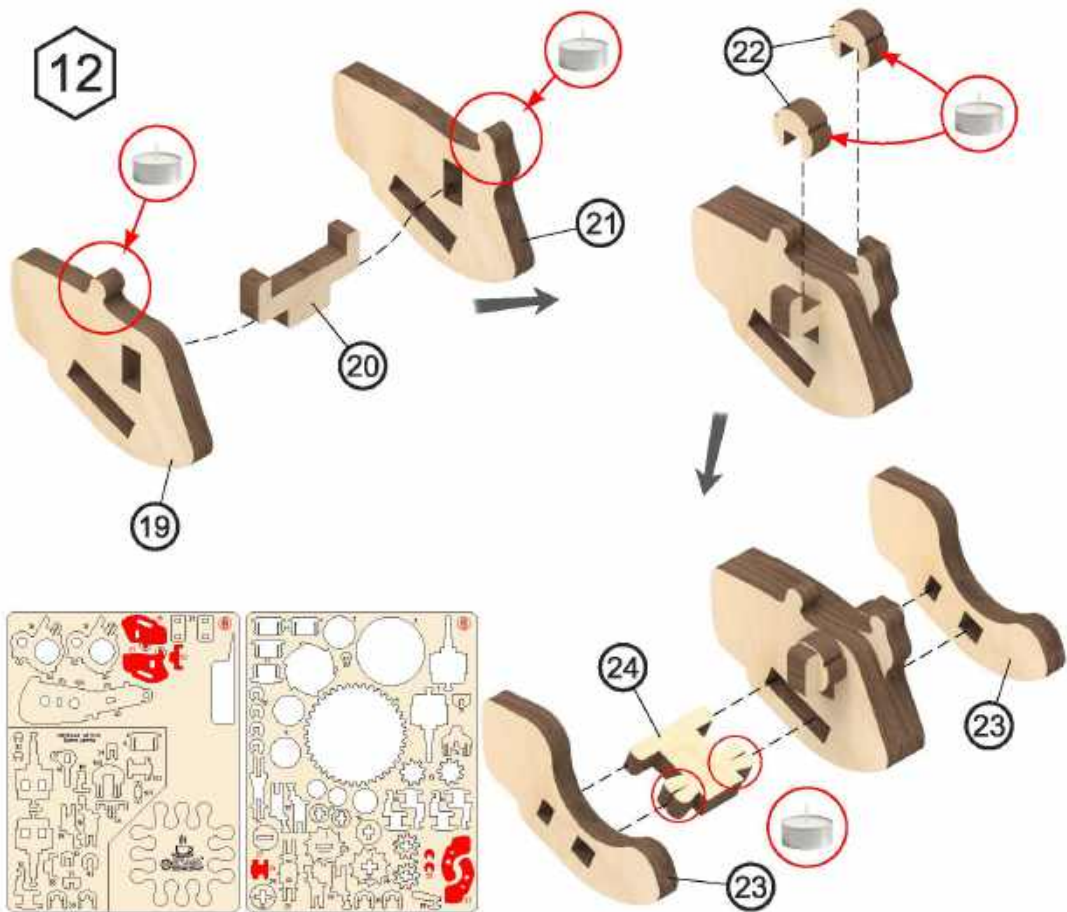

13

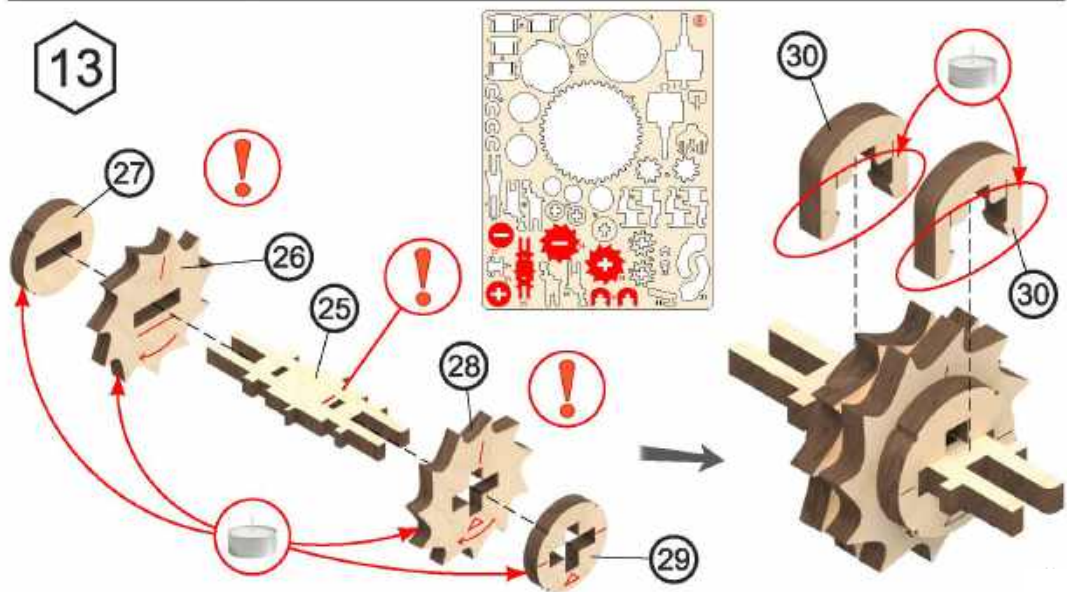

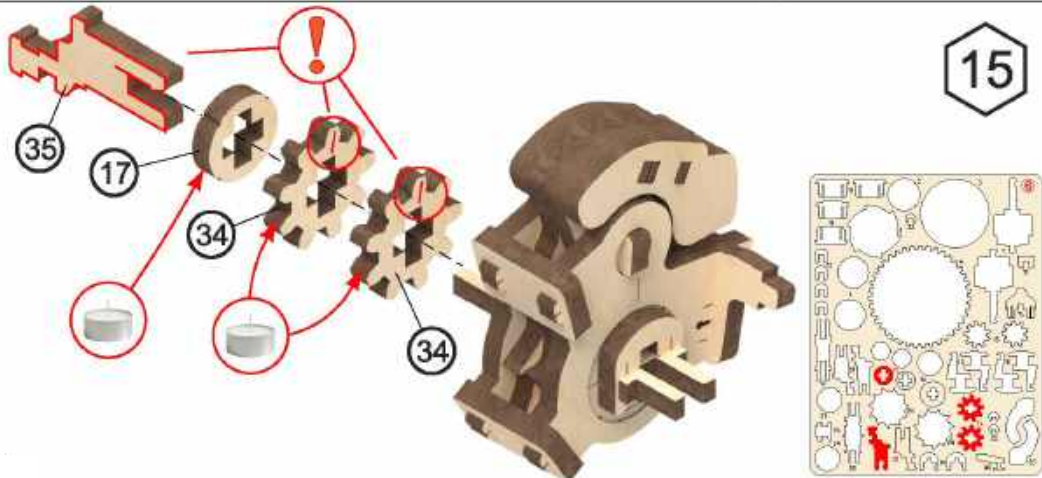
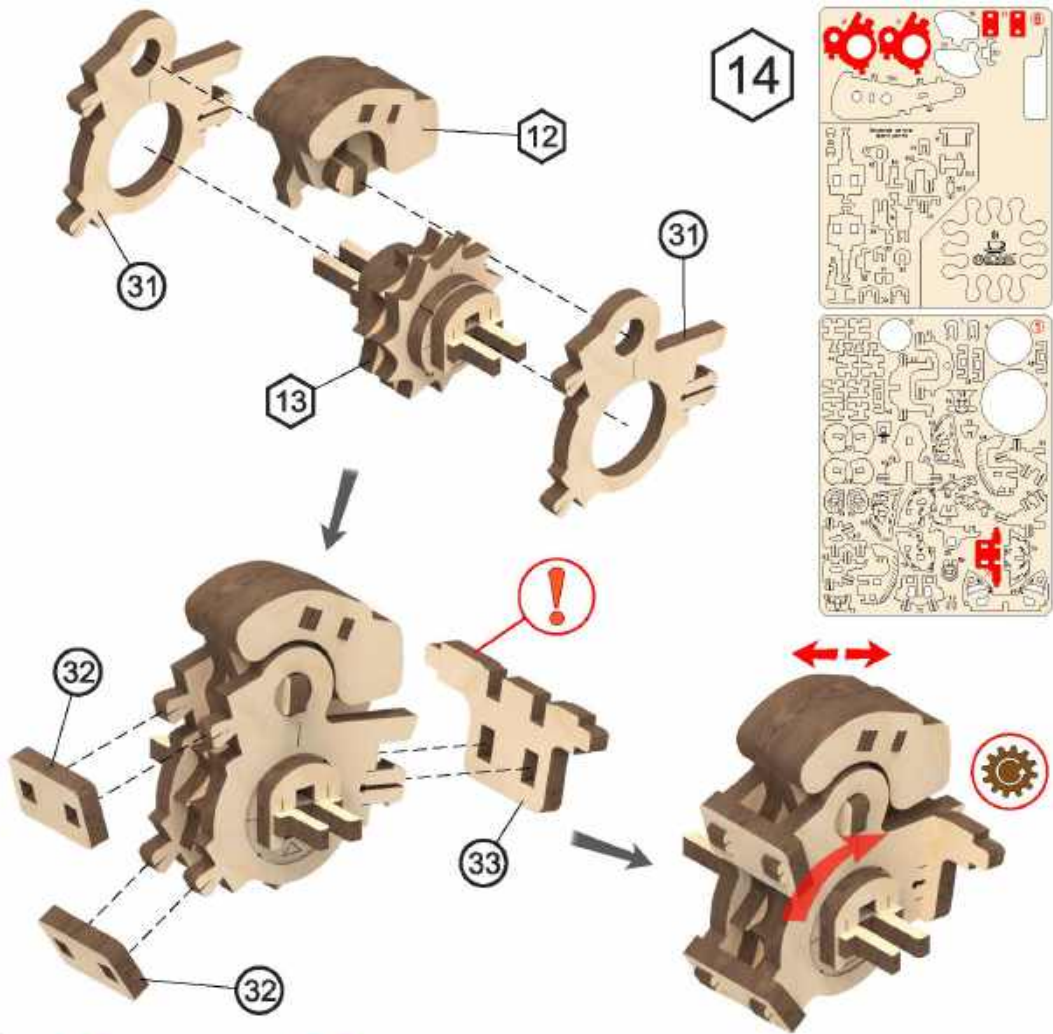

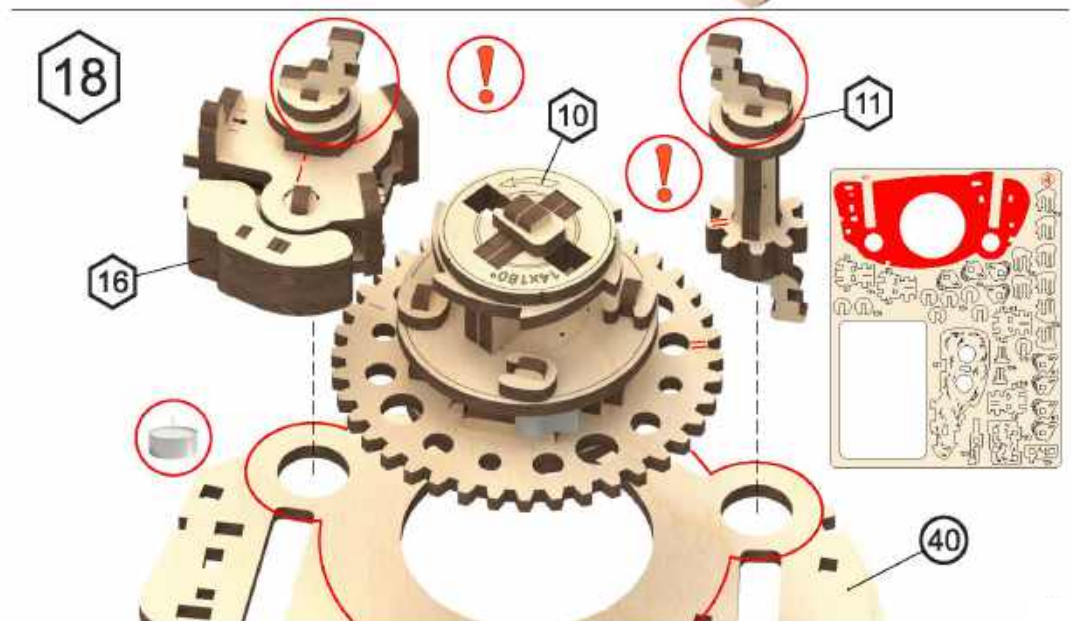
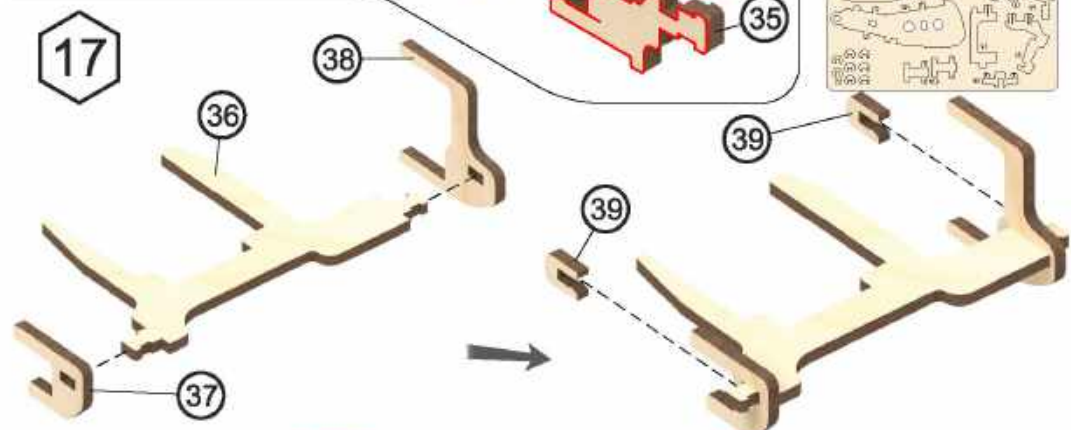
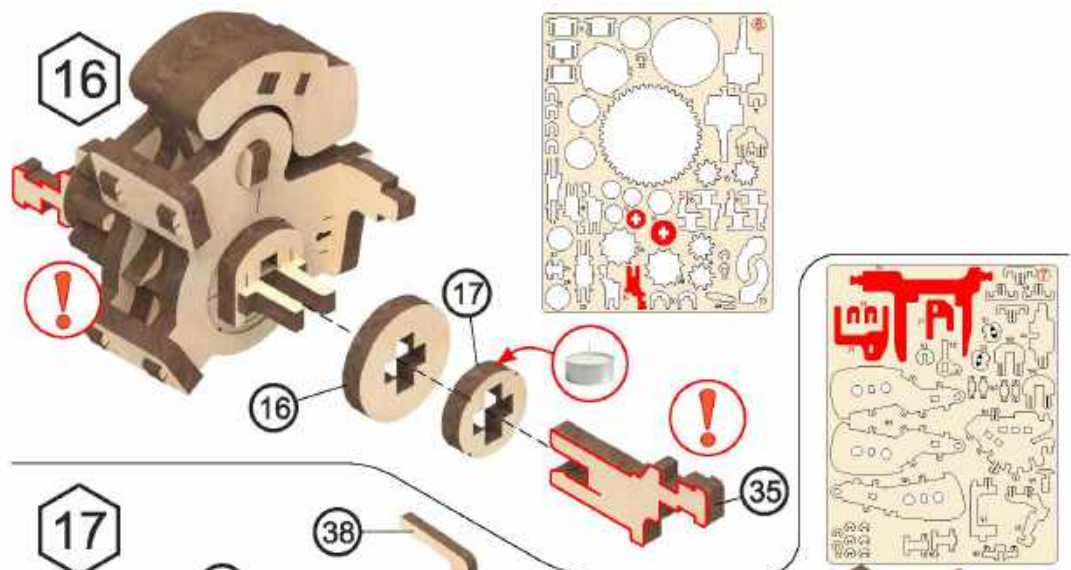

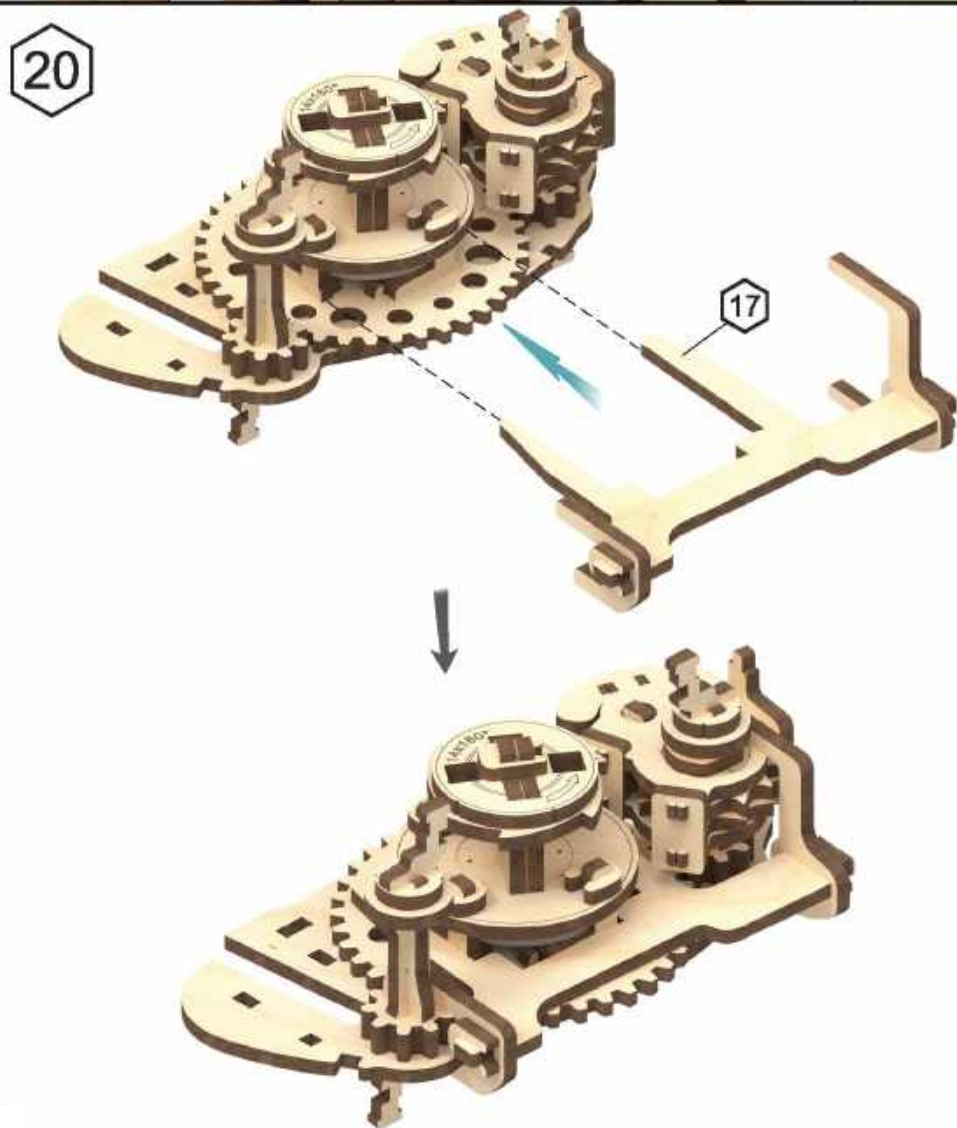

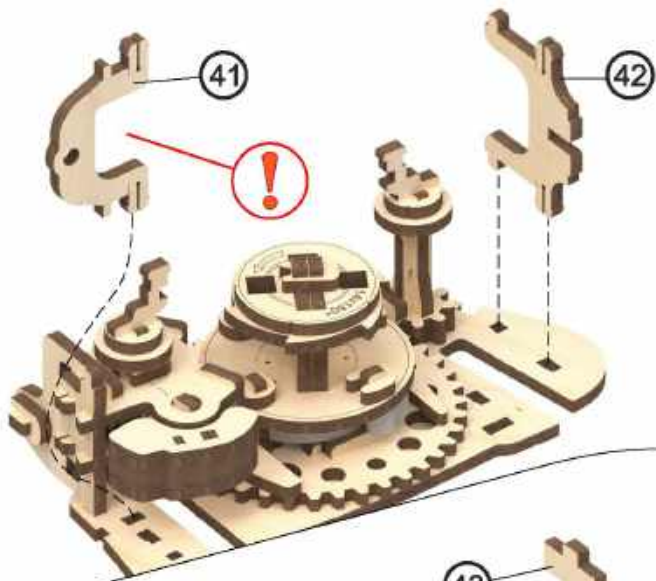

22

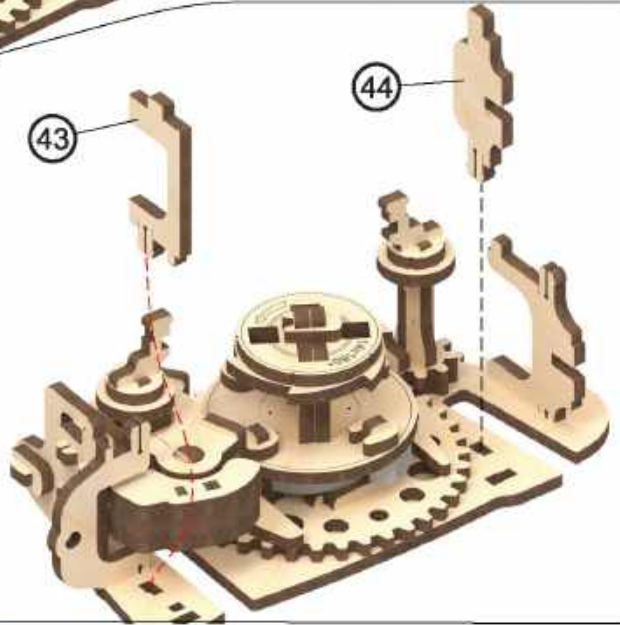
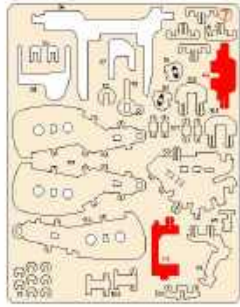

23

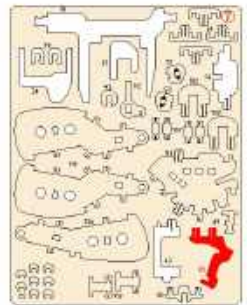
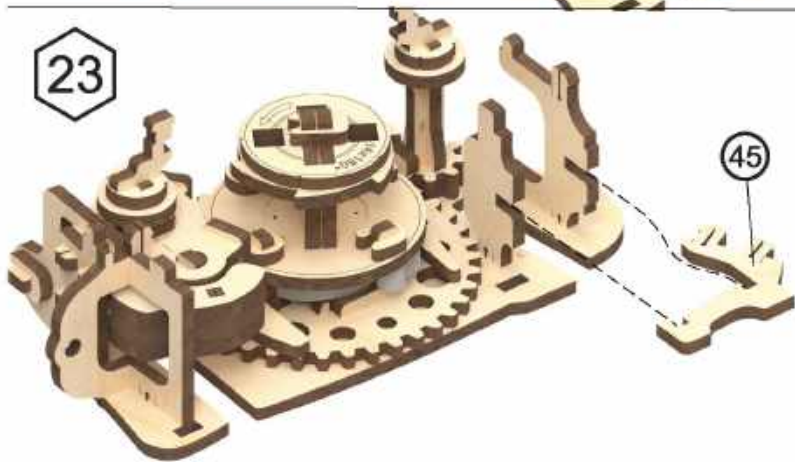

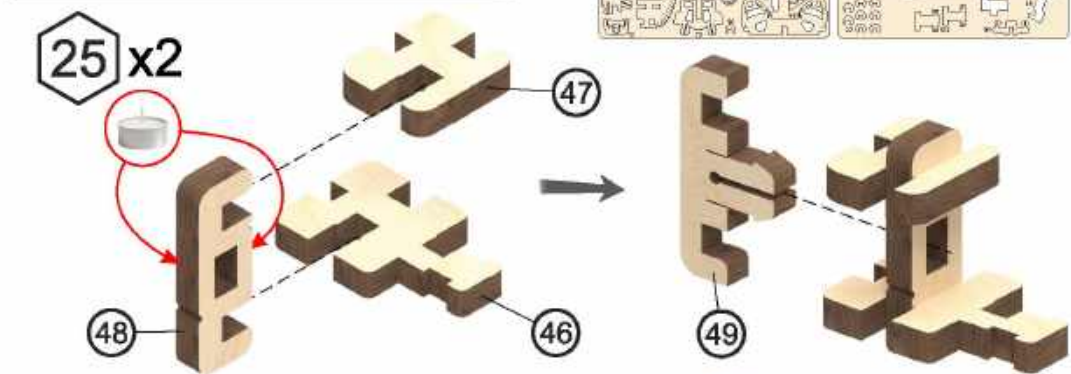
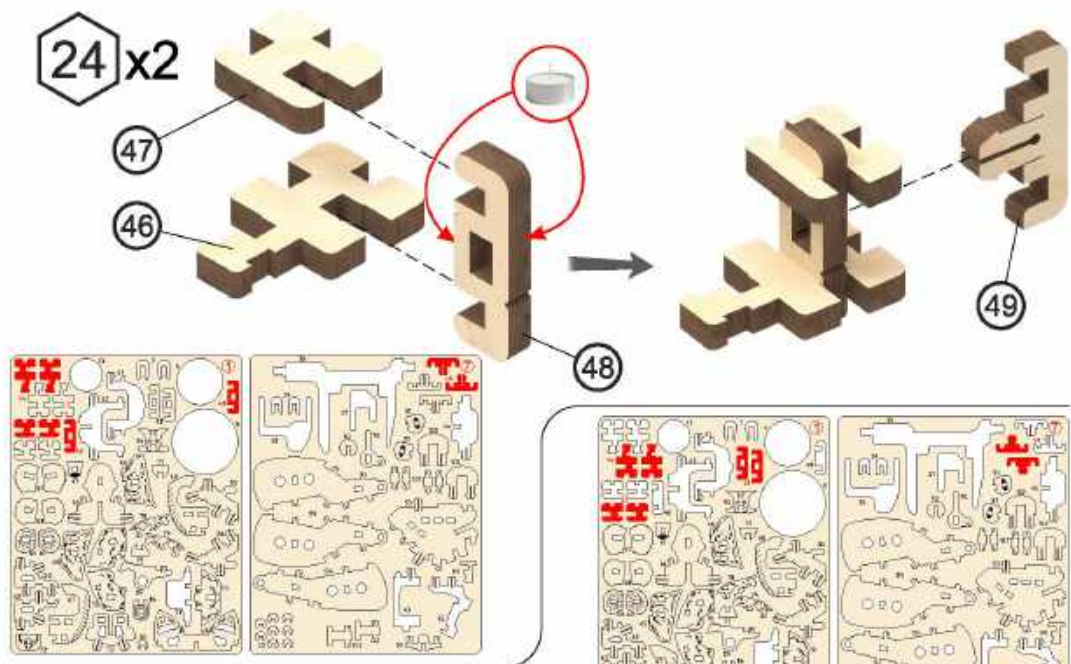

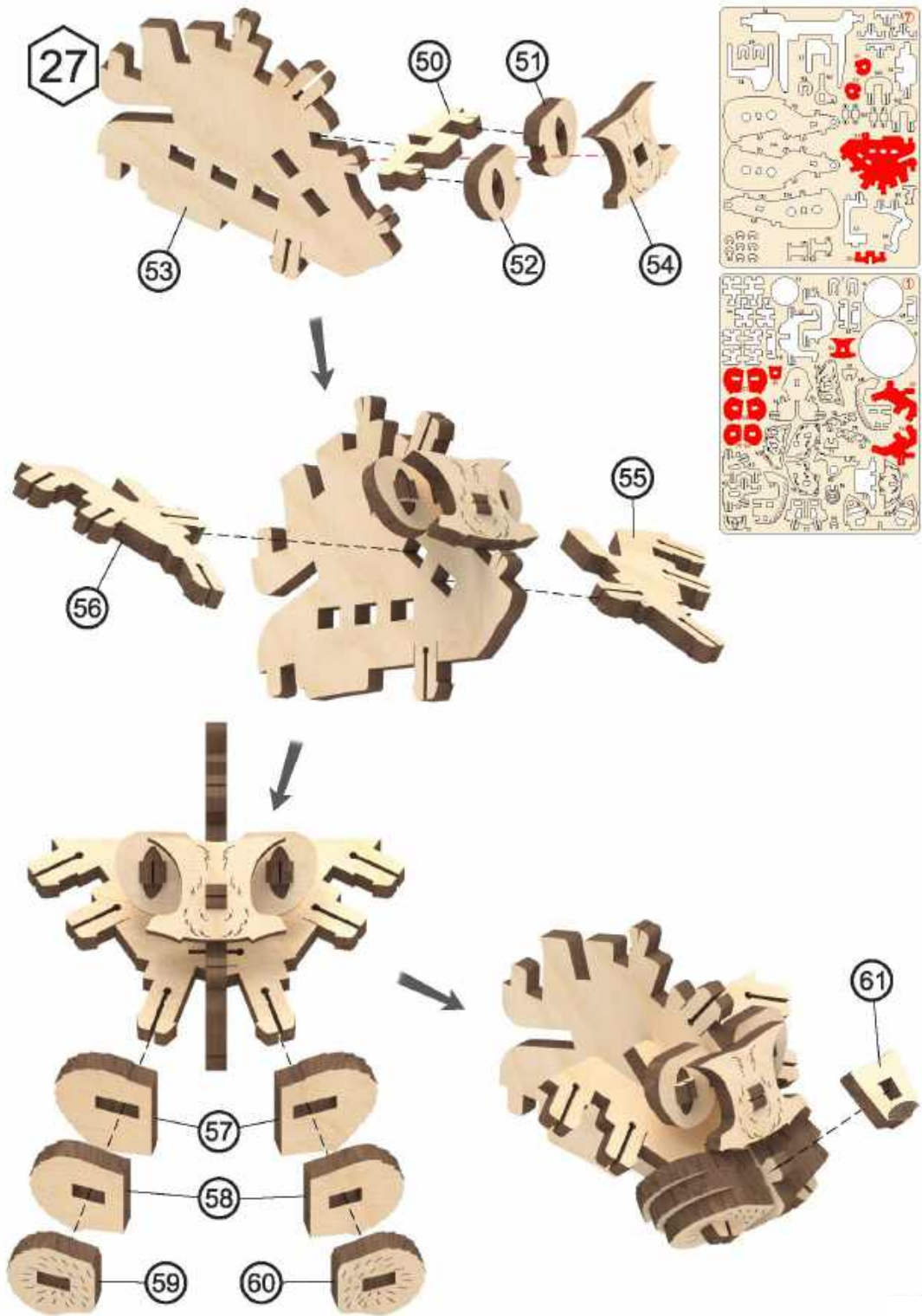

28

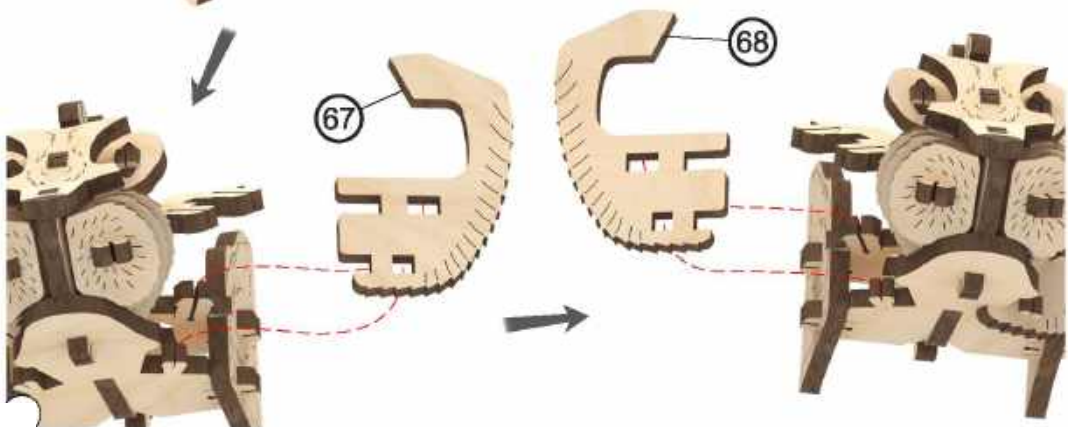
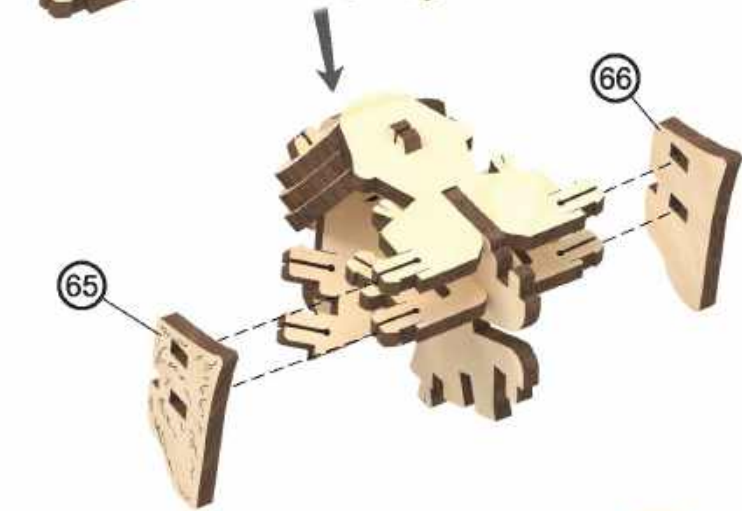
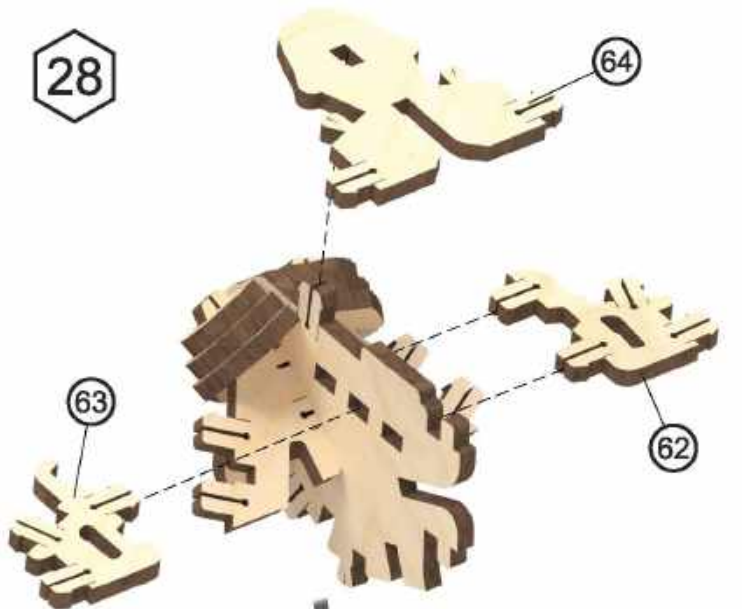

29

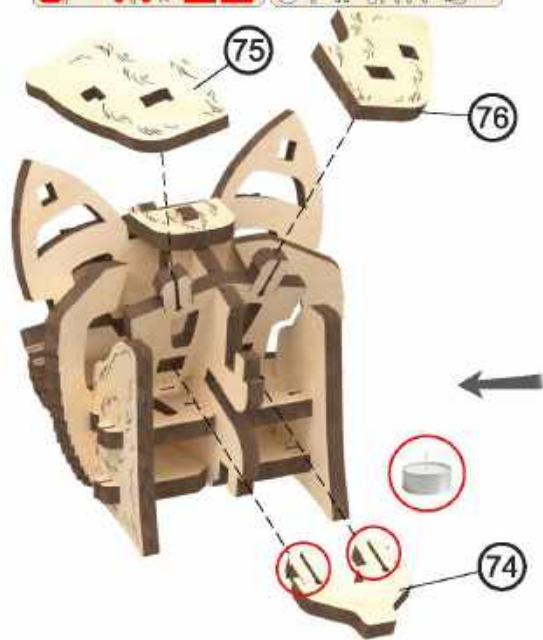
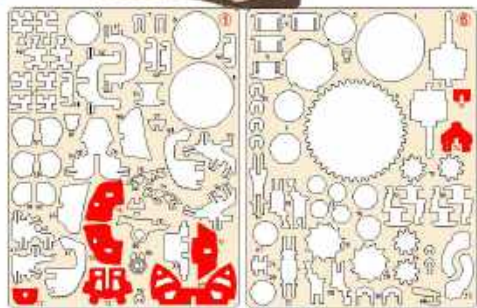
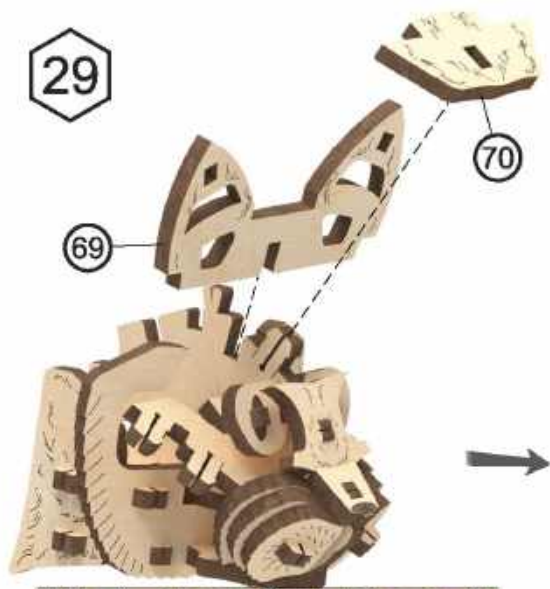

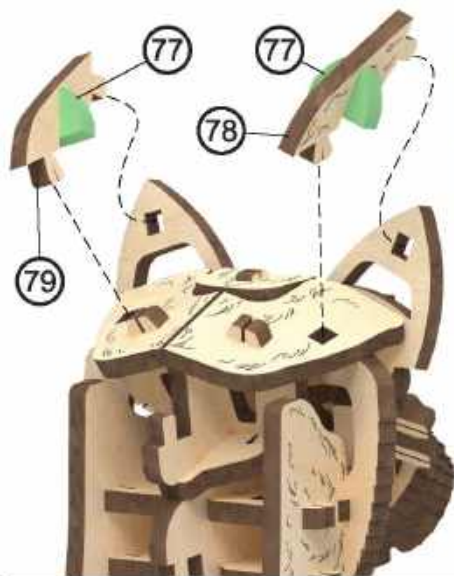

30



32

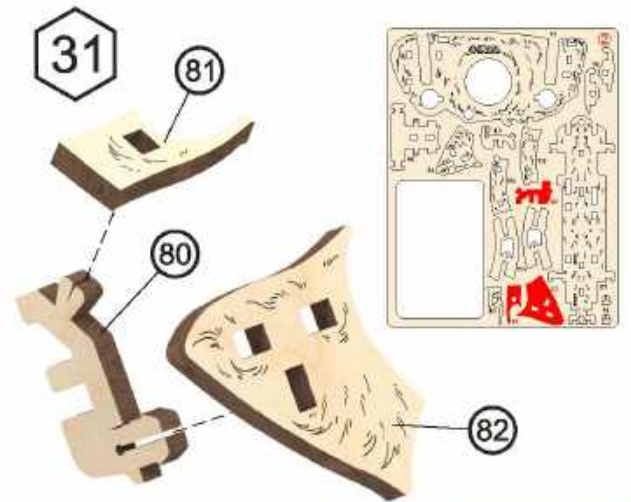

31

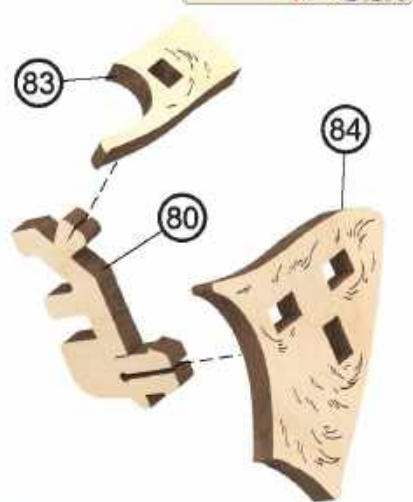
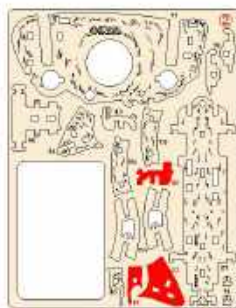

83

84

80

82

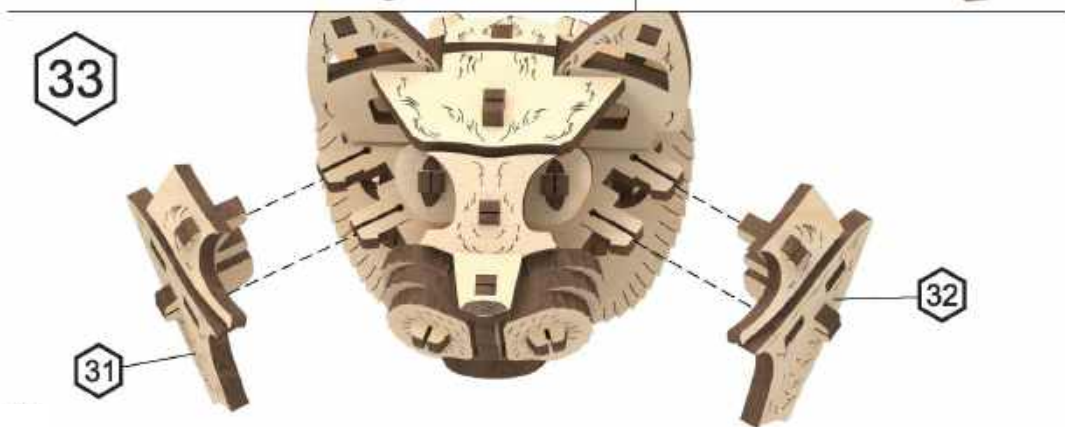

33

31

32

34



35

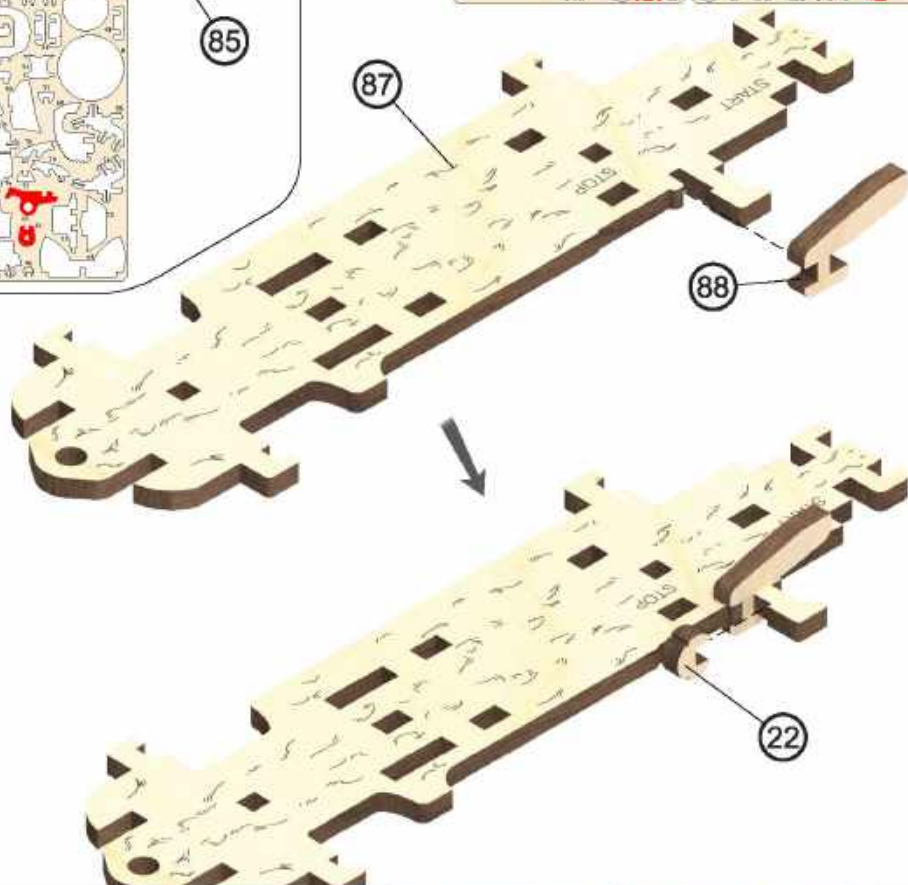
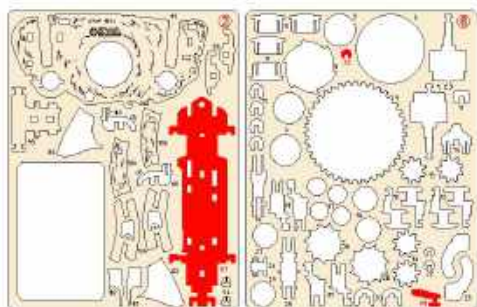

36

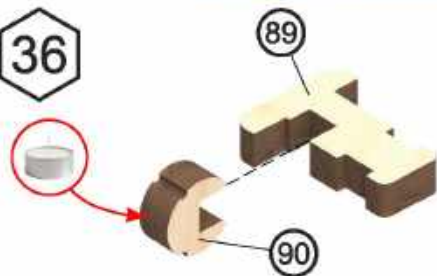

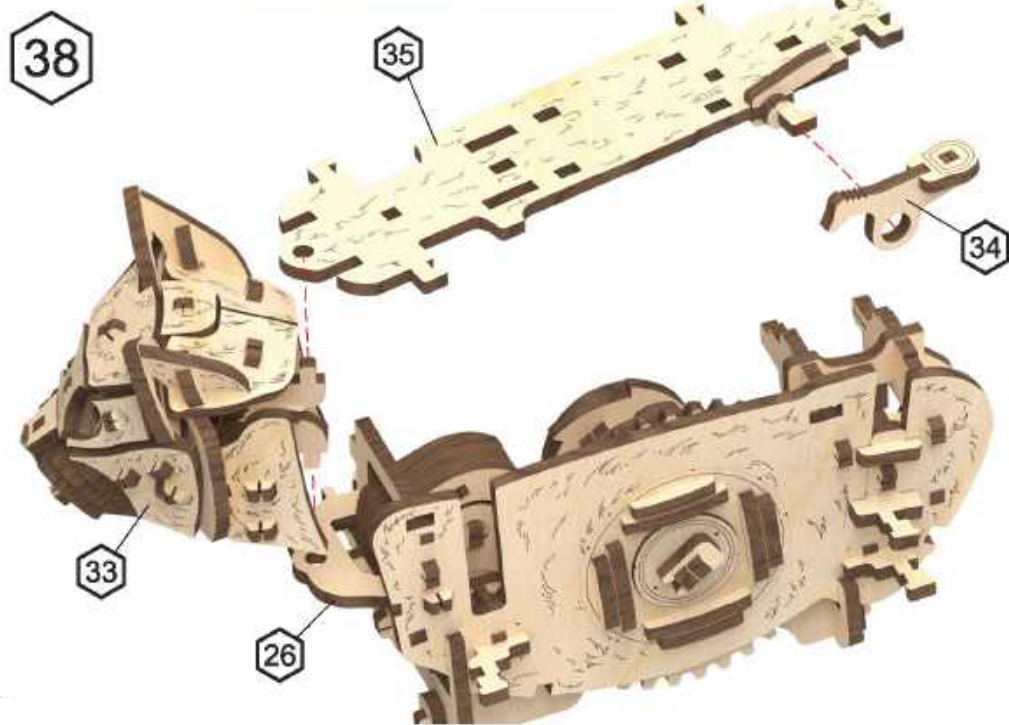
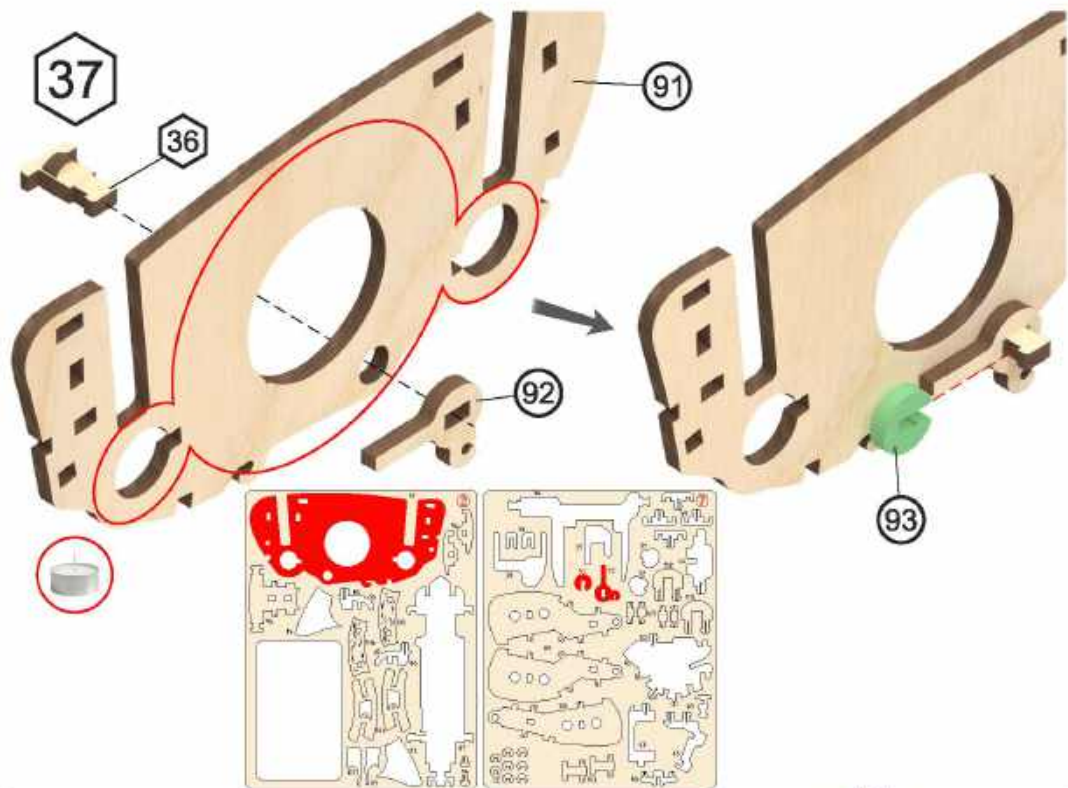

39

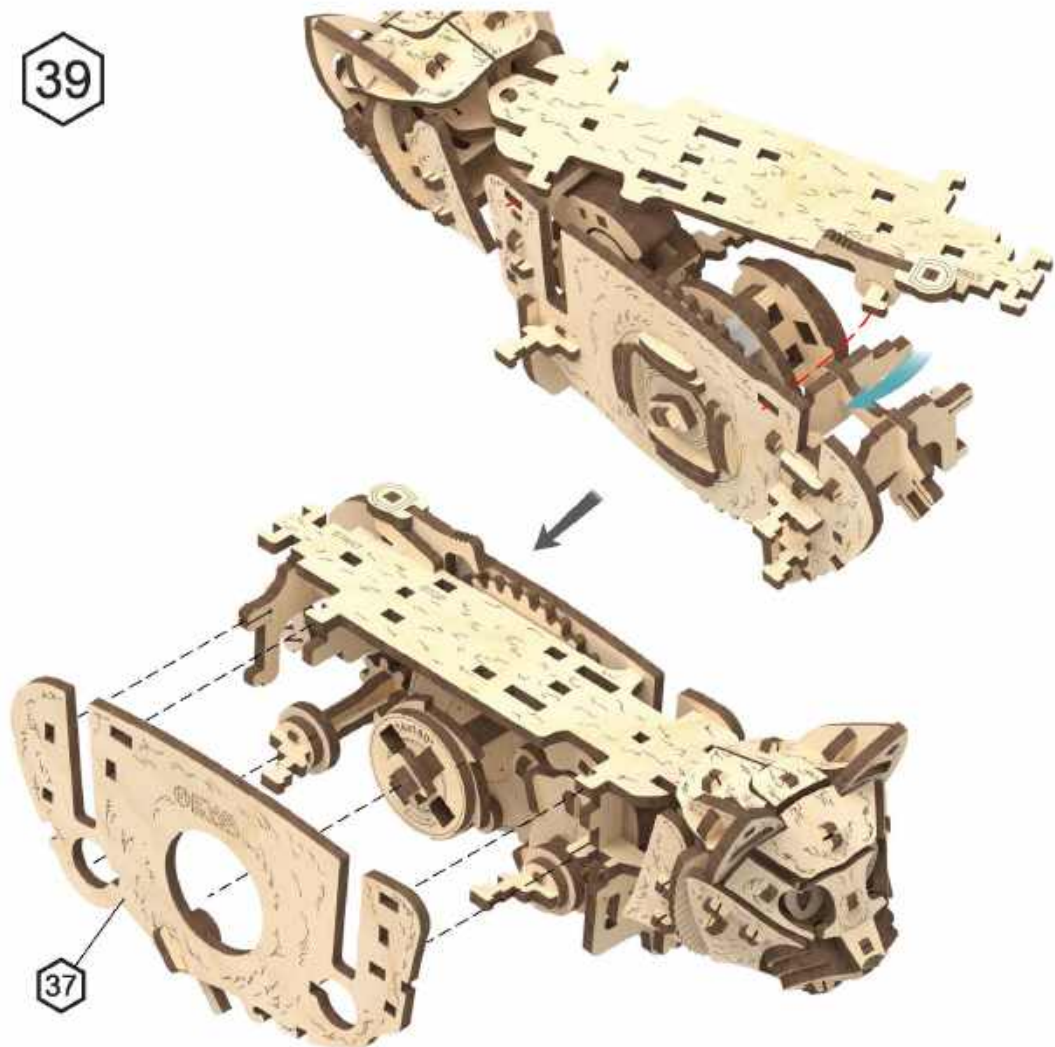

40

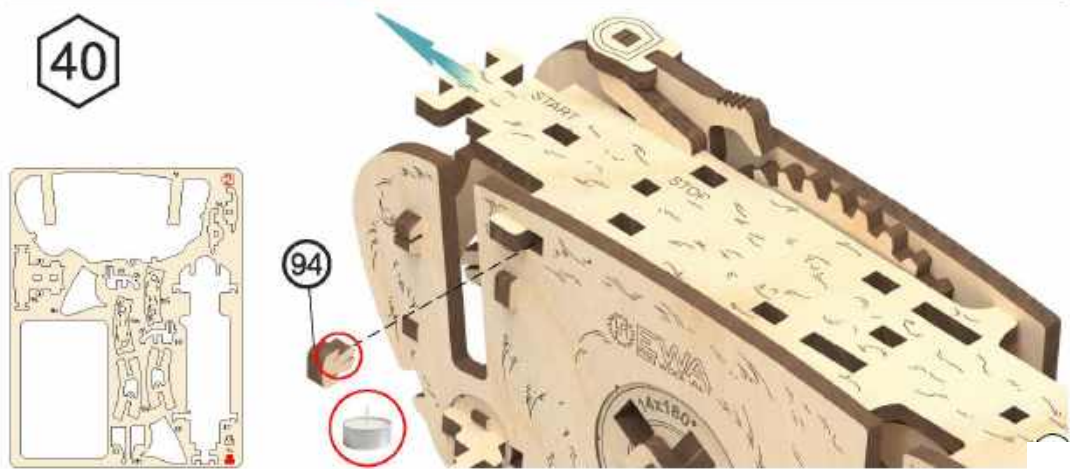

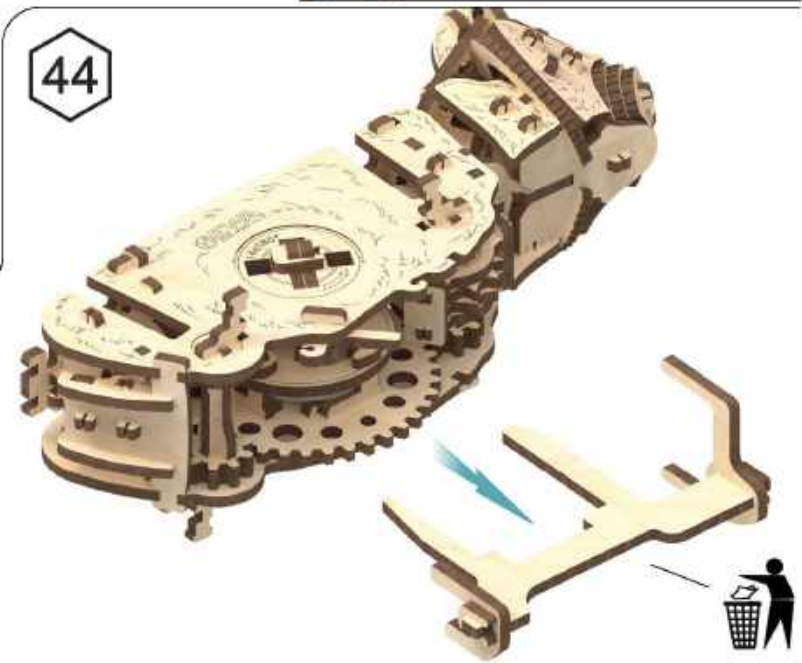
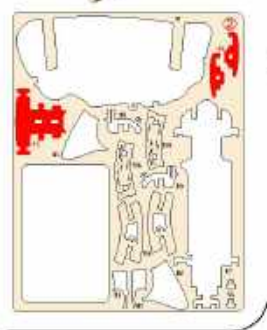
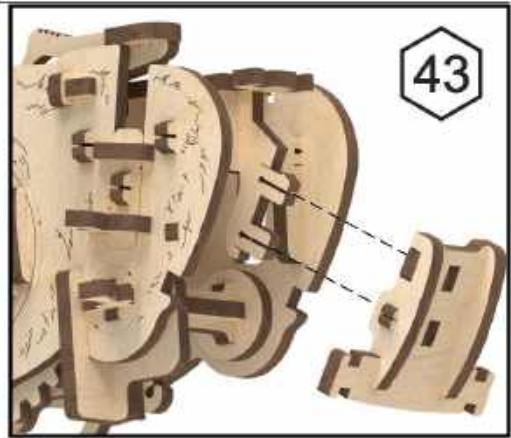
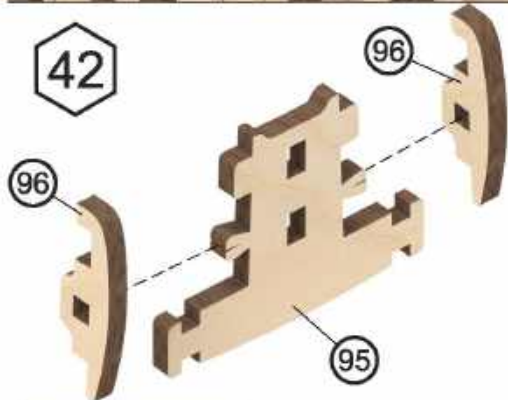
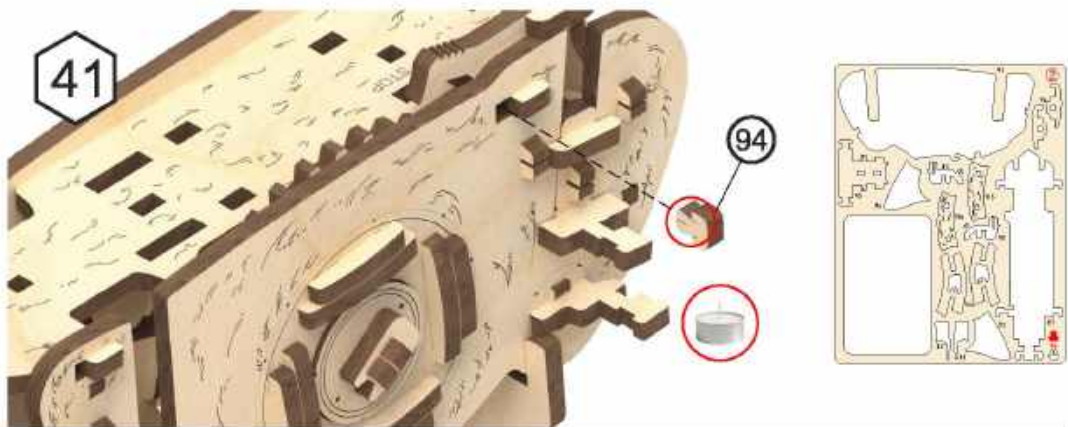

45

98

99



46



97

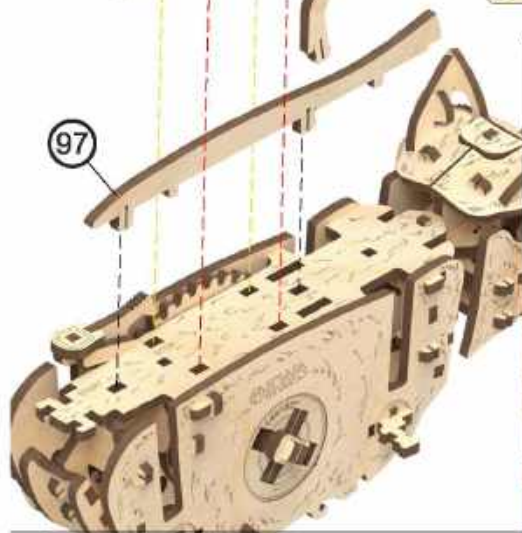

100

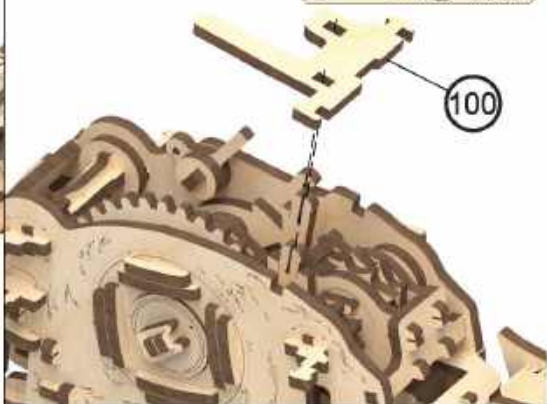

47

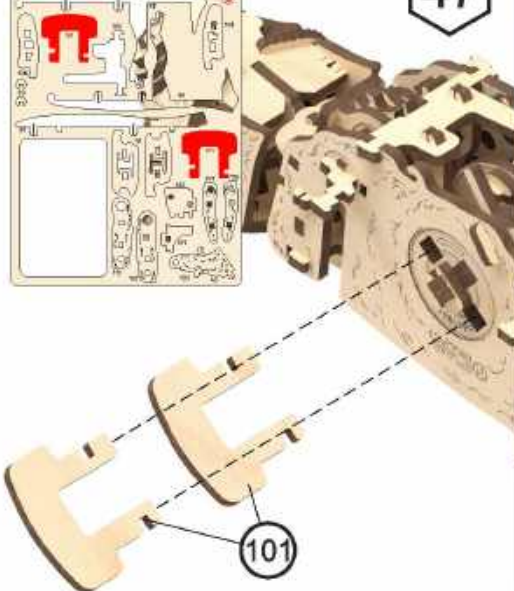
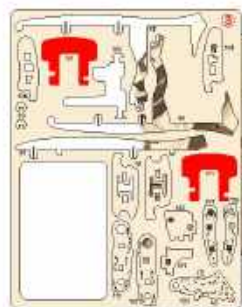

48

102

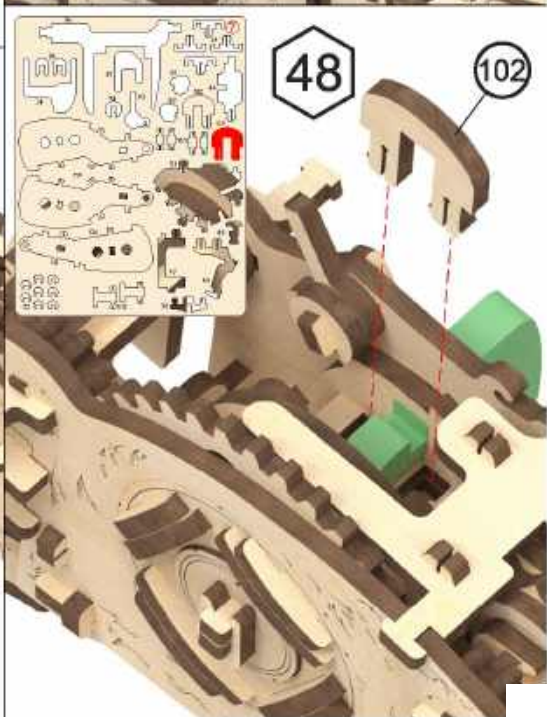

49

102

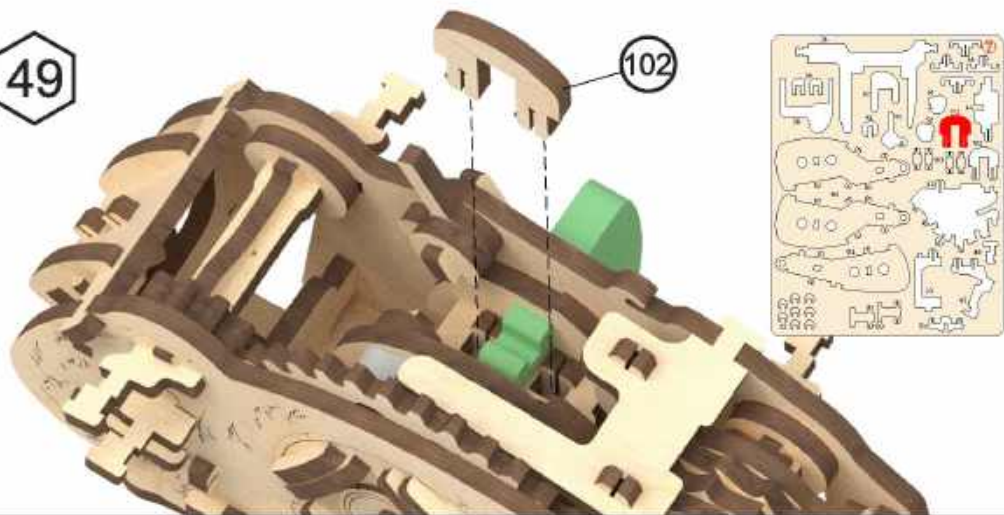

50

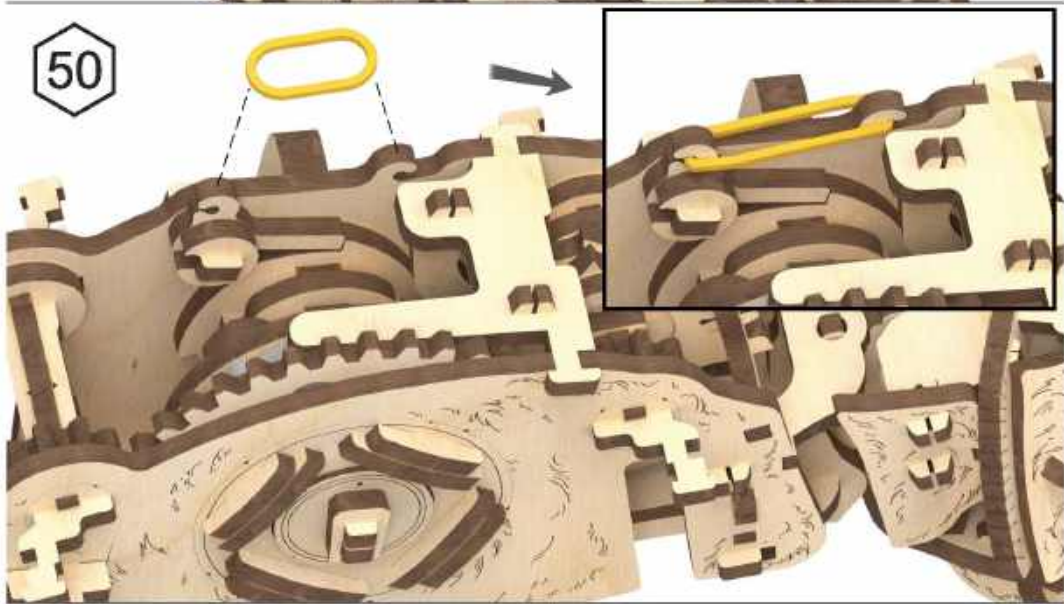

51

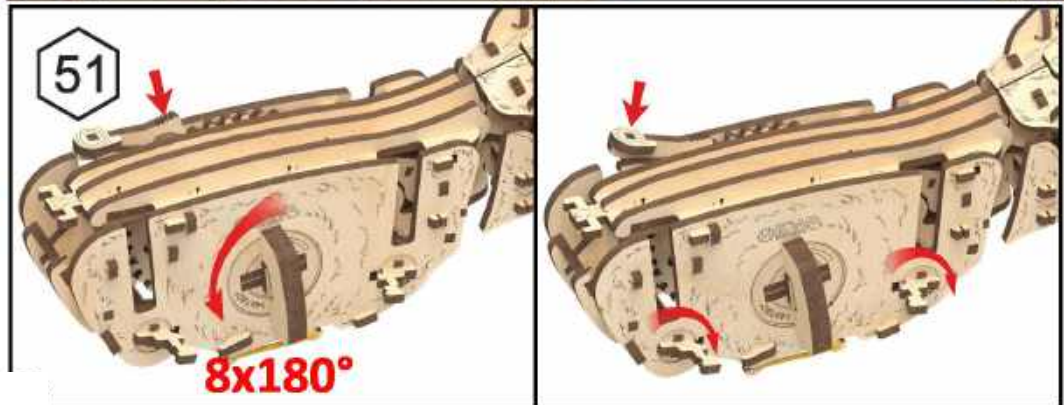

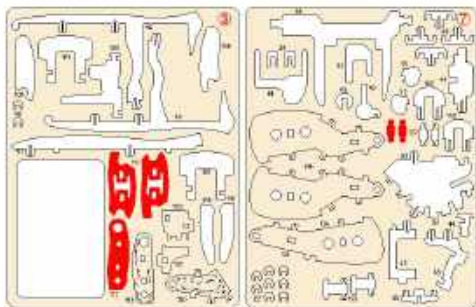
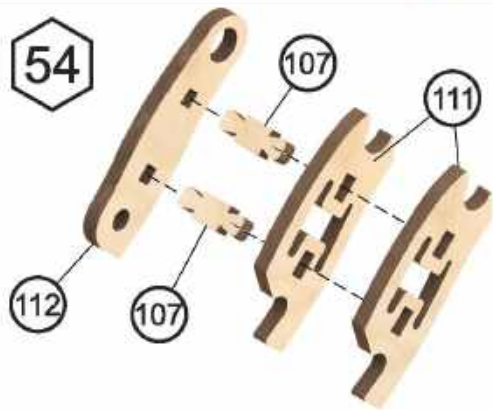
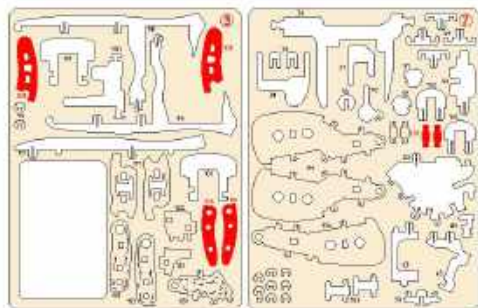
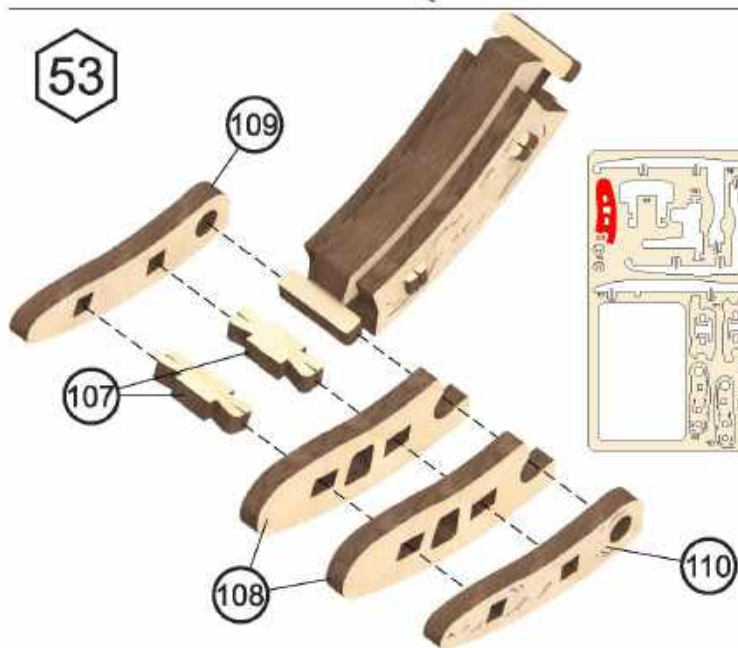
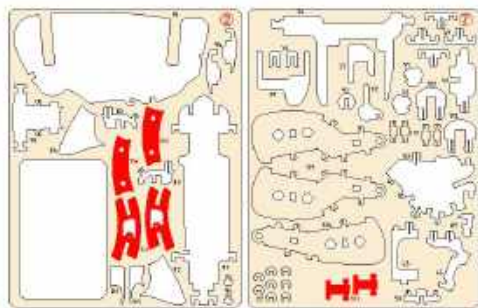
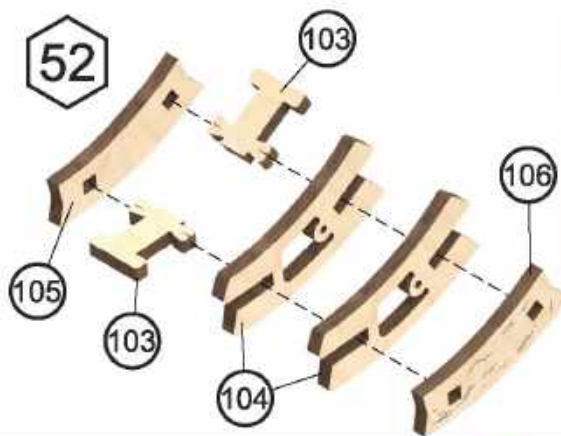

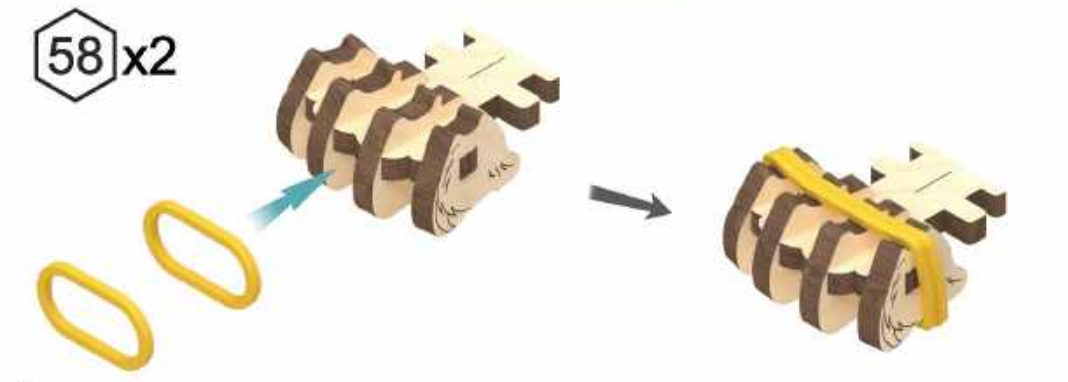
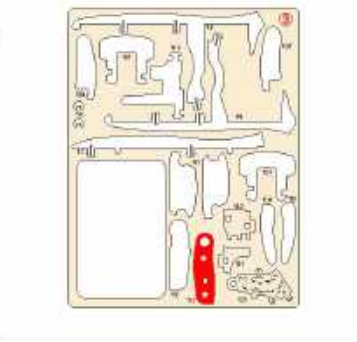
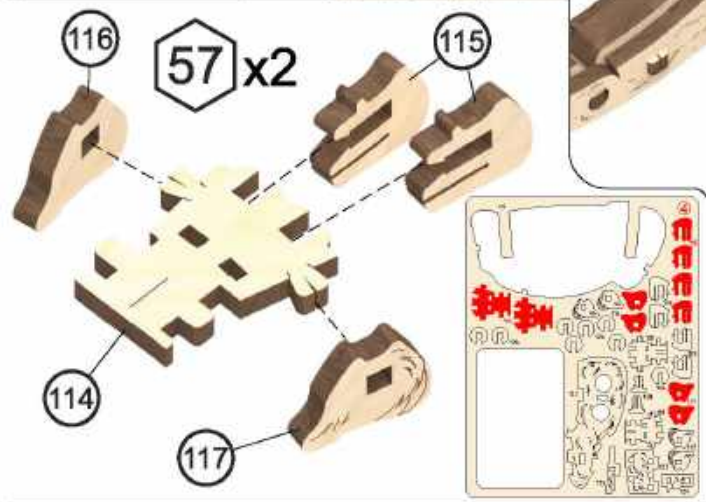
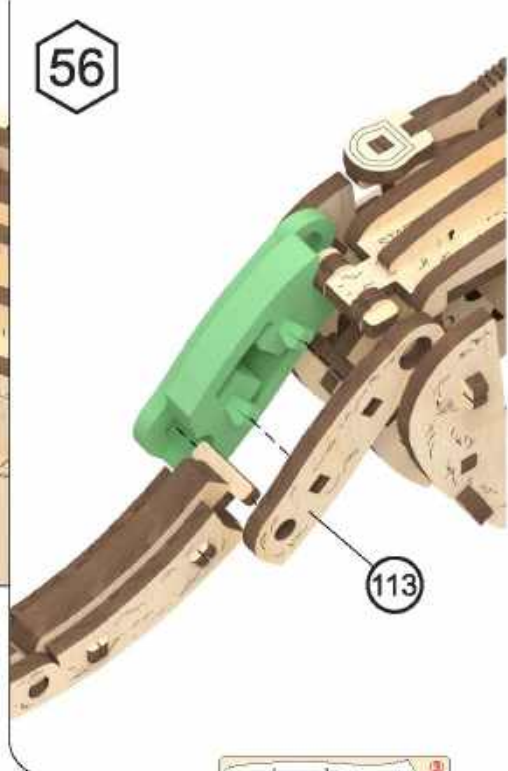
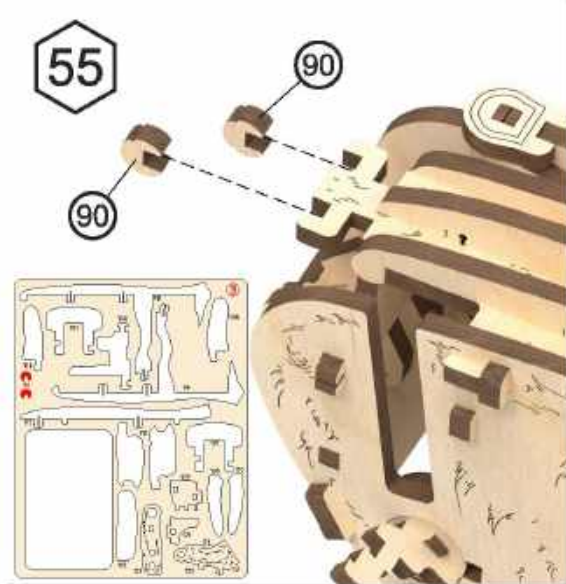

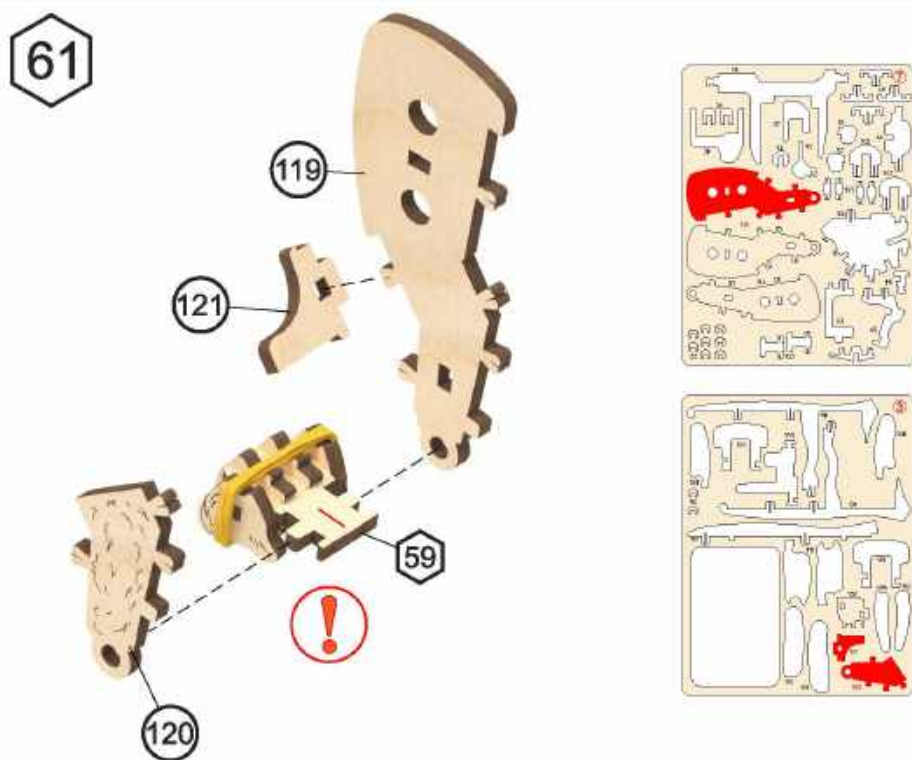
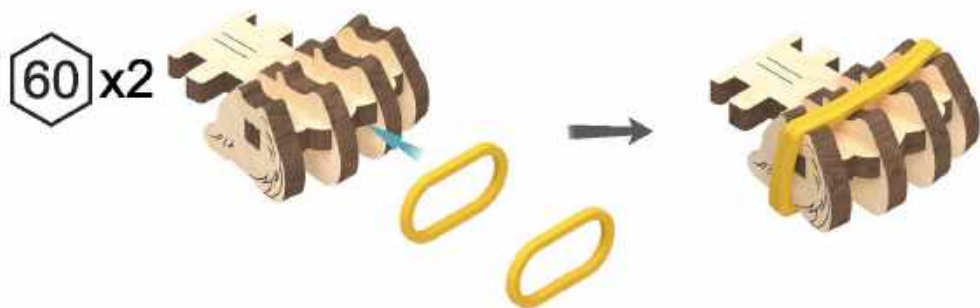
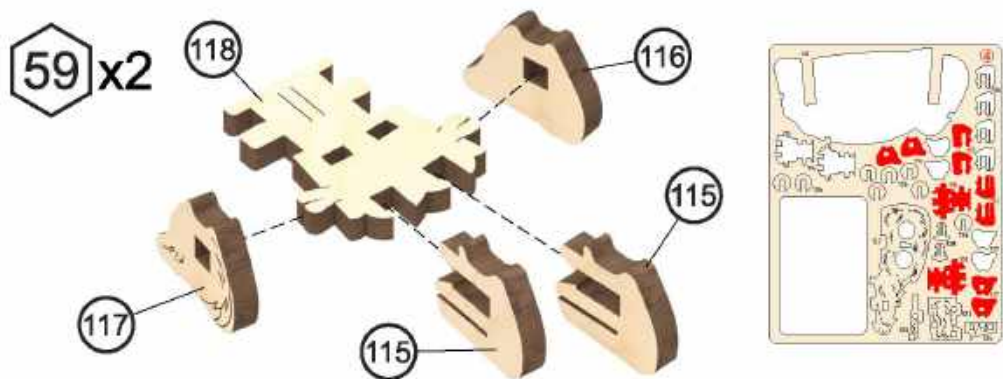

62

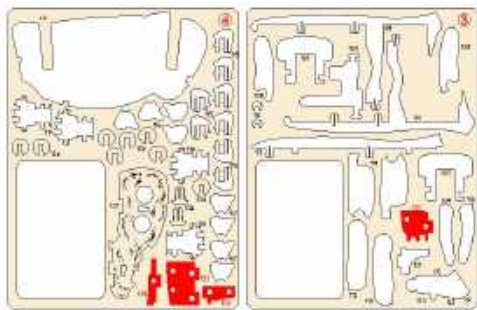
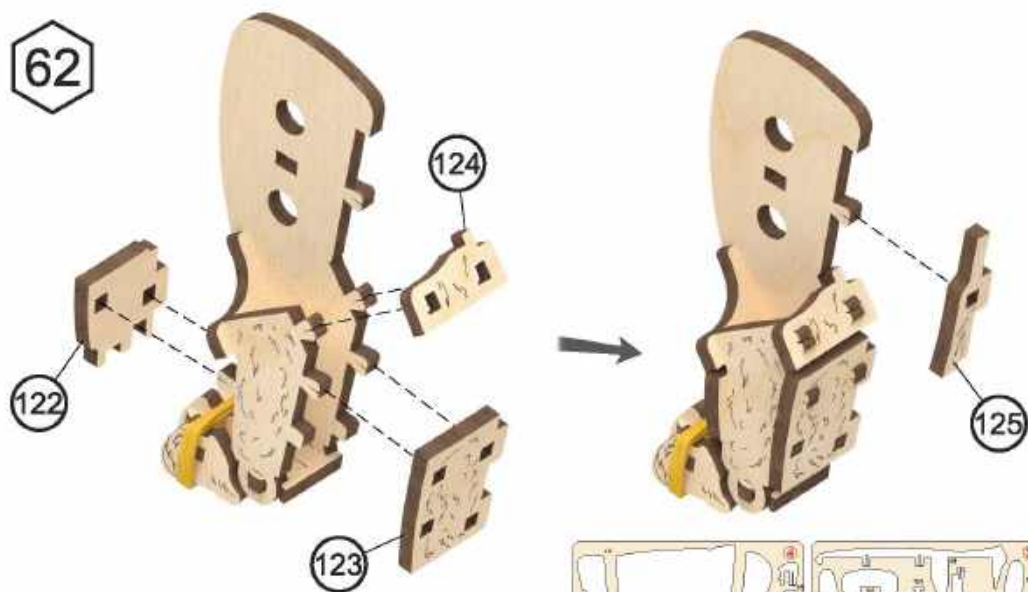

63

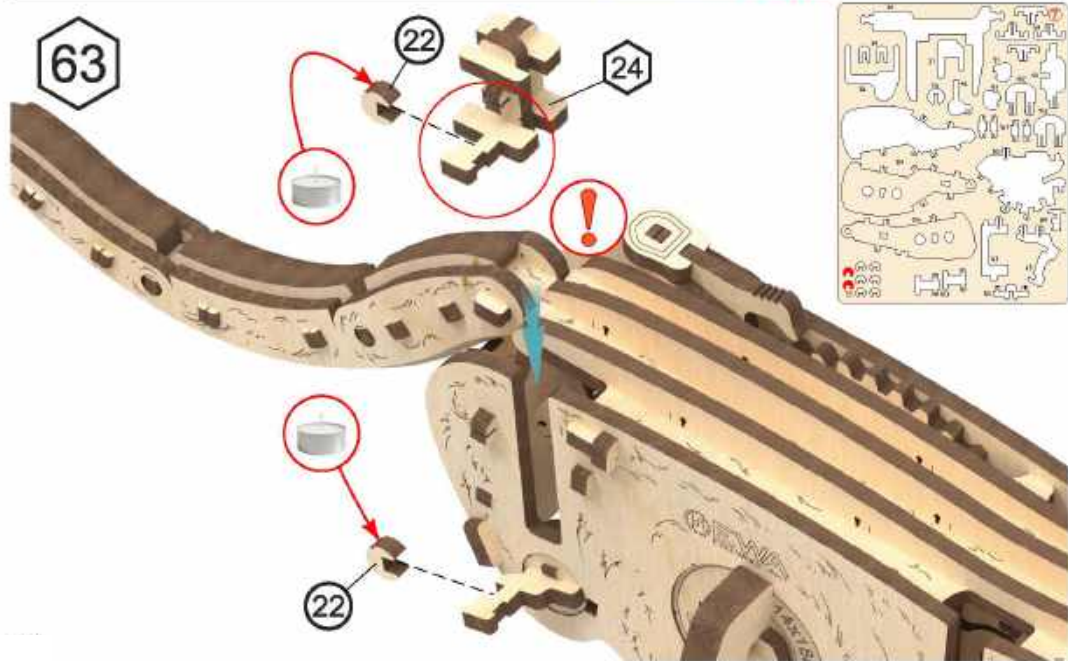

64

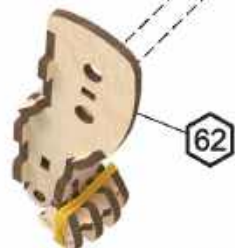

65



66

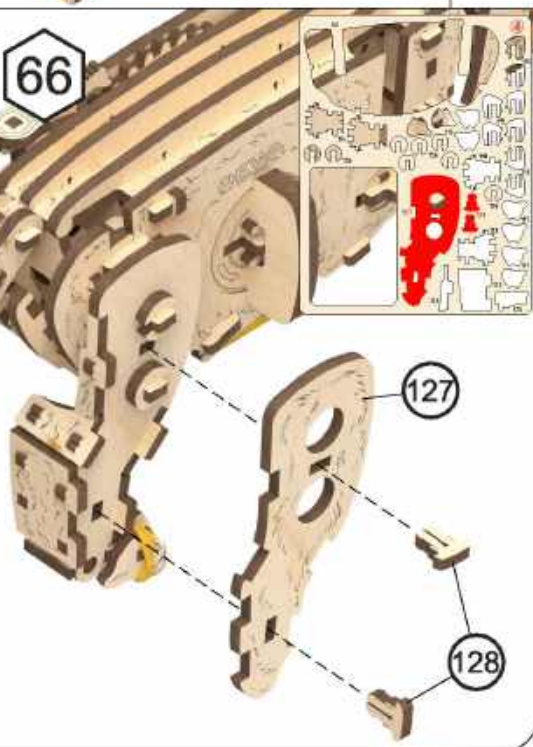

67

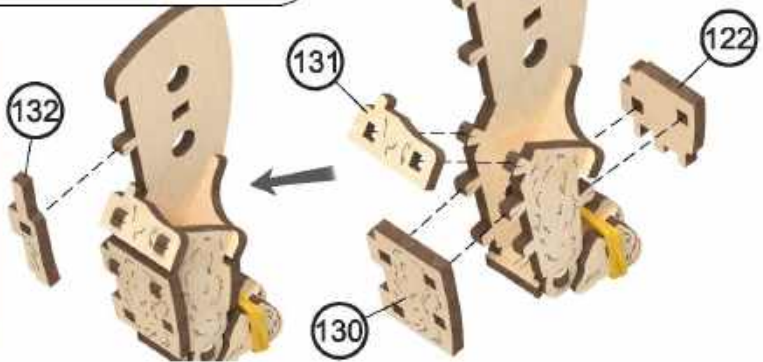
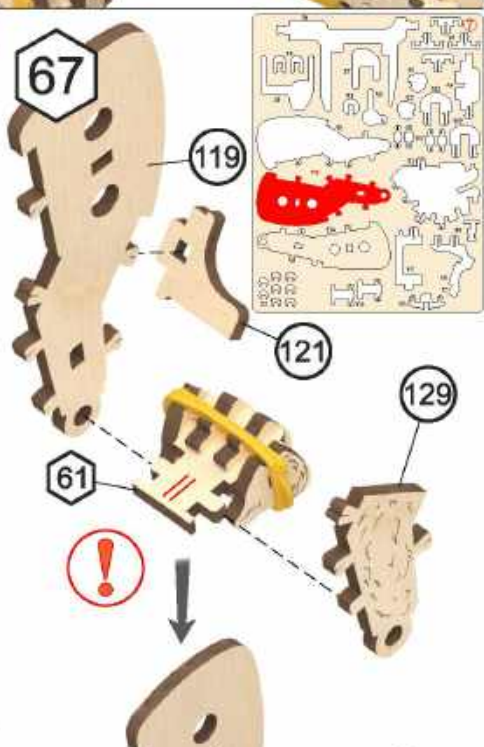

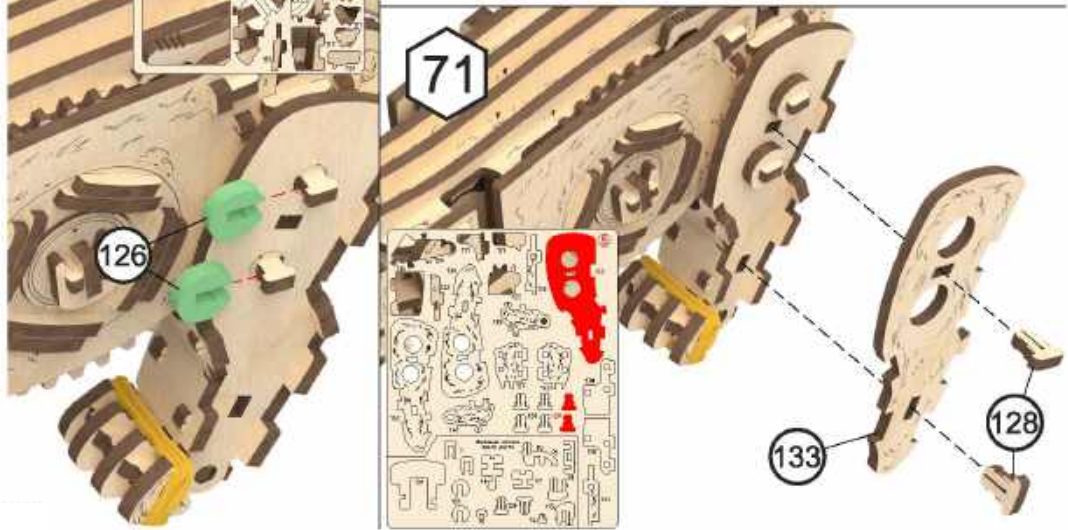
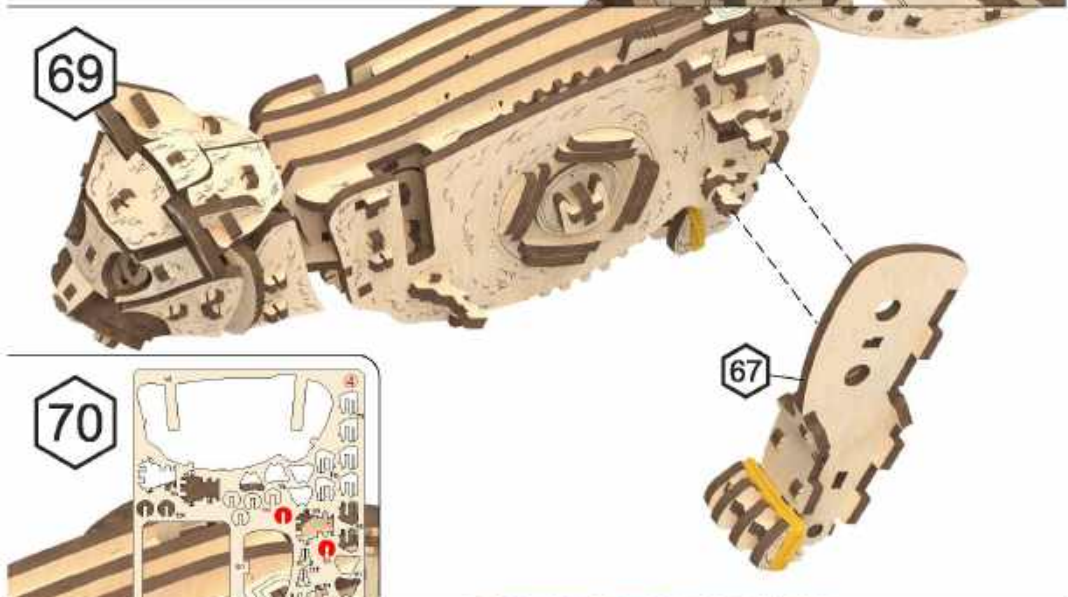
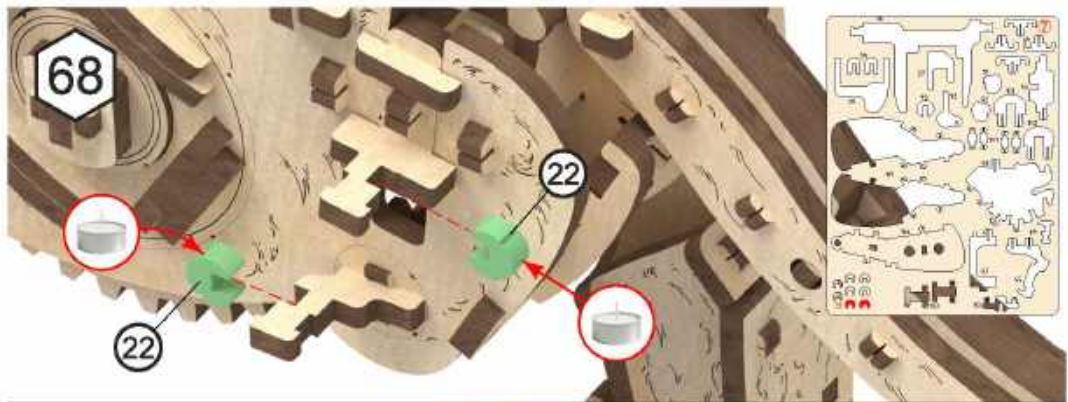

72

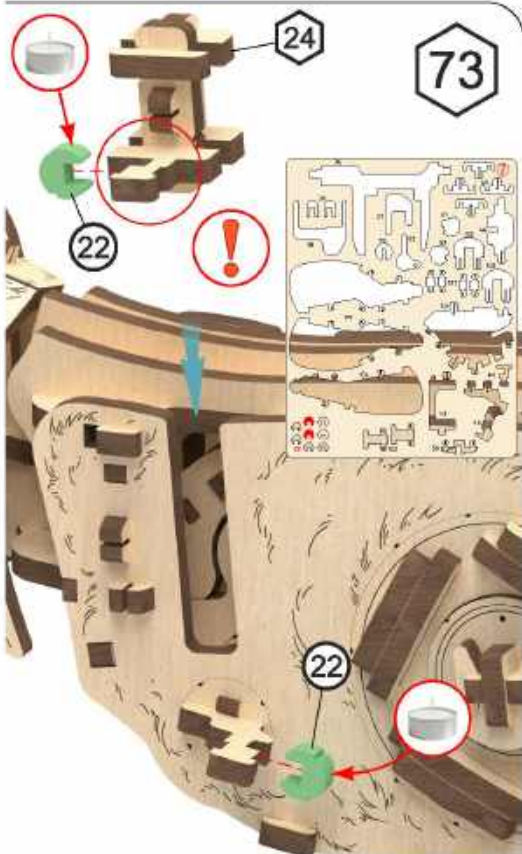
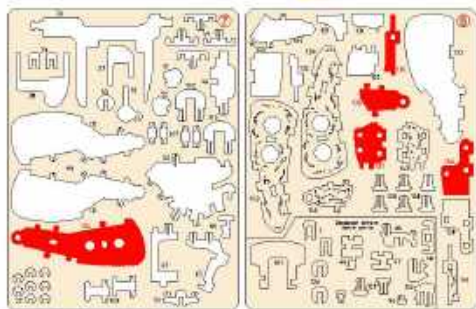
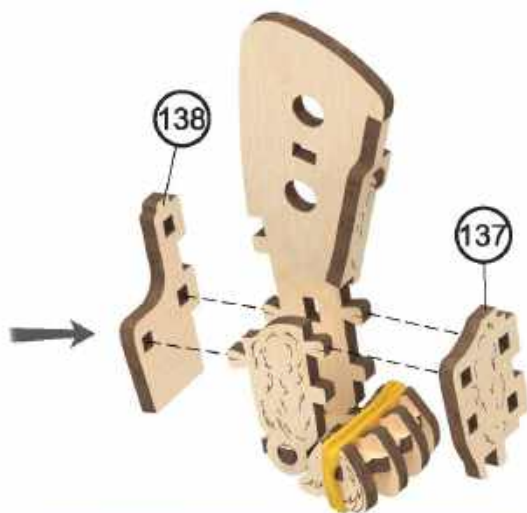
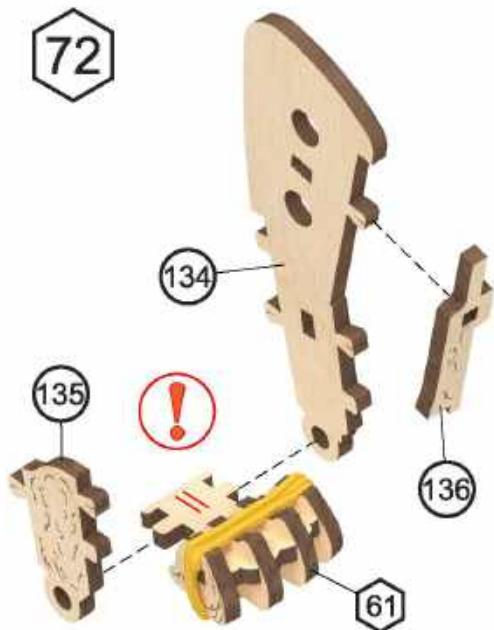

73

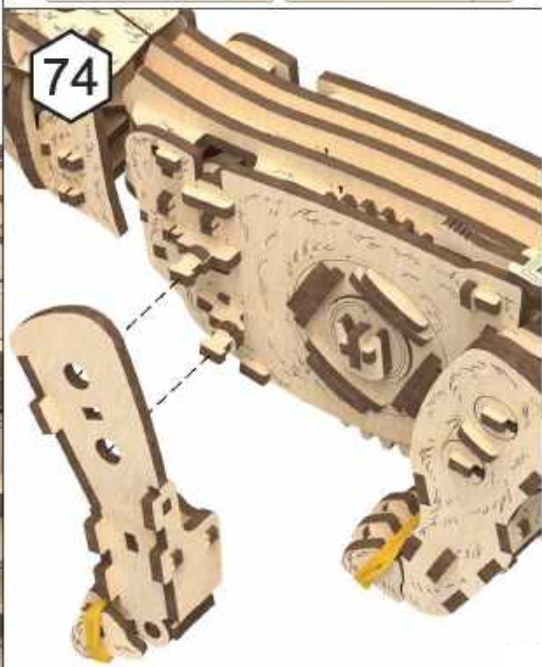

74

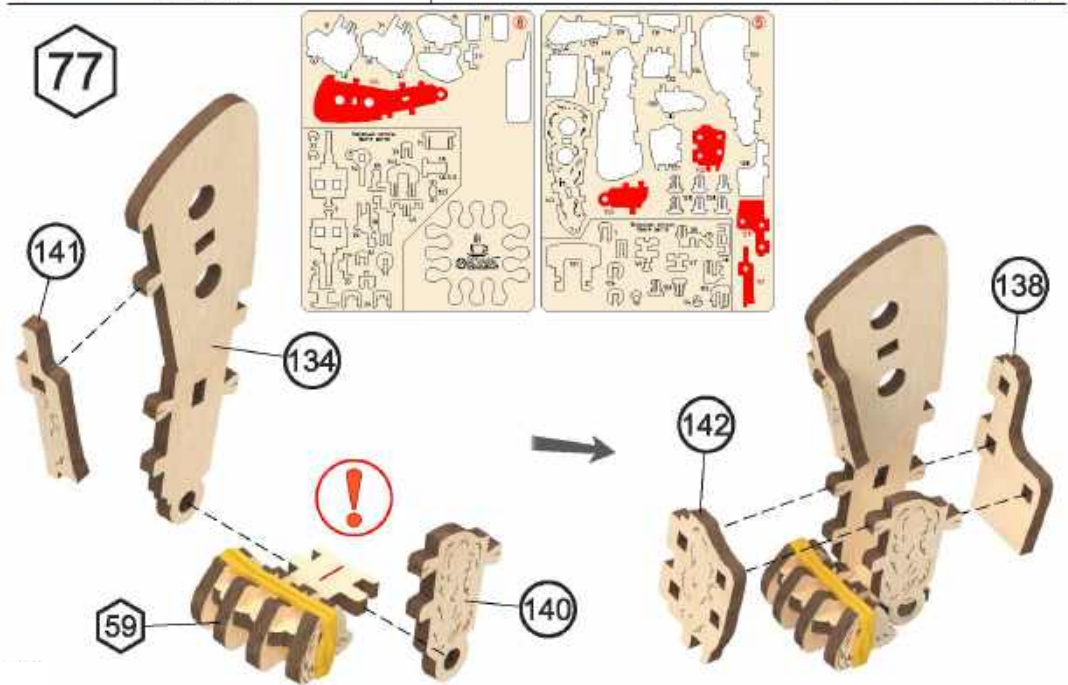
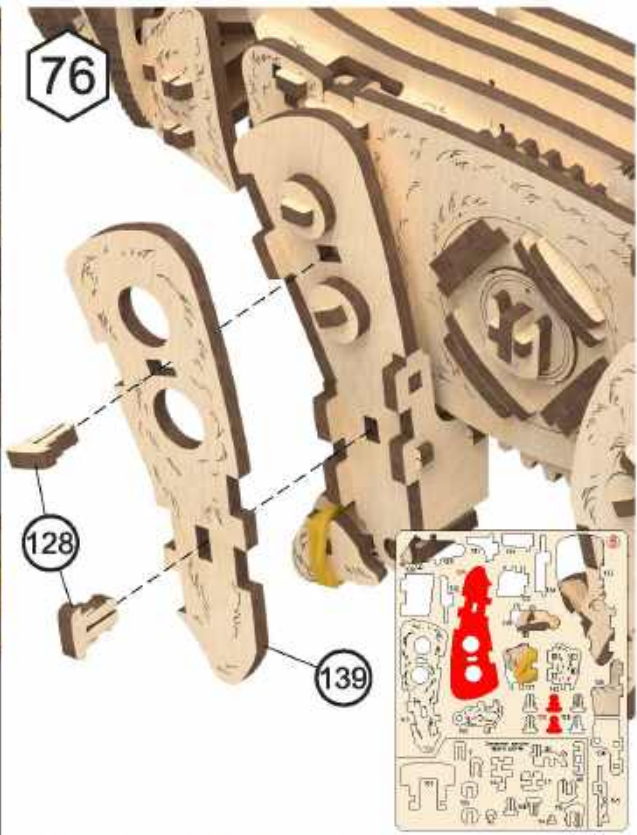
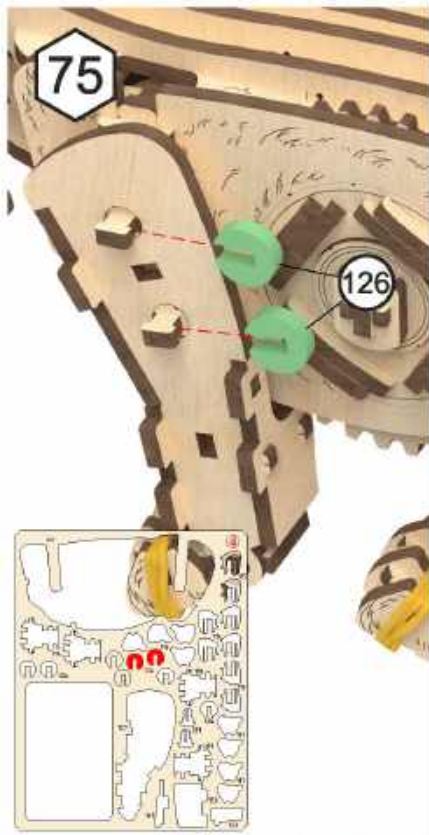

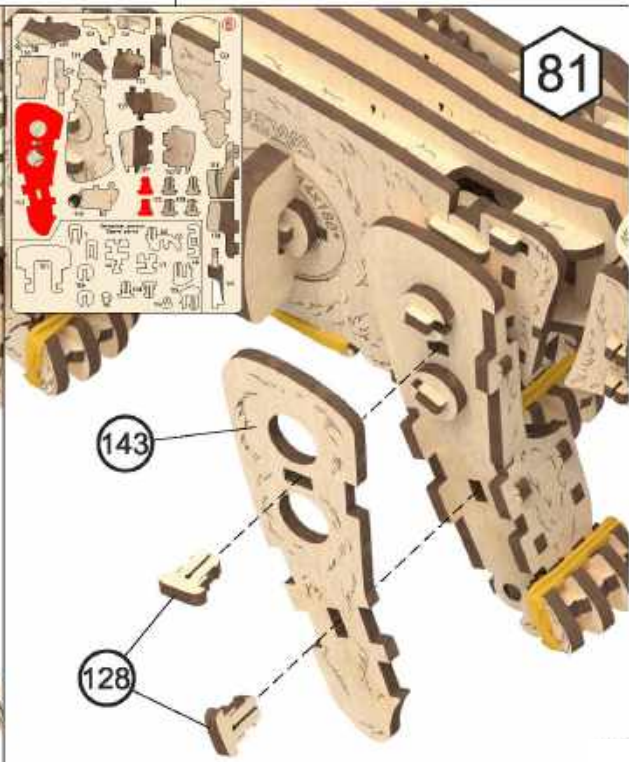
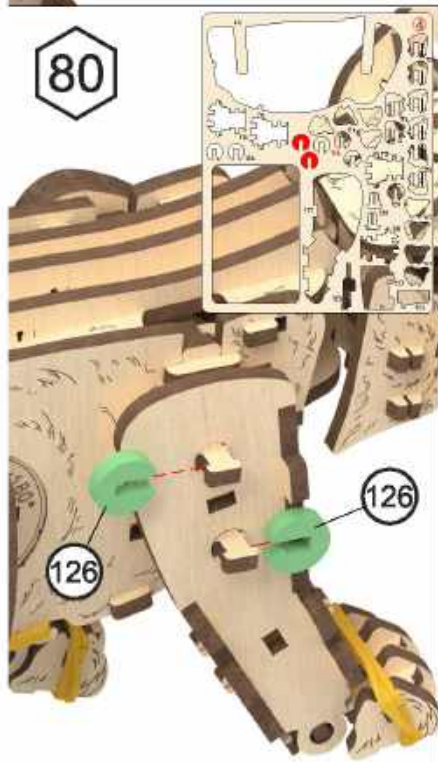
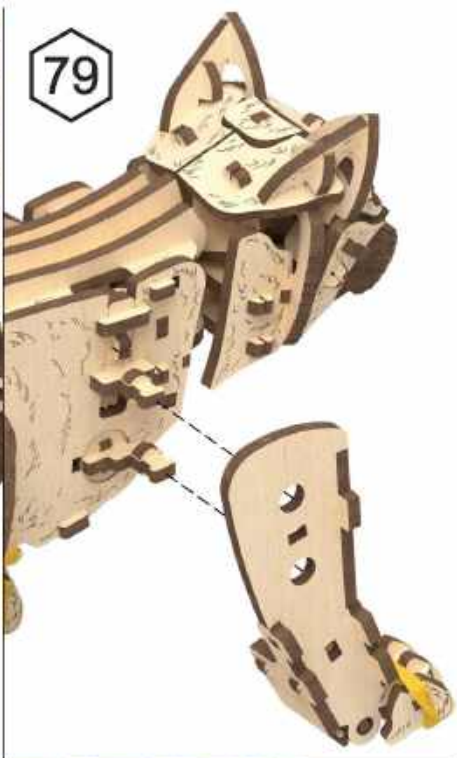
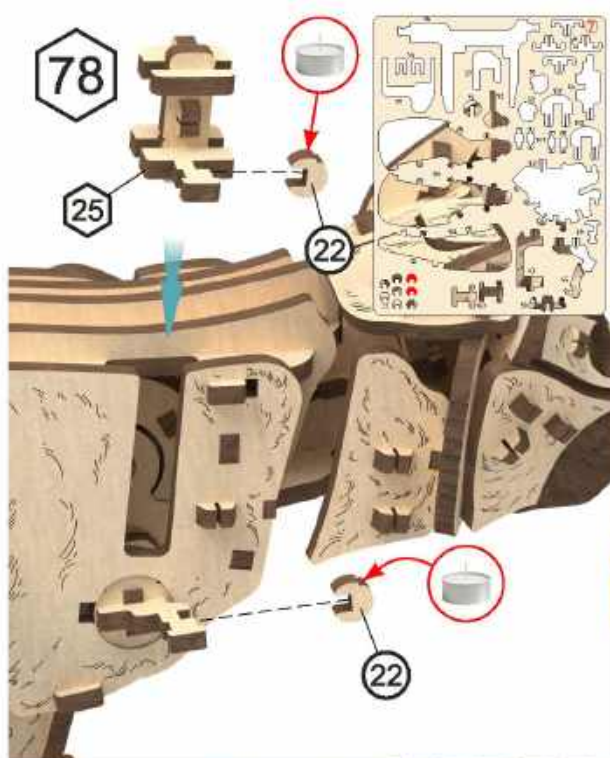

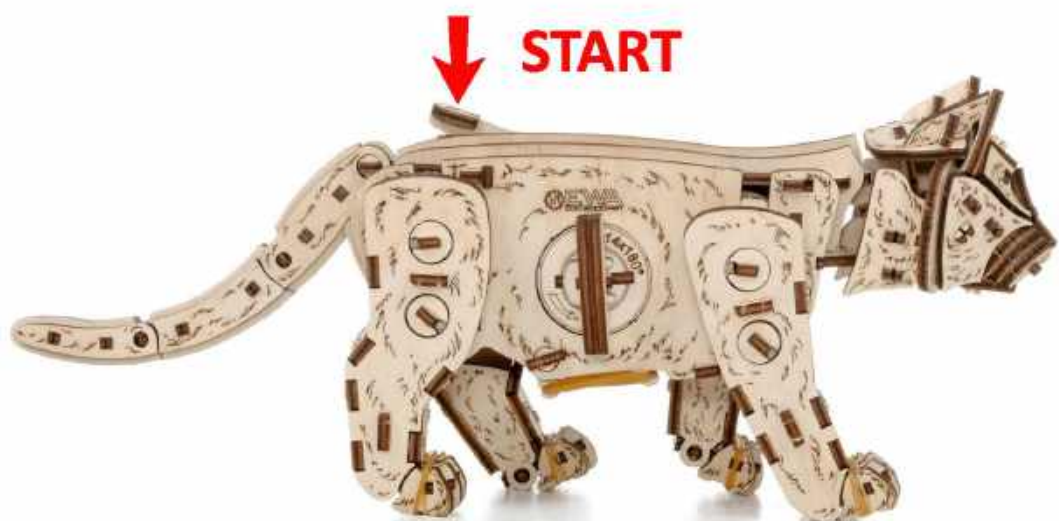
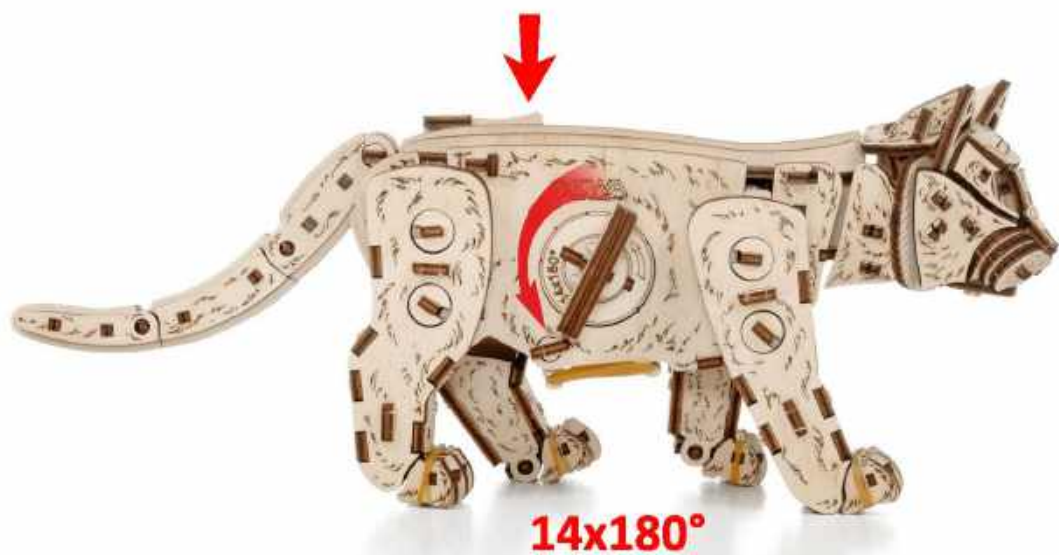

ASSEMBLY INSTRUCTION FOR MODEL



KITTEN



- EN** The ledge is for the squeezing the small details out of the board
PL Występ w linijce przeznaczony jest do wyciskania małych detali z arkusza sklejki
FR La proéminence est conçue pour aider à presser et enlever les petits détails de la feuille
ES La repisa es para apretar los pequeños detalles fuera del tablero
DE Der Vorsprung dient dazu, kleine Teile aus den Platten zu drücken
RU Выступ предназначен для выдавливания из листа мелких деталей
IT Le proiezioni riportate sui fogli di istruzione sono utili anche nella fase di smontaggio per estrarre i pezzi
CN 輔助測量尺可幫助取出或緊接細小零件時使用
CZ Použijte k vytlačení malých částí z desky

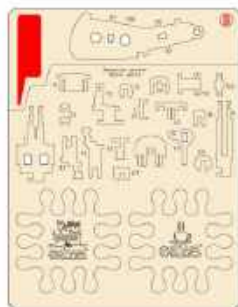

- EN** Remove the burrs with sandpaper
PL Usunąć zadziory papierem ściernym
FR Retirer les bavures avec du papier à polir
ES Quitar las rebabas con el papel esmeril
DE Grate mit Schleifpapier entfernen
RU Удалить заусенцы наждачной бумагой
IT Sbavare con carta vetrata
CN 用砂纸去除毛刺。
CZ Vyhlaďte smirkových papírem



- EN** Details should rotate freely
PL Swobodne obracanie
FR Libre rotation
ES Rotación libre
DE Auf freie Rotation achten
RU Свободное вращение
IT Rotazione libera
CN 濃暢地旋轉
CZ Části by se měly volně otáčet



- EN** Wax it with a candle
PL Posmaruj za pomocą świecy parafinowej
FR Graisser avec une bougie de paraffine
ES Engrasar con ayuda de una vela de parafina
DE Mit einer Kerze wachsen
RU Смазать парафиновой свечой
IT Lubrificare con candela di paraffina
CN 用干蜡烛上蜡润滑
CZ Navoskujte svíčkou



- EN** Pay attention
PL Uwaga
FR Faire attention
ES Prestar atención
DE Achtung
RU Уделить внимание
IT Prestare attenzione
CN 请注意
CZ Pozor

EN The manufacturer reserves the right to make changes in the design of the product, not worsening its technical characteristics. Information about the changes made may not be present in this manual.

PL Producent zastrzega sobie prawo do zmiany konstrukcji wyrobu bez pogorszenia jego właściwości technicznych. Niniejsza instrukcja może nie zawierać informacji o zmianach.

FR Le producteur se réserve le droit d'apporter des modifications dans la construction du produit à condition si elles ne portent atteinte à ses caractéristiques techniques. Les renseignements sur les modifications apportées peuvent ne pas être dans la présente notice.

ES El fabricante se reserva el derecho de introducir modificaciones en la construcción del producto, que no empeoran sus características técnicas. Datos sobre modificaciones introducidas pueden no aparecer en esta instrucción.

DE Der Hersteller behält sich das Recht auf Designänderungen, die die technischen Merkmale und Funktionen nicht negativ beeinflussen, vor.

RU Производитель оставляет за собой право вносить изменения в конструкцию изделия, не ухудшающие его технические характеристики. Сведения о внесенных изменениях могут отсутствовать в настоящей инструкции.

IT Il produttore si riserva il diritto di apportare modifiche al design del prodotto, non peggiorando le sue caratteristiche tecniche. Informazioni sulle modifiche apportate potrebbero non essere presenti in questo manuale.

CN 制造商保留对产品设计更改的权利，一切改良旨在增强产品的技术性能。改良处若未出现在手册中，敬请谅解

CZ Vyrobcе si vyhrazuje právo na takové změny v designu produktu, které nebudou mít za následek zhoršení technických vlastností. Informace o změnách nemusí být v návodu uvedeny.

1



4



3



2



1

2

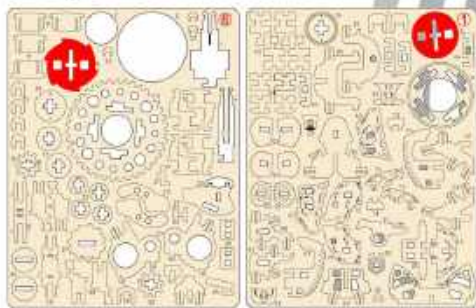

5

6

6

5

3

7

12

12

8

13

14

7

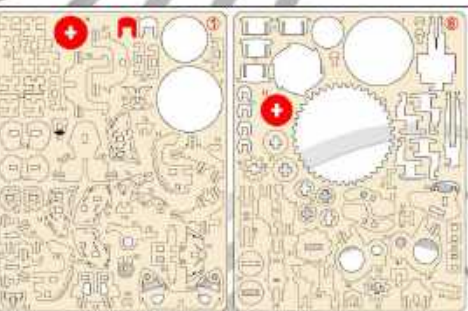

9

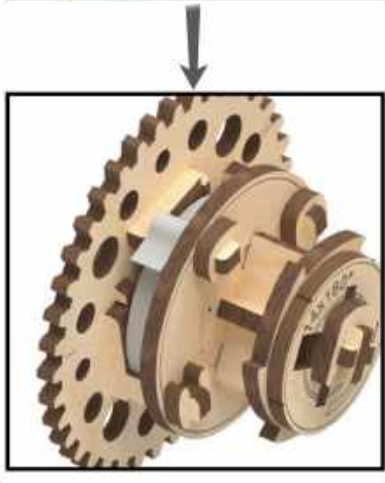

11

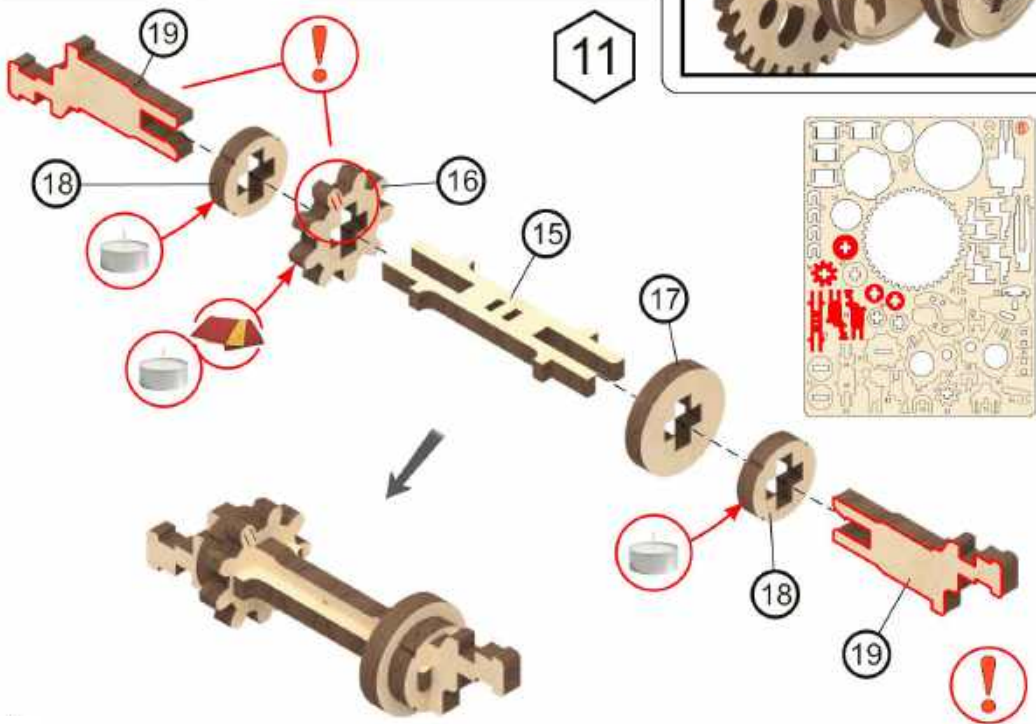

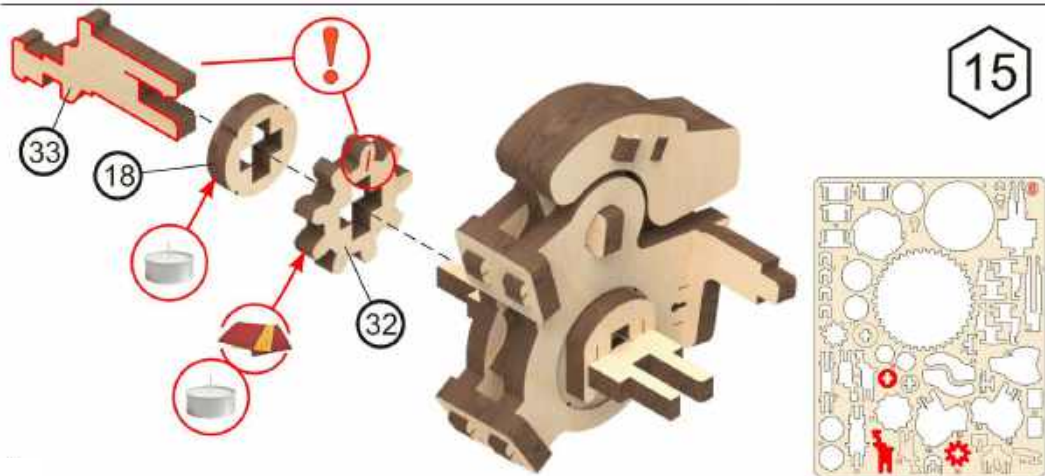
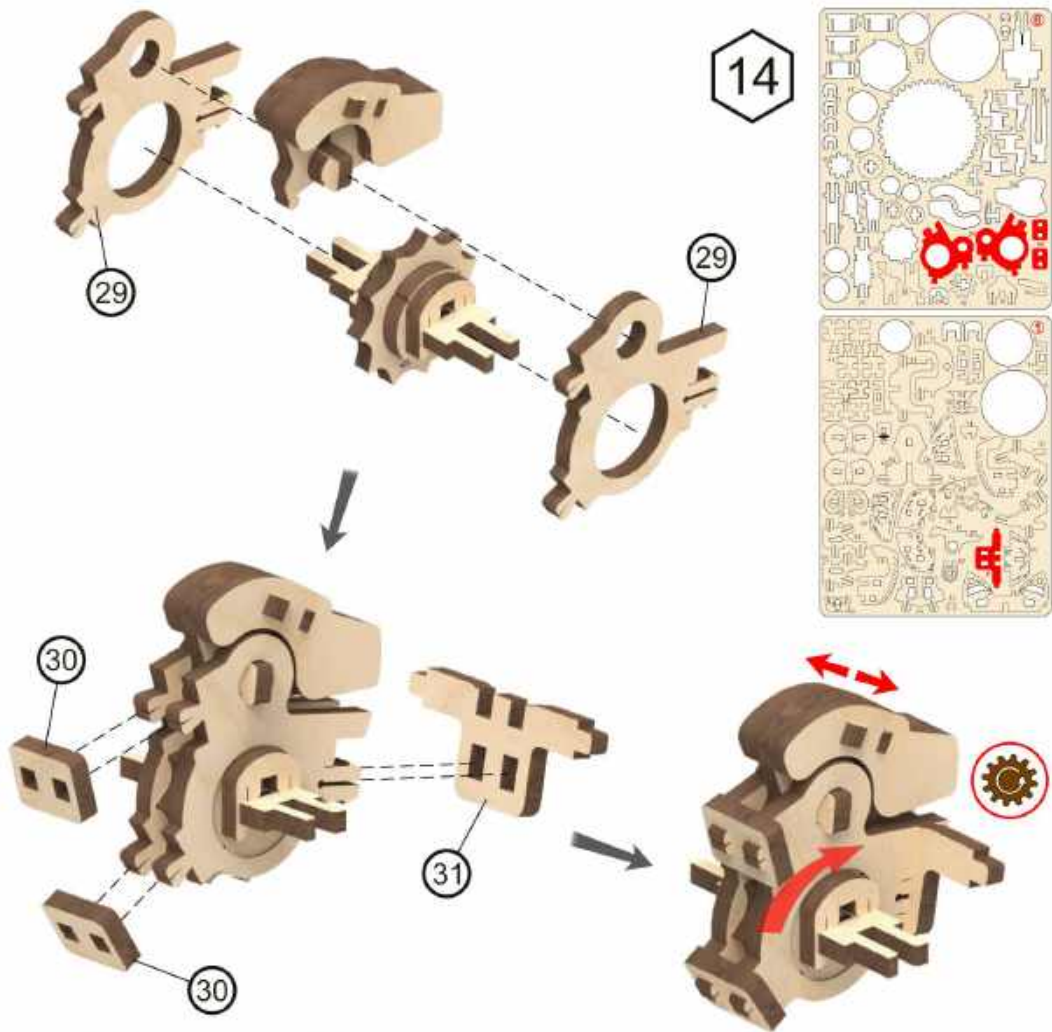

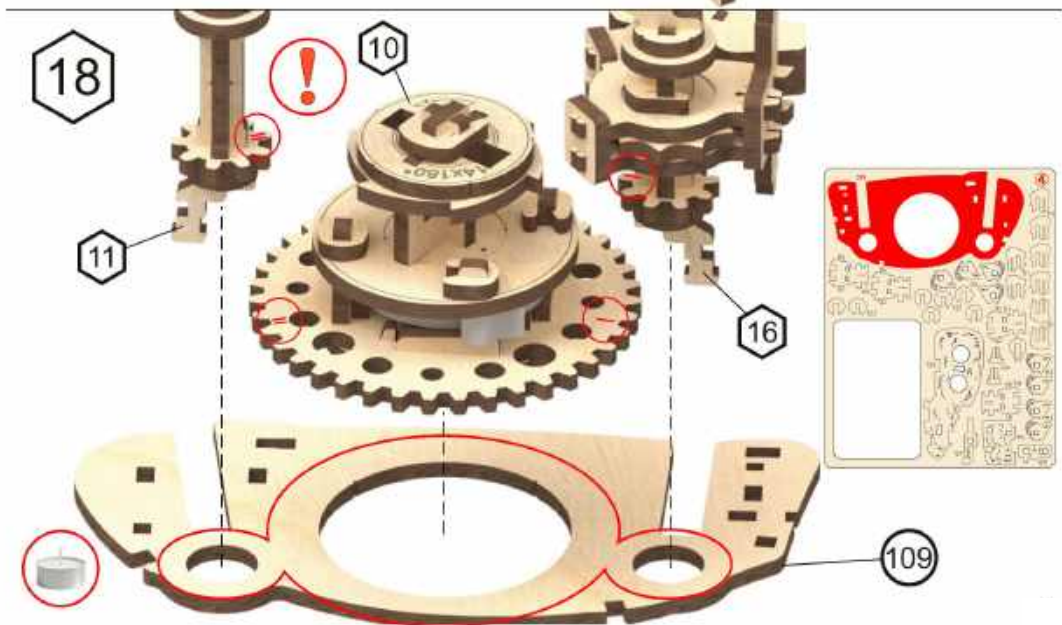
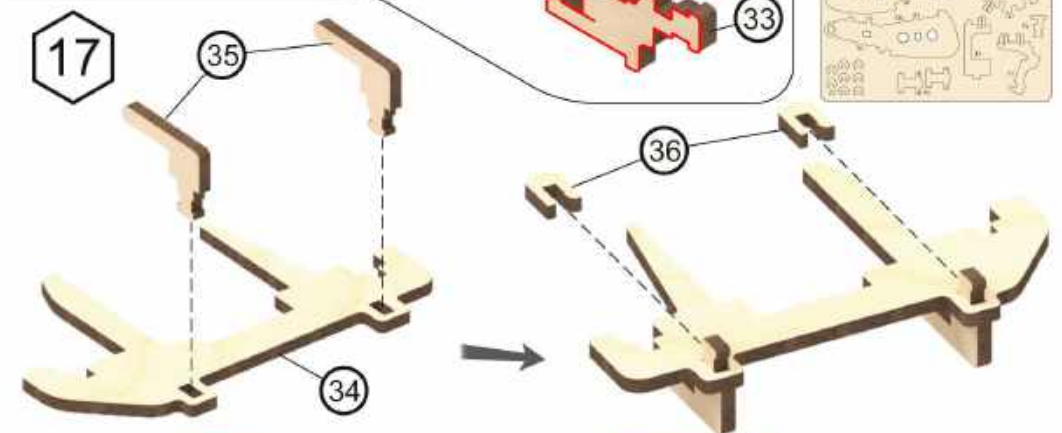
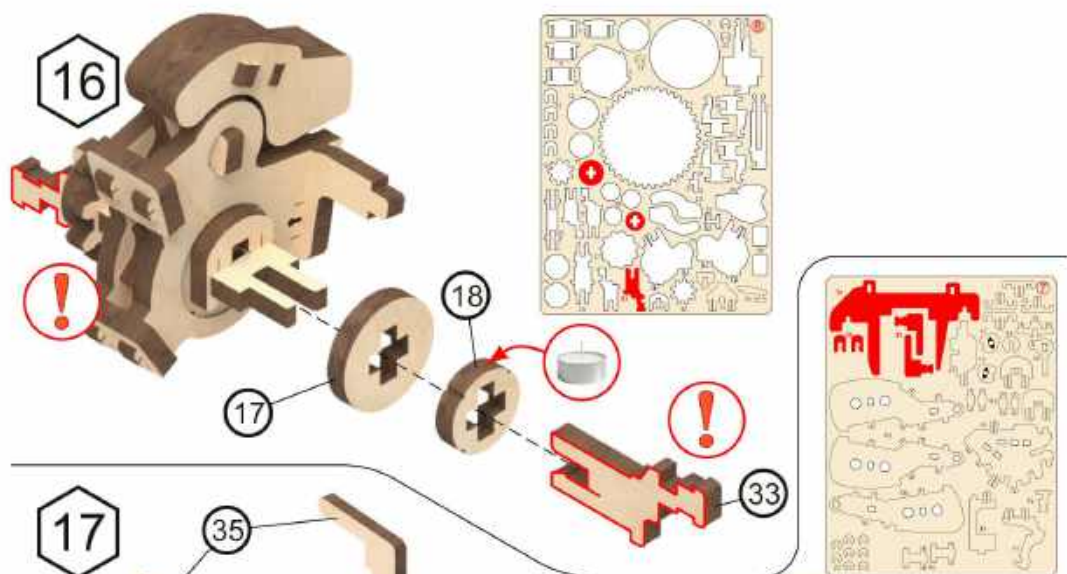

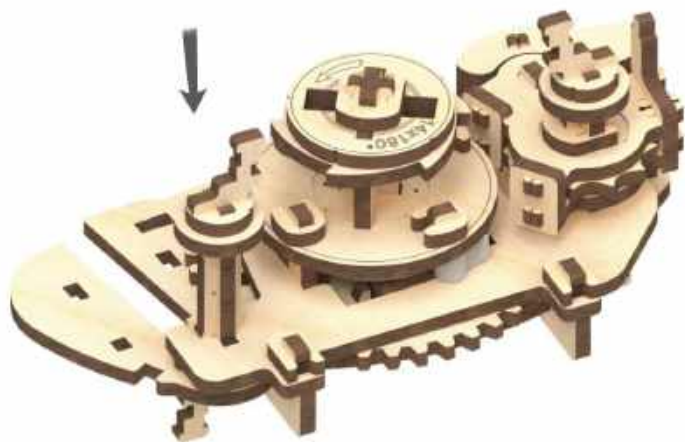
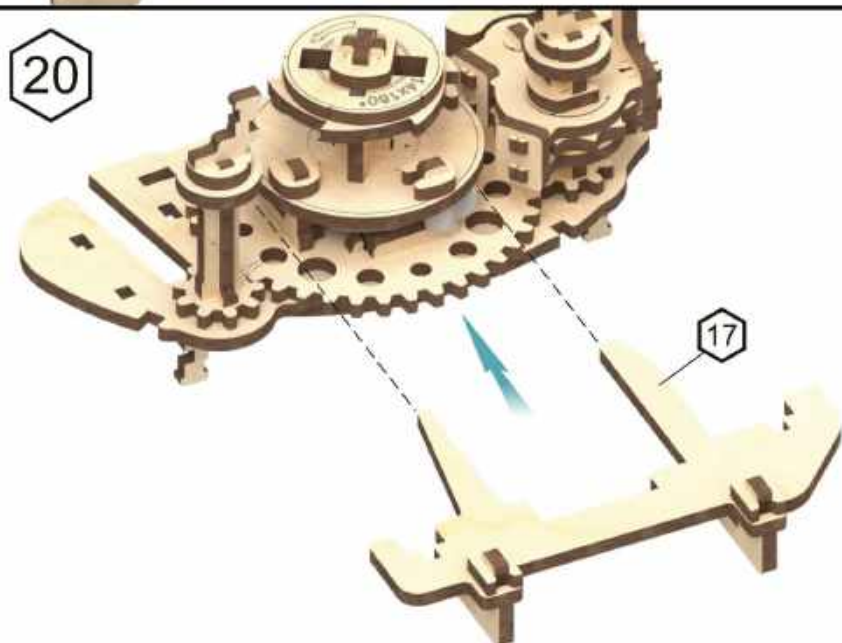
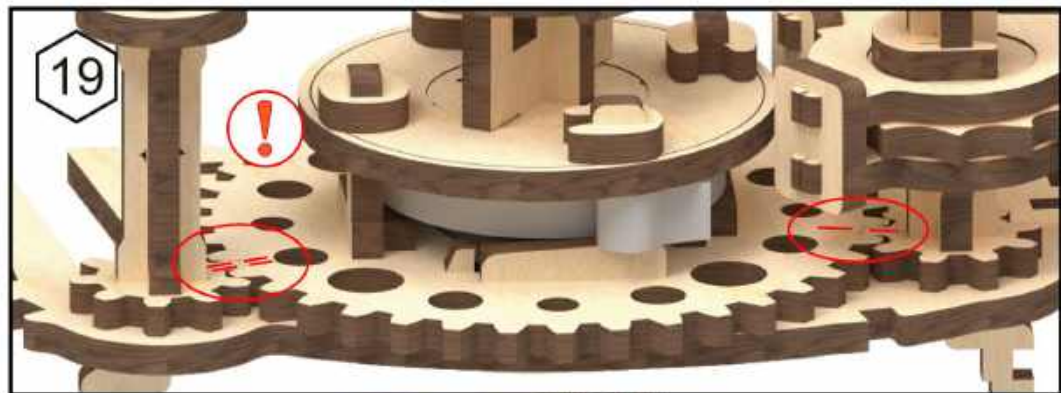

21

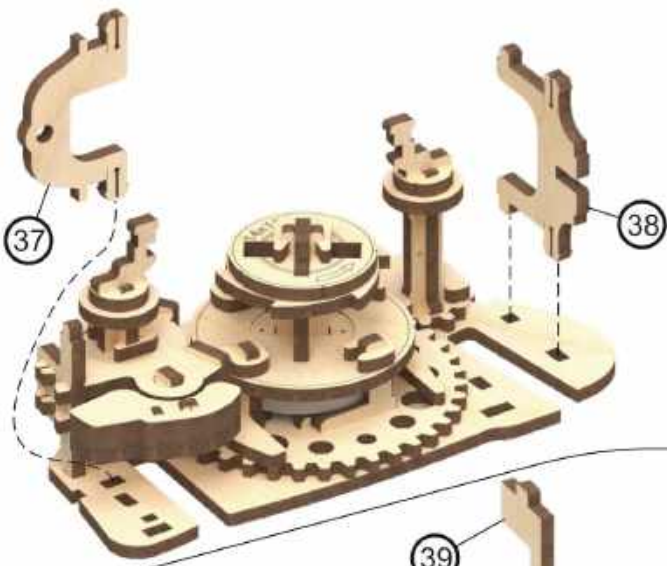

22

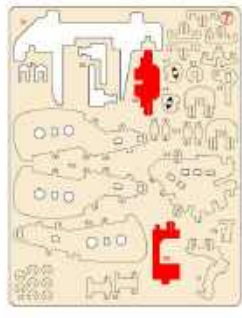
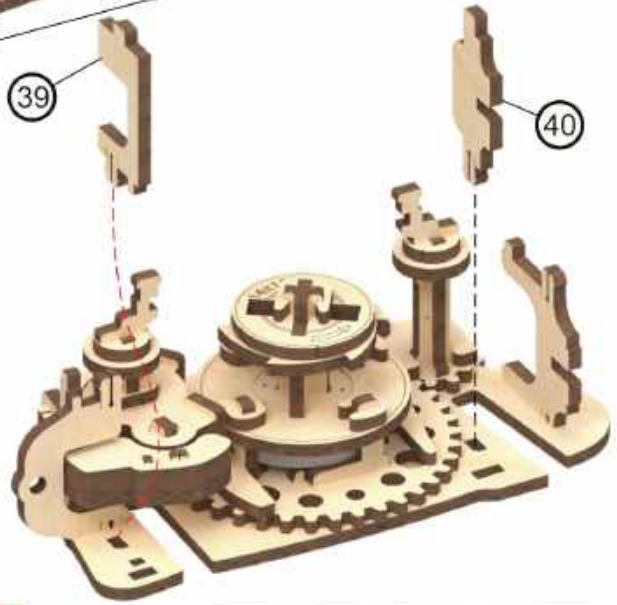

23

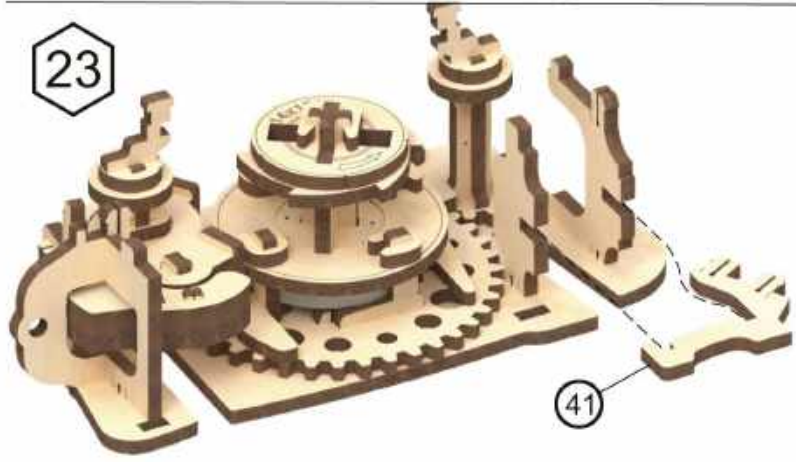

24 x2

43

42

44

45

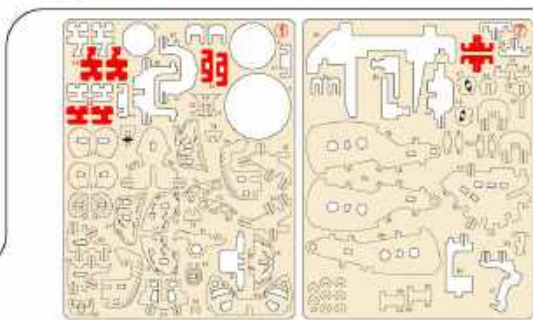
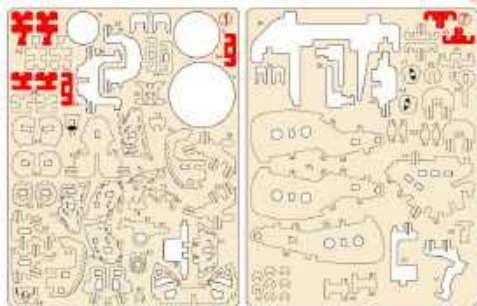

25 x2

43

42

45

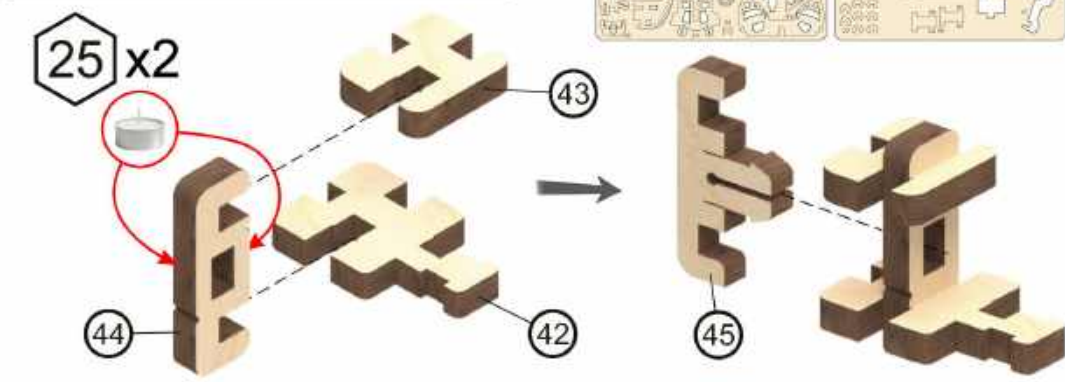

26

25

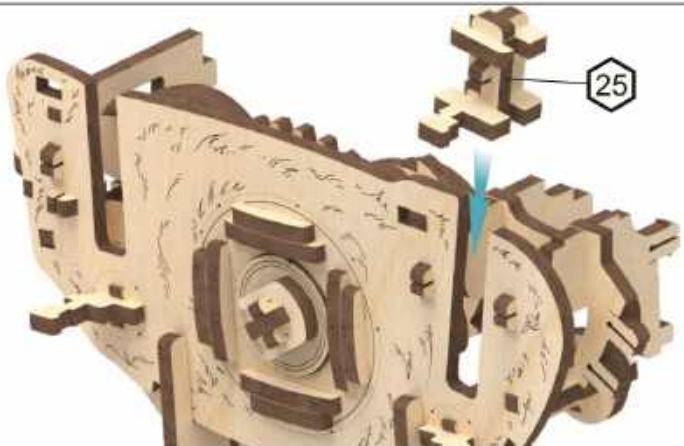

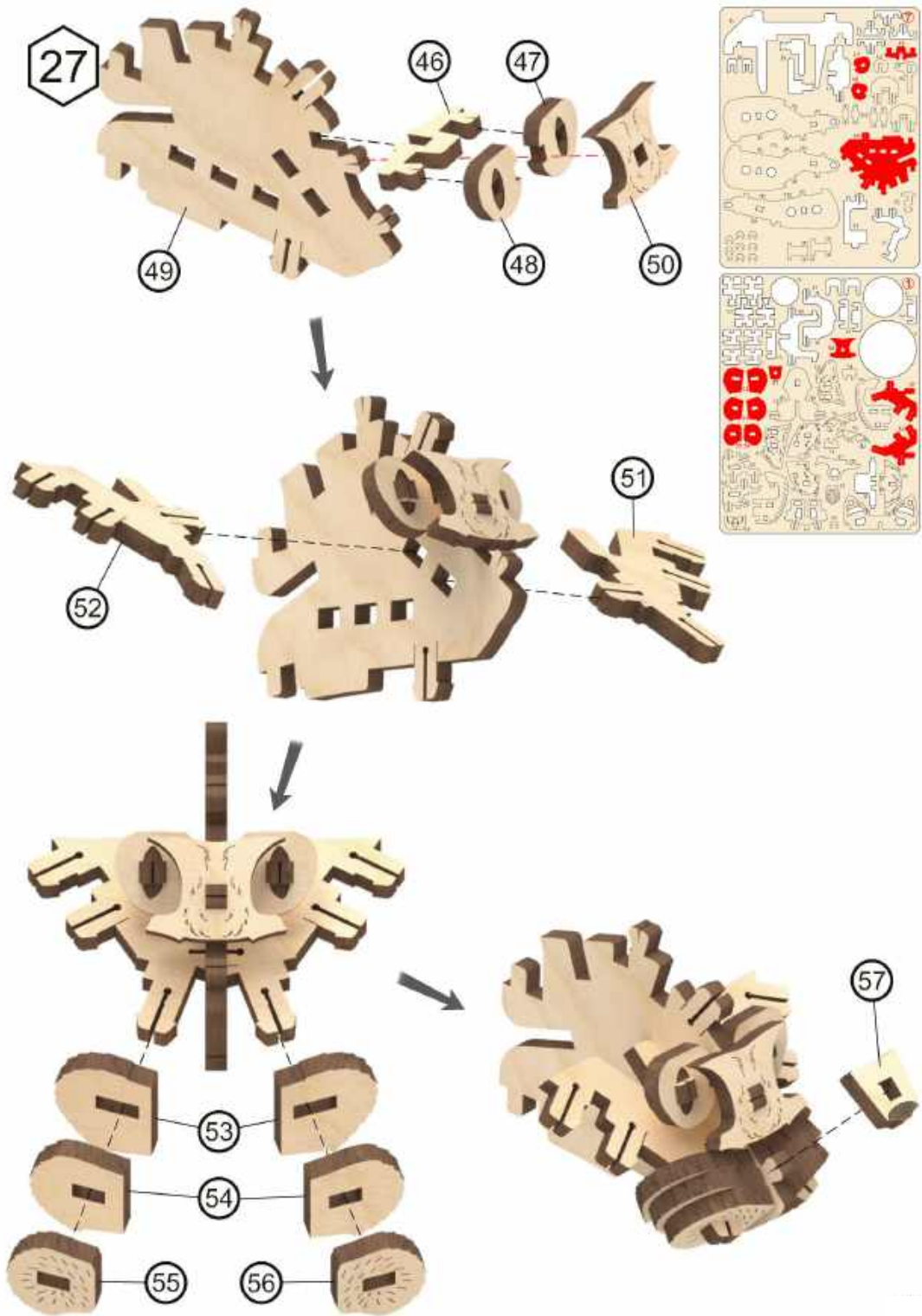

28

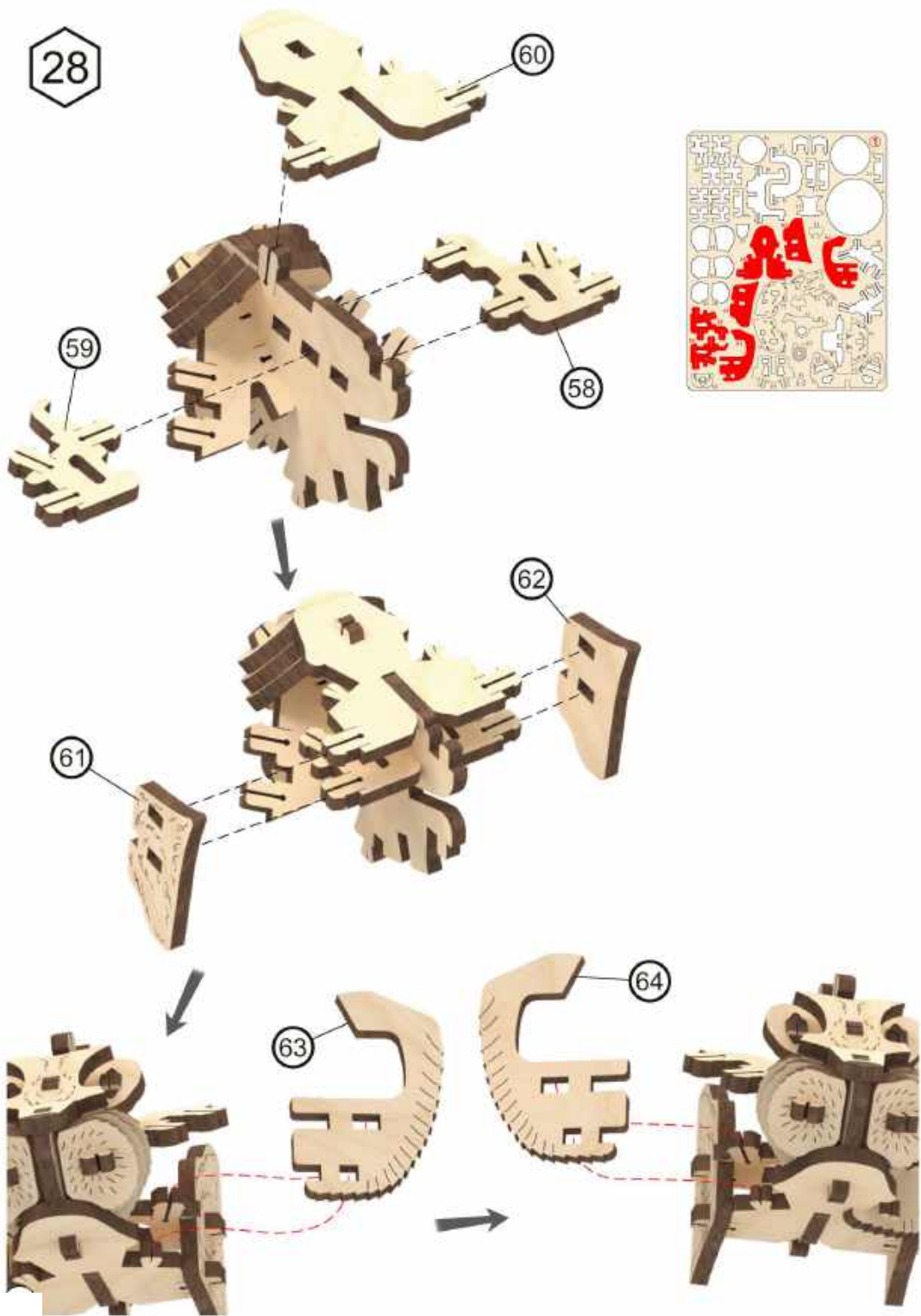

29

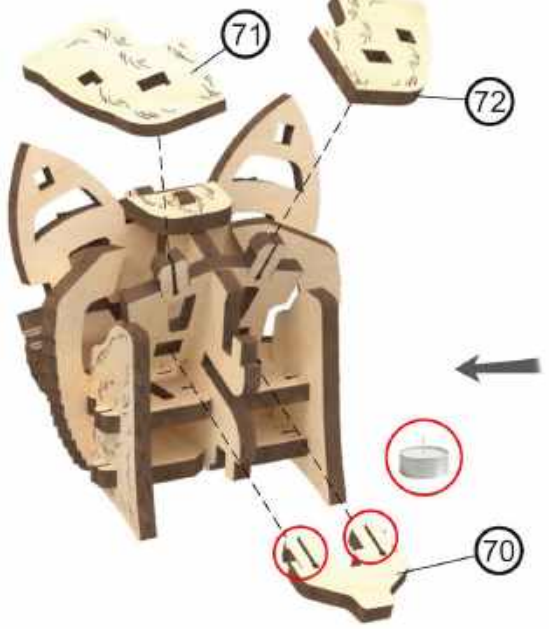
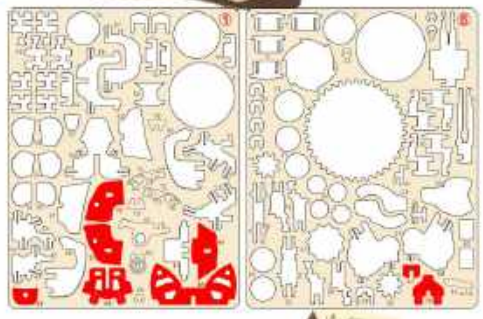
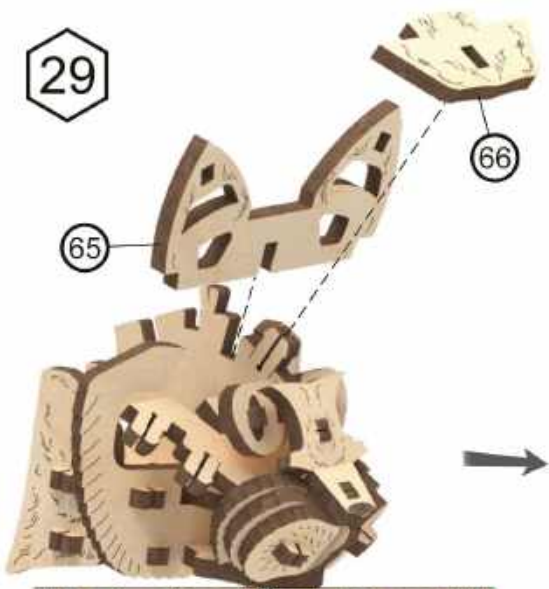

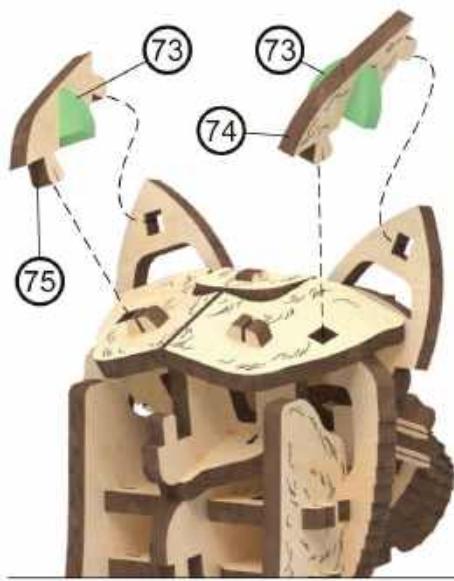

30

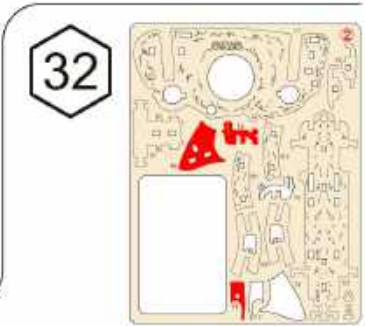

32

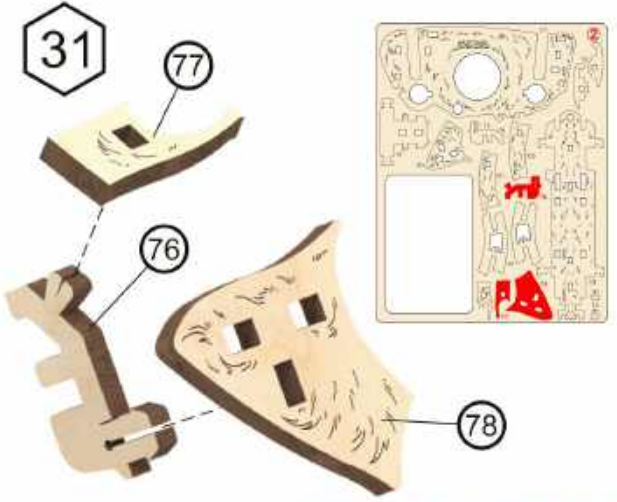

31

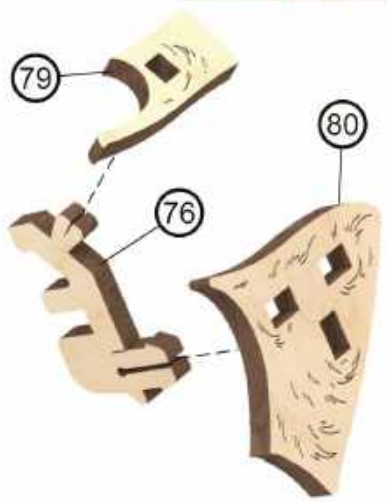
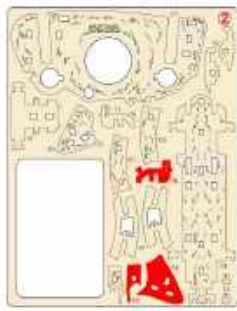

79

80

76

33

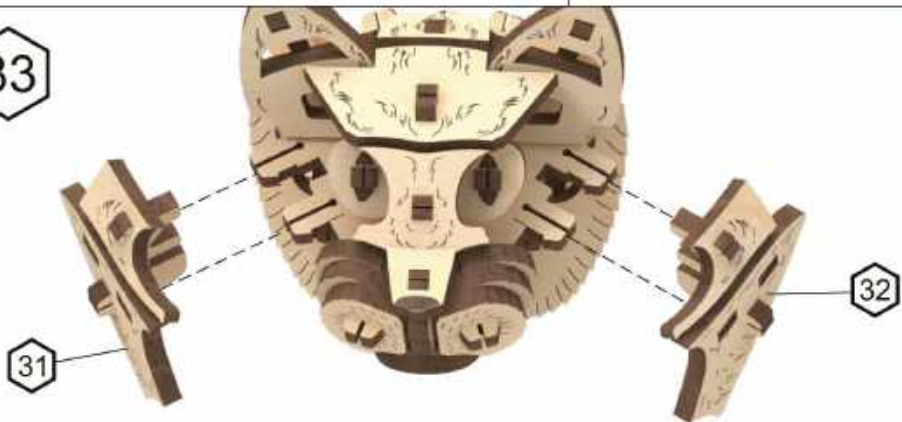

31

32

34

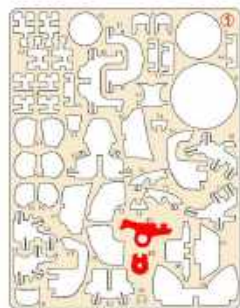

35

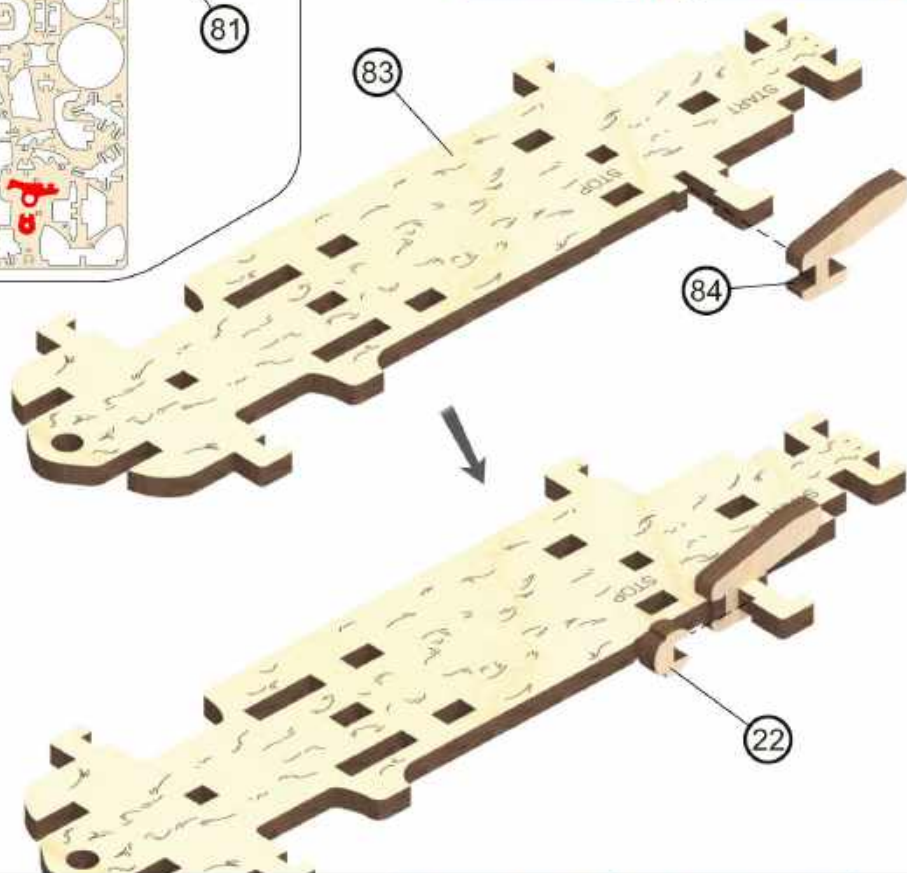
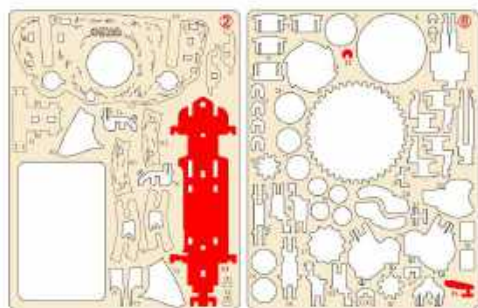

36

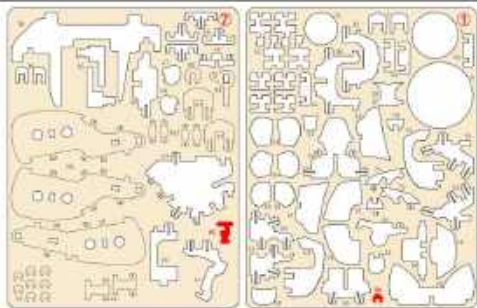
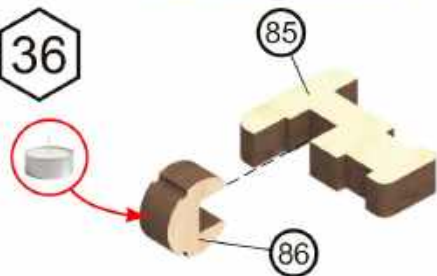

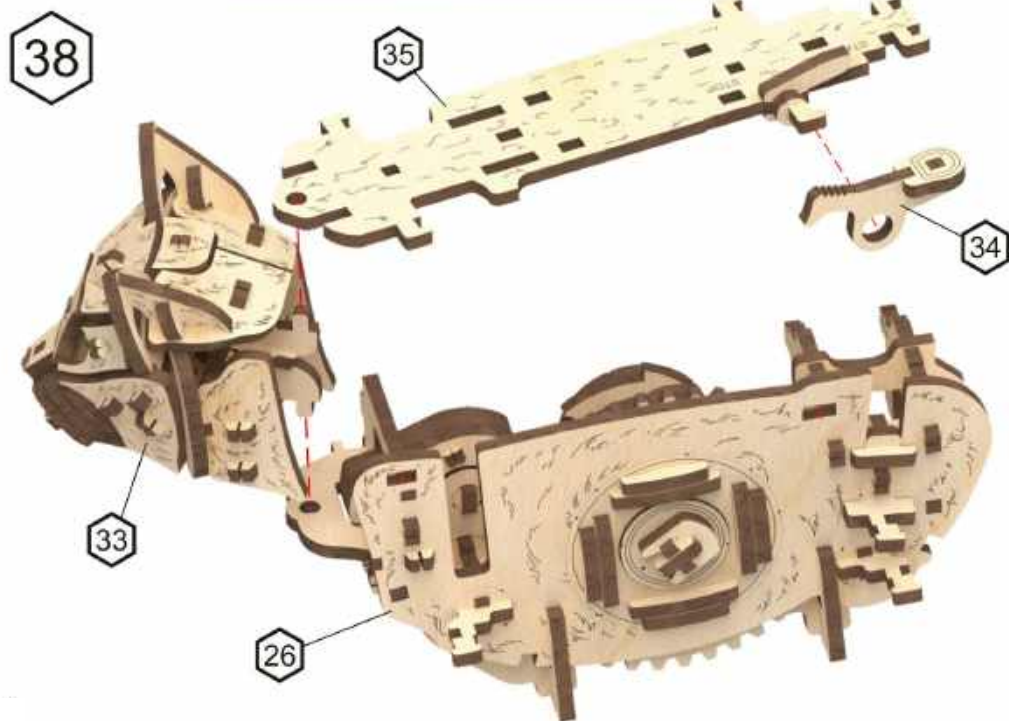
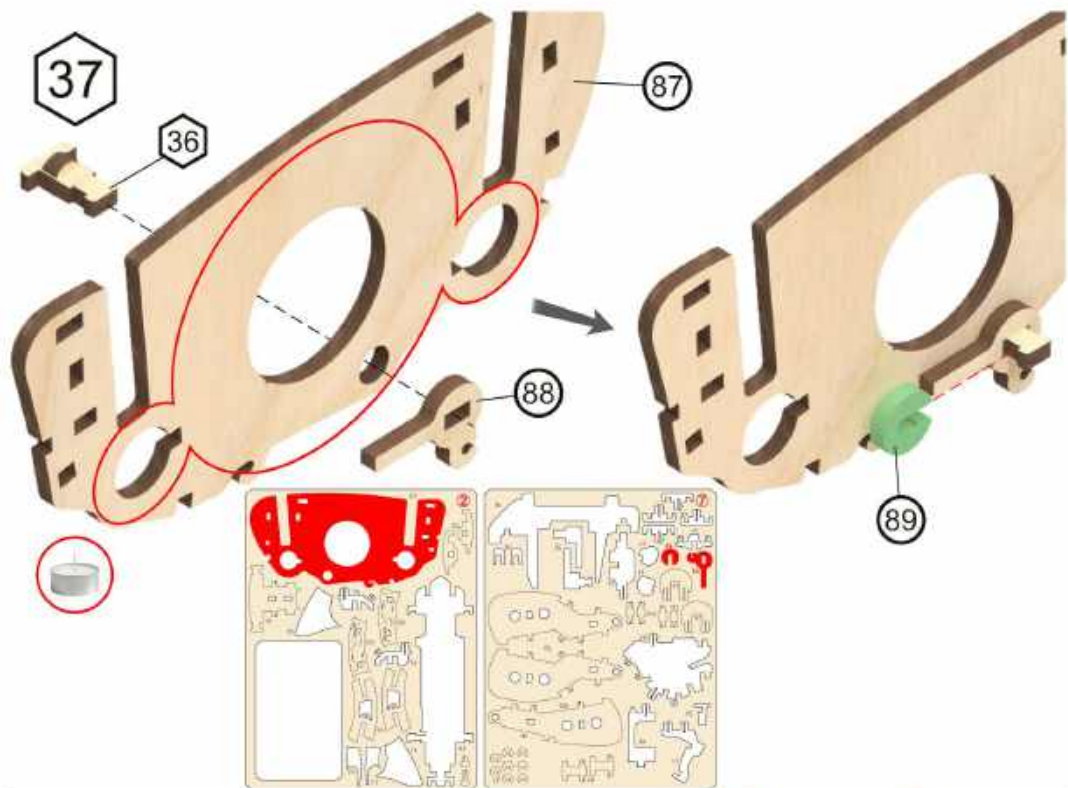

39

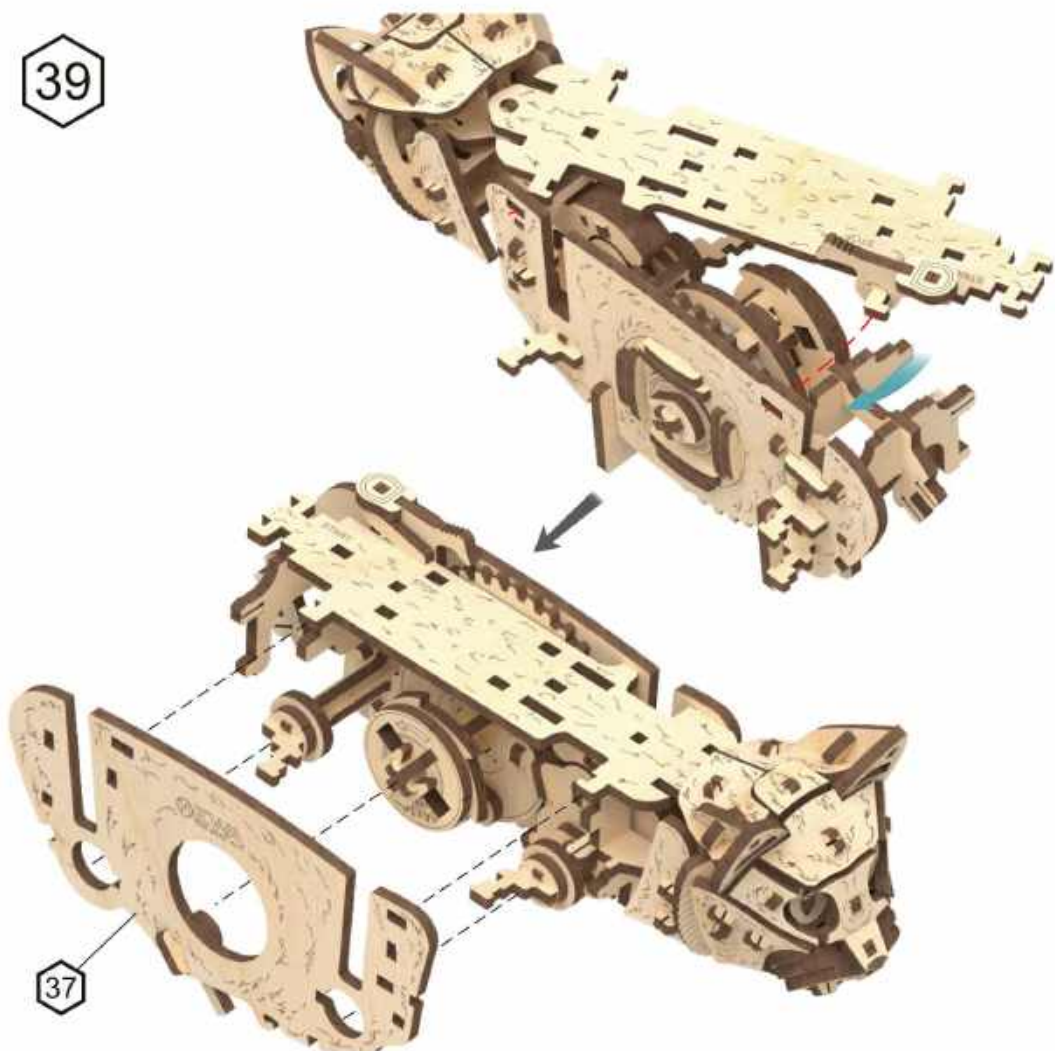

40

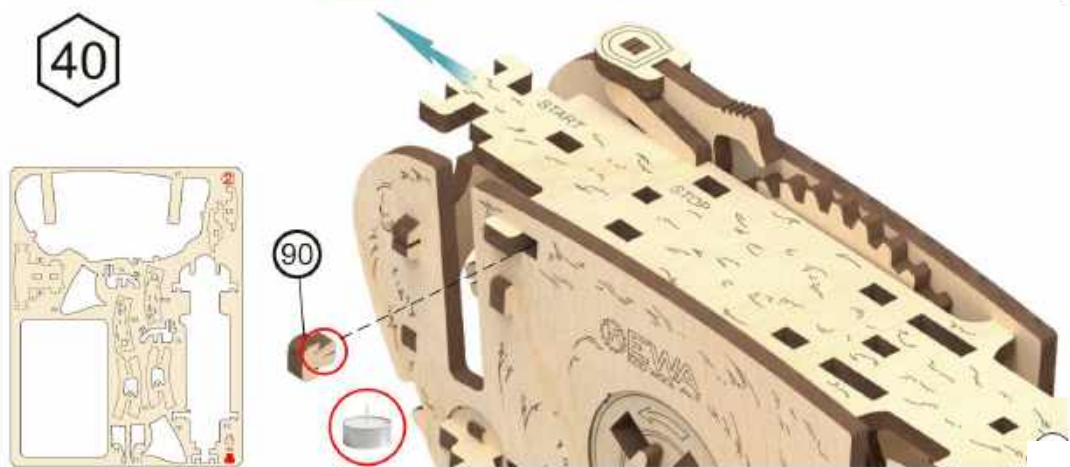

45

94

93



46



95

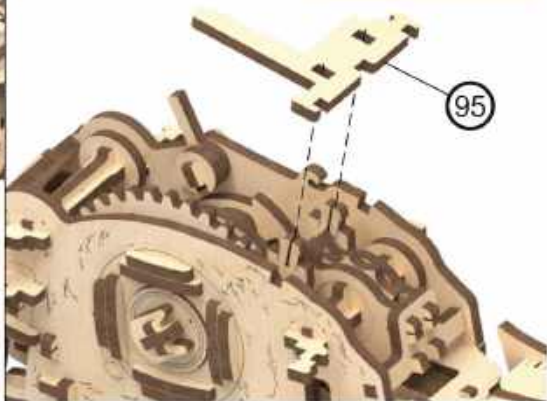

47



48



97

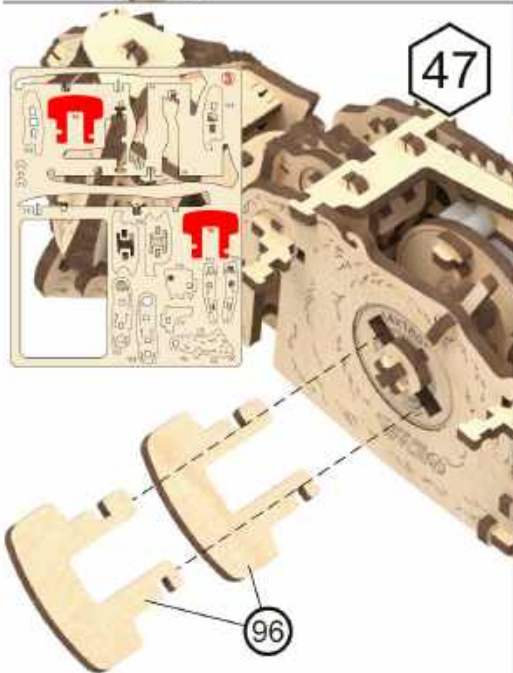

96

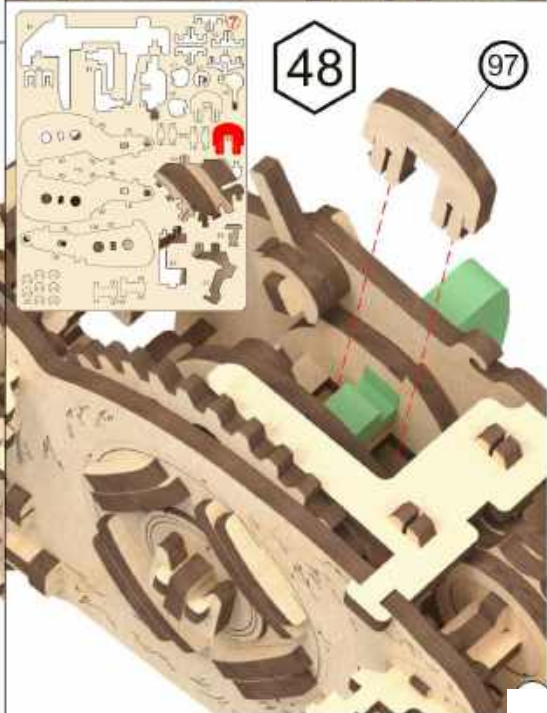

49



50

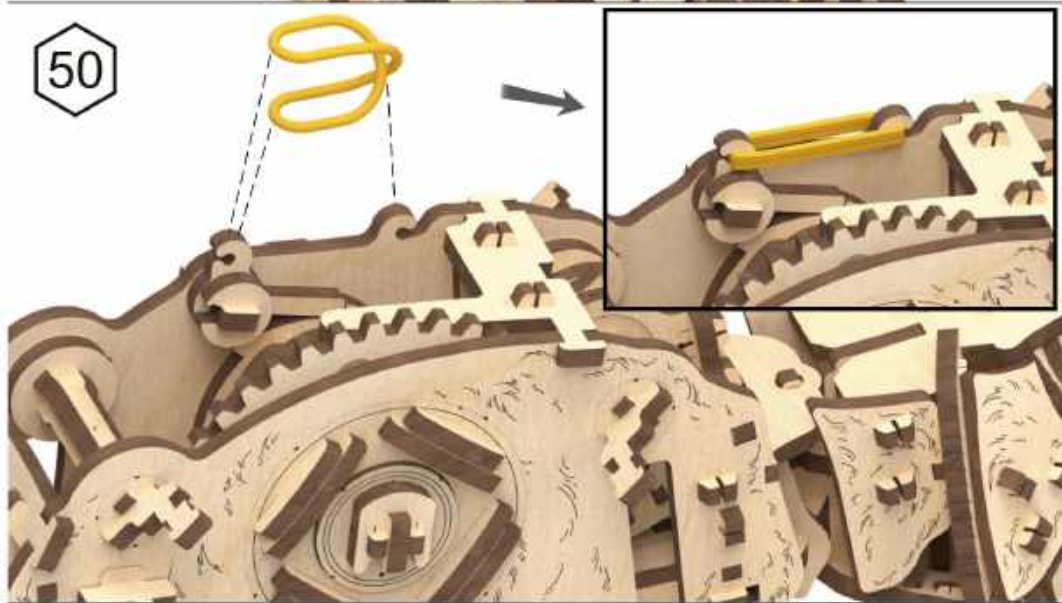

51

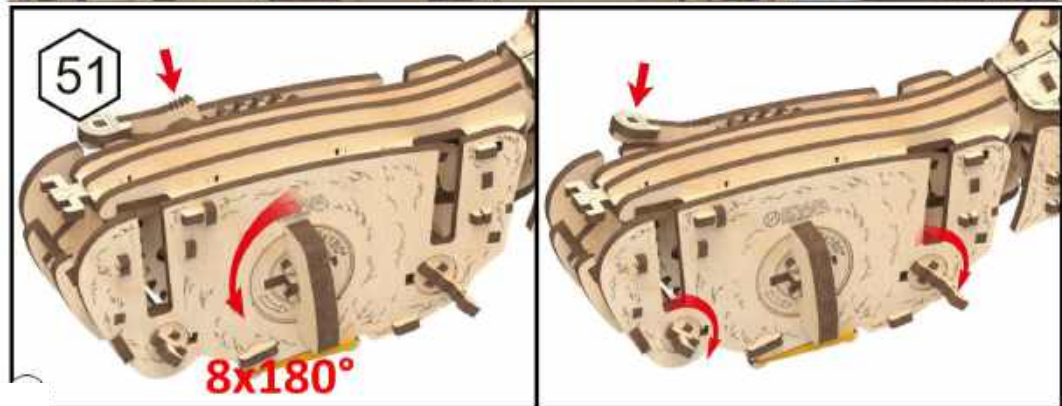

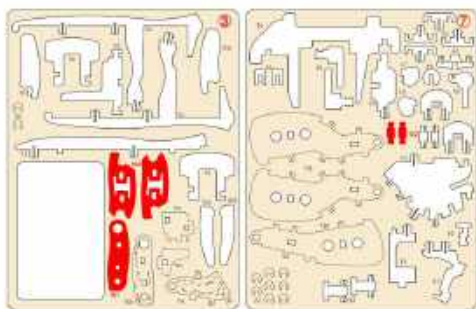
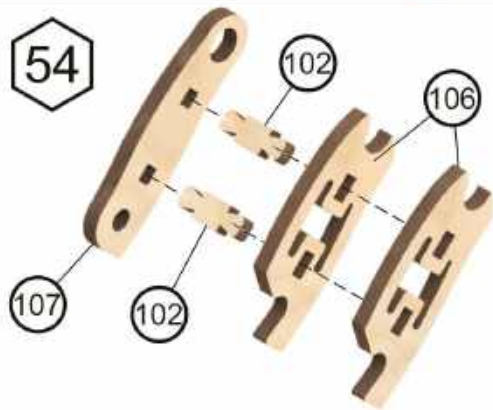
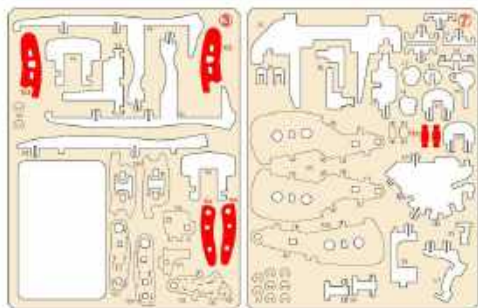
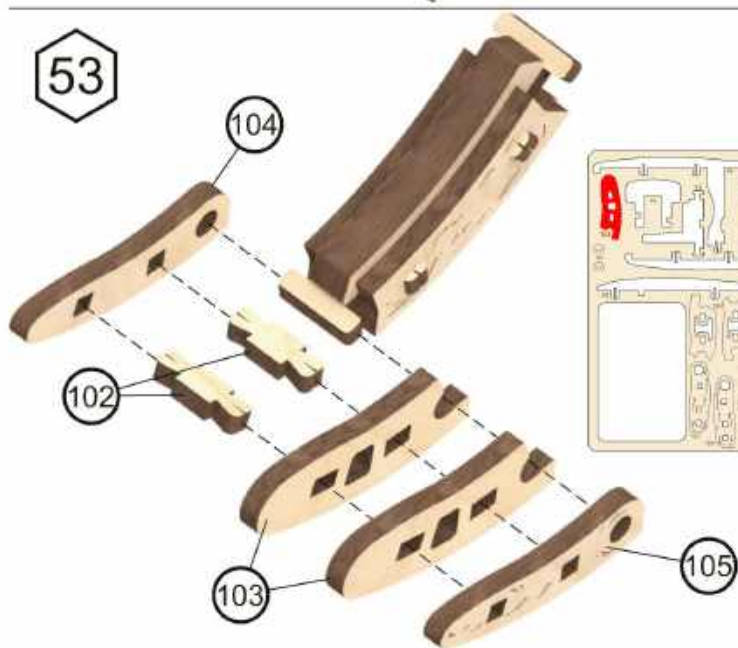
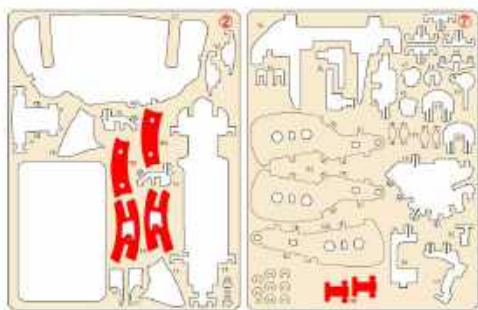
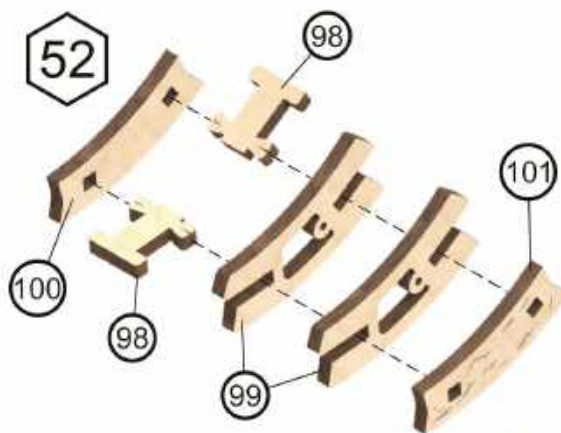

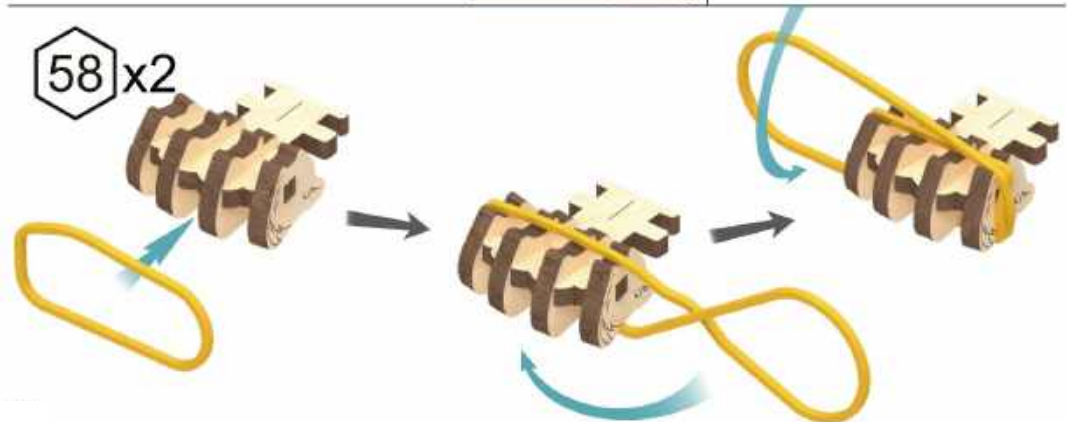
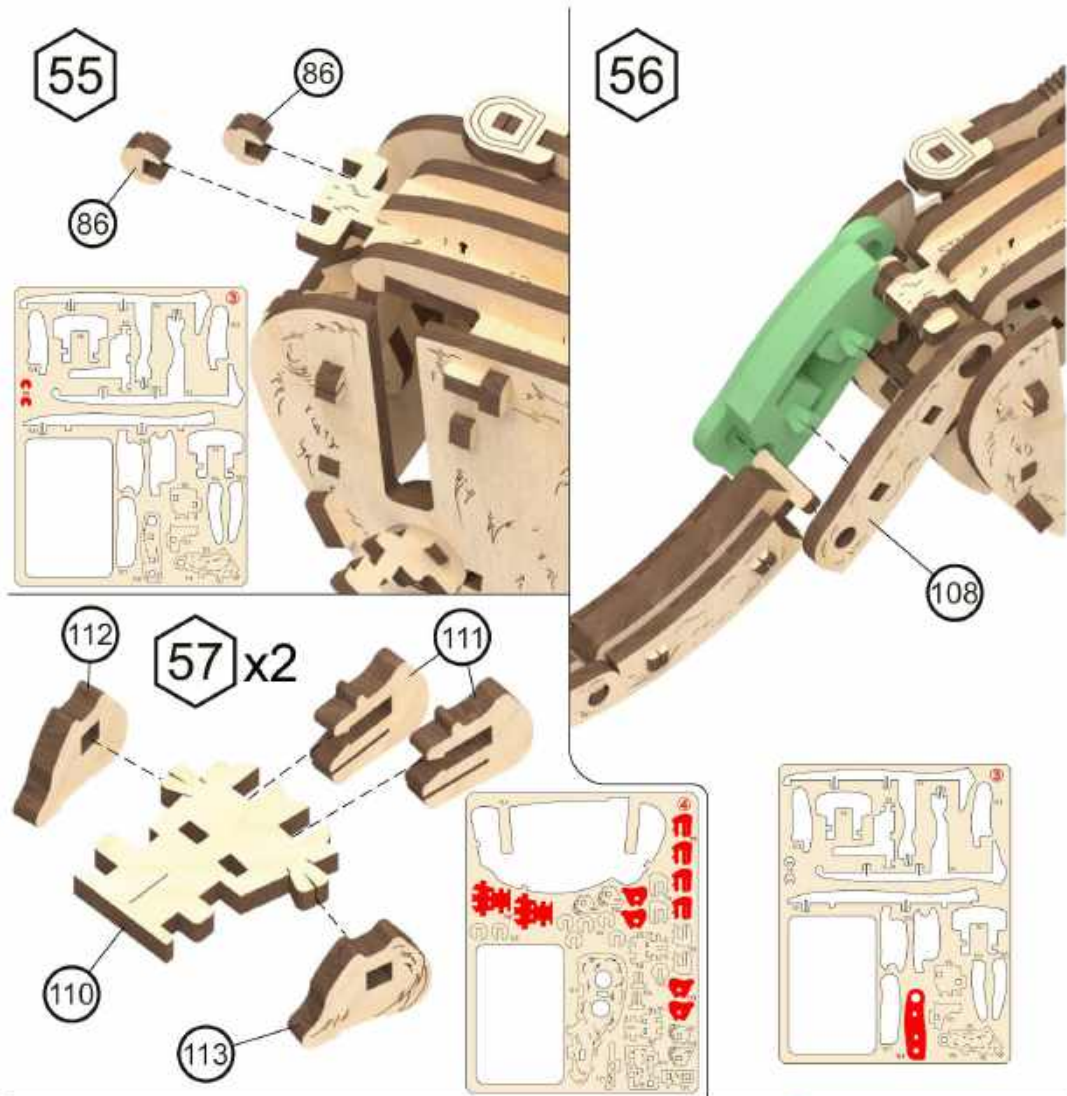

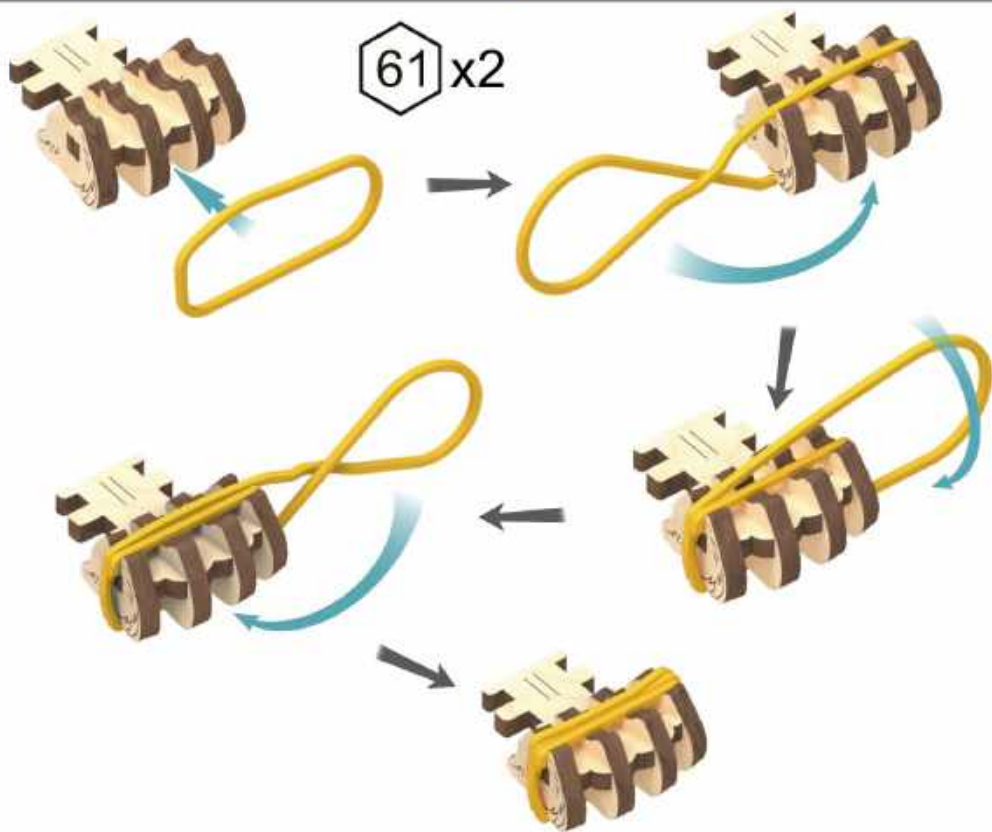
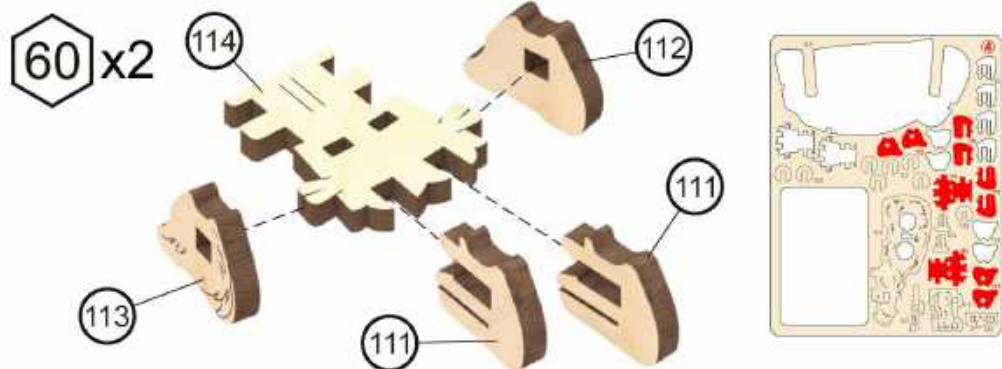
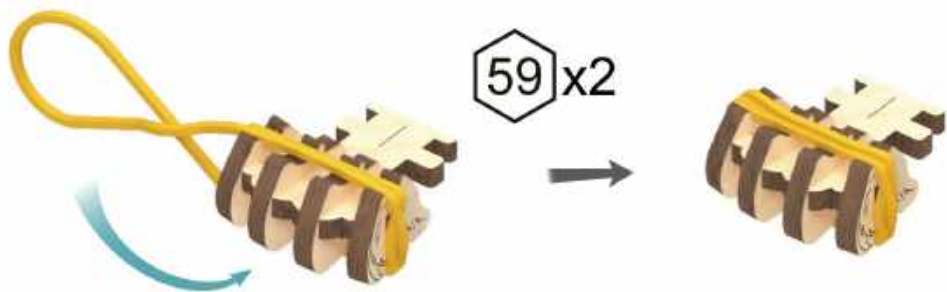

62

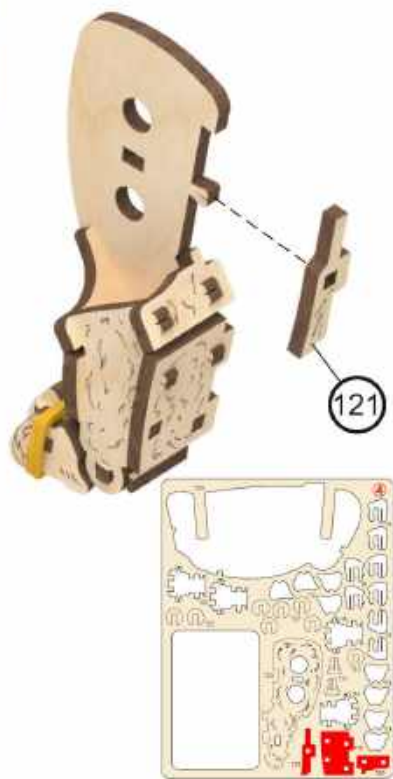
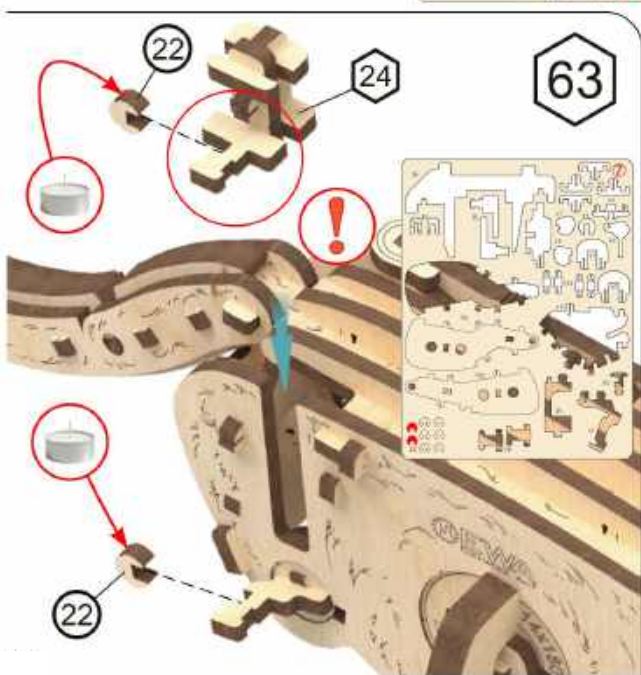
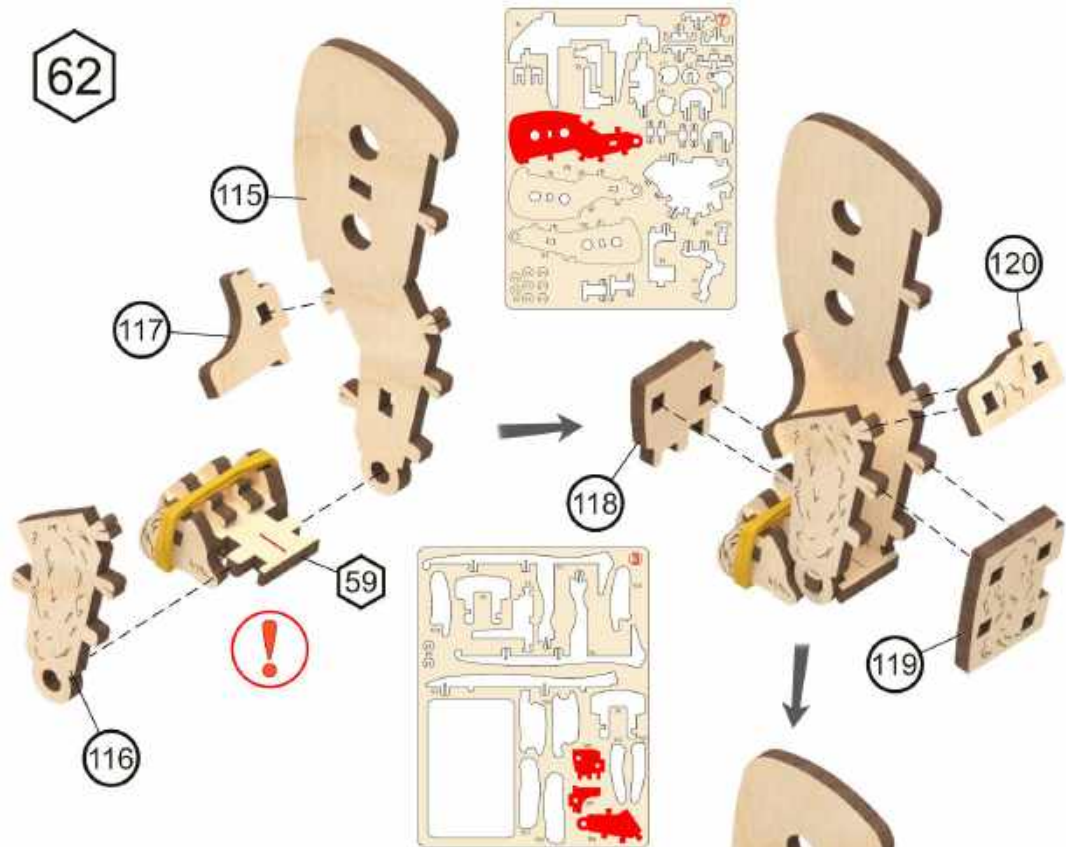

64

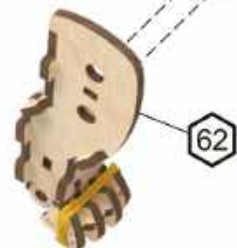

65



66

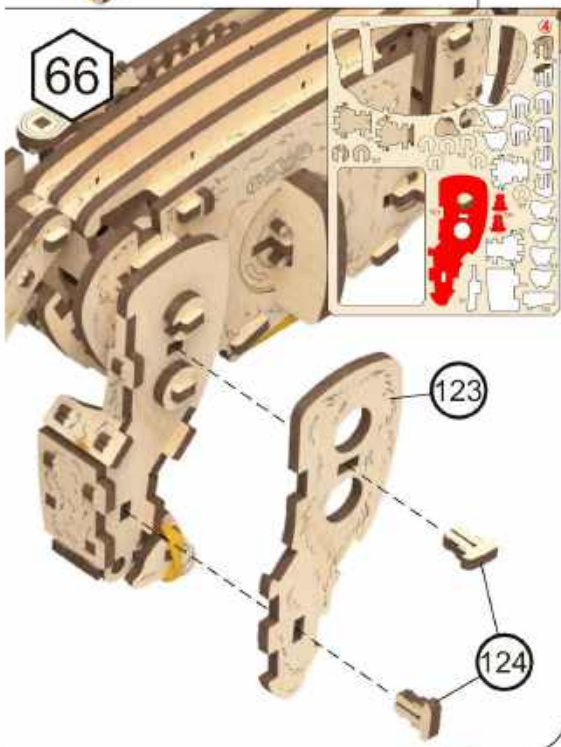

67

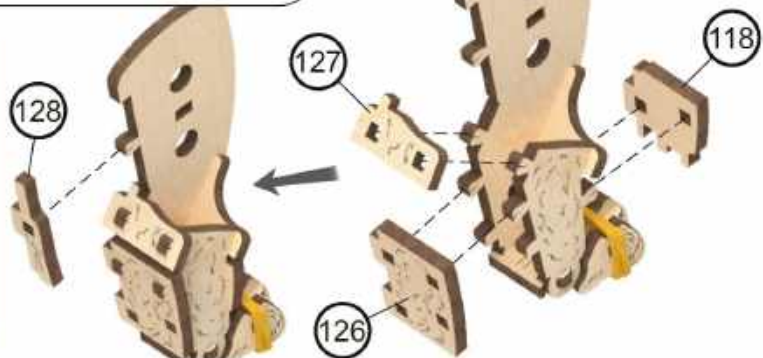
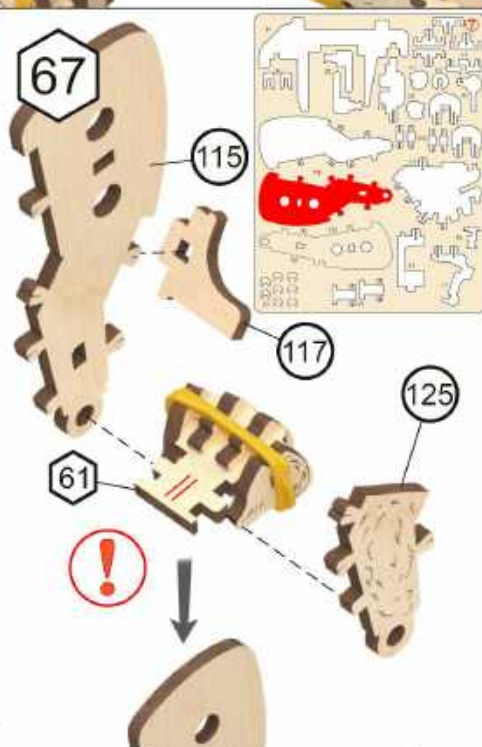

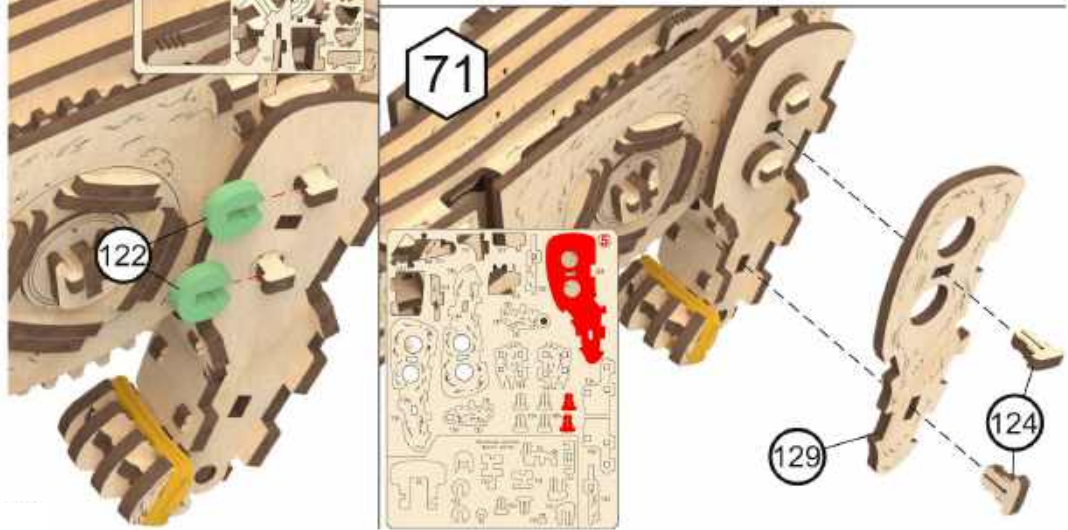
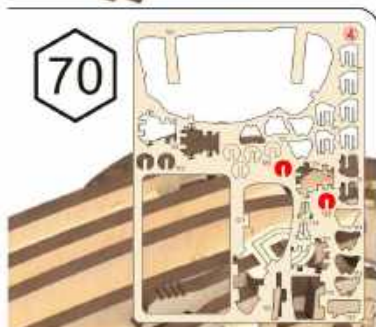
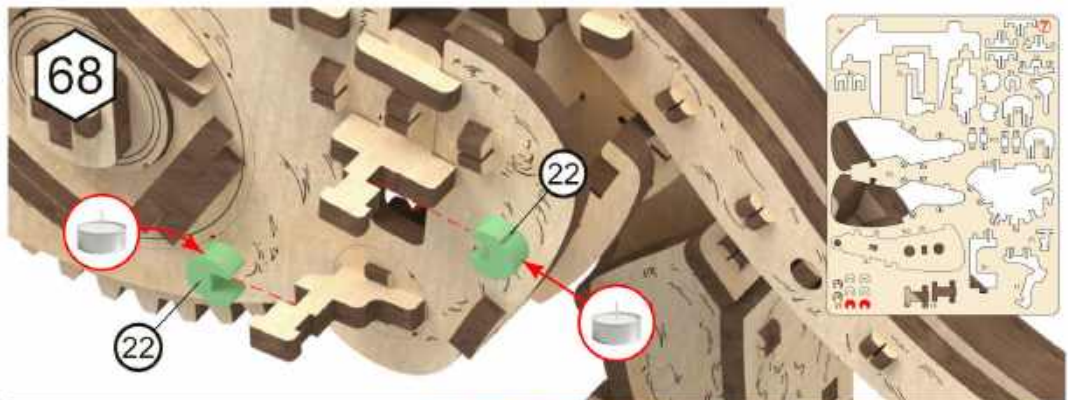

72

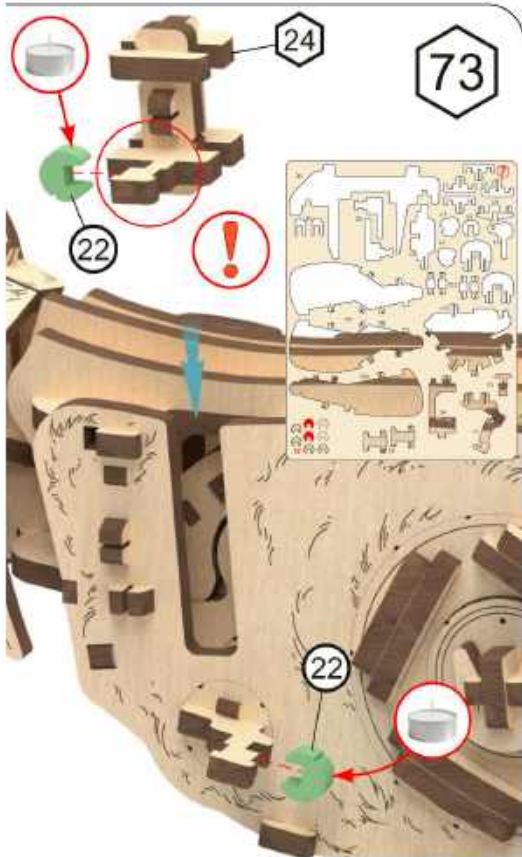
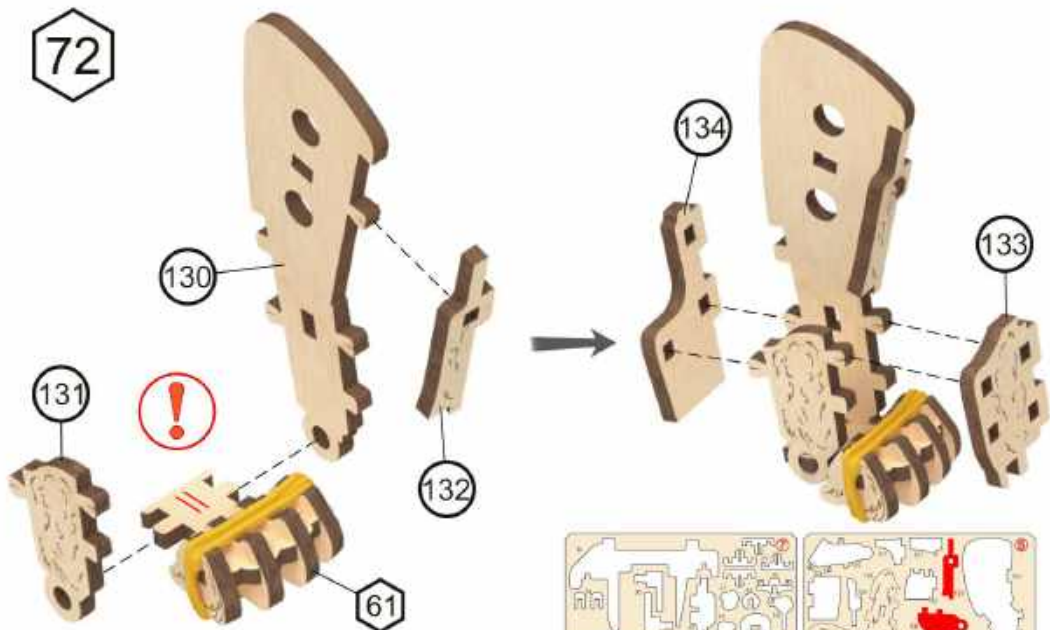

73

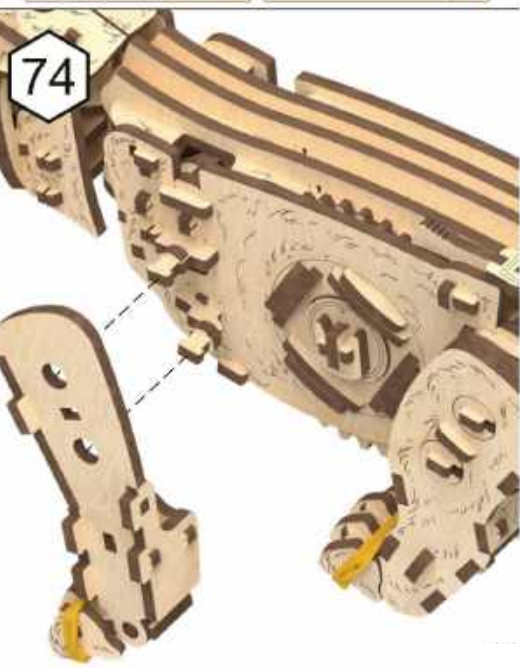
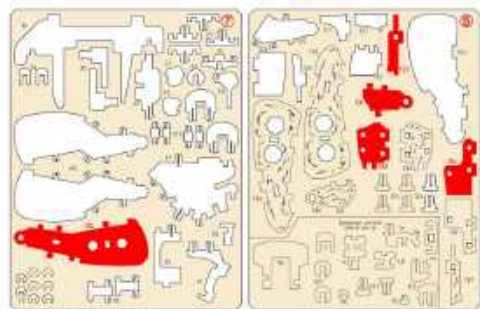

74

