

# Assembly Instruction



## GRAIN HARVESTING COMBINE GH800



- EN The ledge is for the squeezing the small details out of the board  
 PL Wypstę w linijce przeznaczony jest do wyciskania małych detali z arkusza sklejk  
 FR La proéminence est conçue pour aider à presser et enlever les petits détails de la feuille  
 ES La repisa es para apretar los pequeños detalles fuera del tablero  
 DE Der Vorsprung dient dazu, kleine Teile aus den Platten zu drücken  
 RU Выступ предназначен для выталкивания из листа мелких деталей  
 IT Le proiezioni riportate sui fogli di istruzione sono utili anche nella fase di smontaggio per estrarre i pezzi  
 CN 輔助測量尺可幫助取出或壓接細小零件時使用  
 CZ Použijte k vytažení malých částí z desky

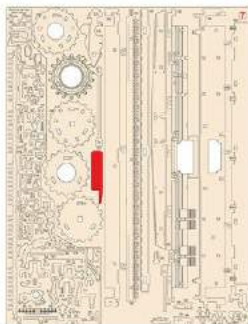

- EN Cut it with a razor blade  
 PL Odcinaj nożem do kłopot  
 FR Couper avec un cutter  
 ES Cortar con un bisturi  
 DE Mit Rasierklinge durchschneiden  
 RU Обрезать канцелярским ножом  
 IT Tagliare con un coltello da cancelleria  
 CN 用刀片切割  
 CZ Vyřizněte řezákem



- EN Details should rotate freely  
 PL Swobodnie obracanie  
 FR Libre rotation  
 ES Rotación libre  
 DE Auf freie Rotation achten  
 RU Свободное вращение  
 IT Rotazione libera  
 CN 旋轉地旋轉  
 CZ Části by se měly volně otáčet



- EN Pay attention  
 PL Uwaga  
 FR Faire attention  
 ES Prestar atención  
 DE Achtung  
 RU Уделить внимание  
 IT Prestare attenzione  
 CN 請注意  
 CZ Pozor



- EN Remove the burrs with sandpaper  
 PL Usunąć zadziory papierem ściernym  
 FR Retirer les bavures avec du papier à polir  
 ES Quitar las rebabas con el papel esmeril  
 DE Grate mit Schleifpapier entfernen  
 RU Удалить заусенцы наждачной бумагой  
 IT Sbavare con carta vetrata  
 CN 用砂紙去除毛刺  
 CZ Vyhlaďte smirkových papírem



- EN Wax it with a candle  
 PL Posmaruj za pomocą świecy parafinowej  
 FR Graisser avec une bougie de paraffine  
 ES Engrasar con ayuda de una vela de parafina  
 DE Mit einer Kerze wachsen  
 RU Смазать парафиновой свечой  
 IT Lubrificare con candela di paraffina  
 CN 用于蠟燭上蠟海滑  
 CZ Navoskujte svíčkou



- EN Glue is recommended  
 PL Zaleca się użycie kleju  
 FR Recommandé d'utiliser de la colle  
 ES Recomendado usar pegamento  
 DE Es wird empfohlen, Kleber zu verwenden  
 RU Рекомендуется использовать клей  
 IT Si consiglia di utilizzare la colla  
 CN 建议使用胶水  
 CZ Doporučuje se použít lepidlo

EN The manufacturer reserves the right to make changes in the design of the product, not worsening its technical characteristics. Information about the changes made may not be present in this manual.

PL Producent zastrzega sobie prawo do zmiany konstrukcji wyrobu bez pogorszenia jego właściwości technicznych. Niniejsza instrukcja może nie zawierać informacji o zmianach.

FR Le constructeur se réserve le droit d'apporter des modifications dans la construction du produit à condition si elles ne portent atteinte à ses caractéristiques techniques. Les renseignements sur les modifications apportées peuvent ne pas être dans la présente notice.

ES El fabricante se reserva el derecho de introducir modificaciones en la construcción del producto, que no empeoran sus características técnicas. Datos sobre modificaciones introducidas pueden no aparecer en esta instrucción.

DE Der Hersteller behält sich das Recht auf Designänderungen, die die technischen Merkmale und Funktionen nicht negativ beeinflussen, vor.

RU Производитель оставляет за собой право вносить изменения в конструкцию изделия, не ухудшающие его технические характеристики. Сведения о внесенных изменениях могут отсутствовать в настоящей инструкции.

IT Il produttore si riserva il diritto di apportare modifiche al design del prodotto, non peggiorando le sue caratteristiche tecniche.

Informazioni sulle modifiche apportate potrebbero non essere presenti in questo manuale.

CN 制造商保留对产品设计的权利，一切改良旨在增强产品的技术性能。改良处若未出现在手册中，敬请谅解

CZ Vyrobae si vyhrazuje pravo na takove zmeny v designu produktu, které nebudou mit za následek zhoršení technických vlastností.

Informace o změnách nemusí být v návodu uvedeny.

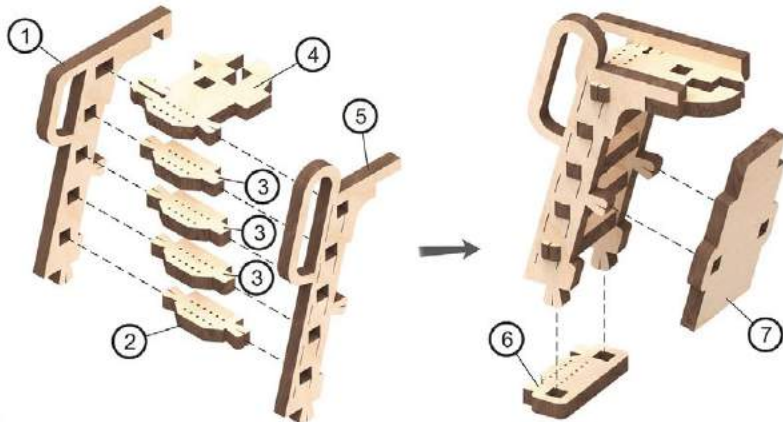

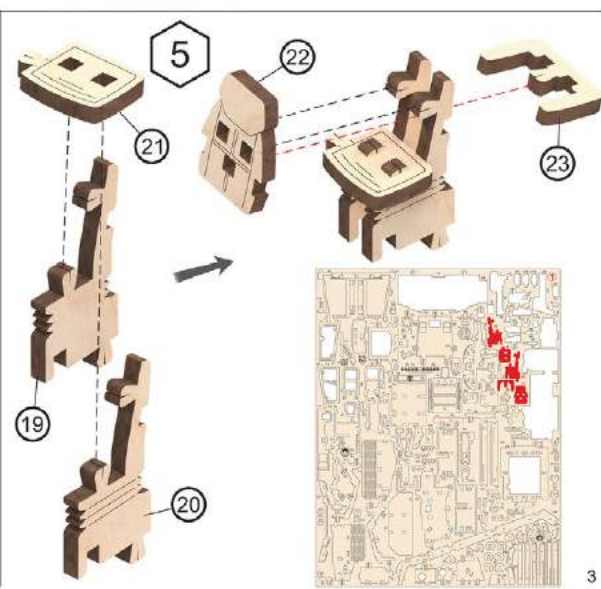
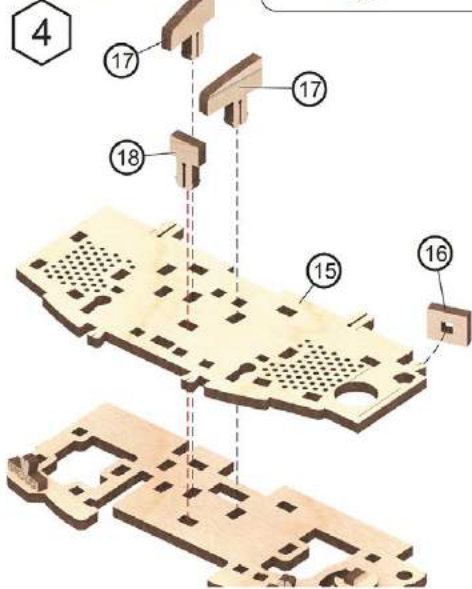
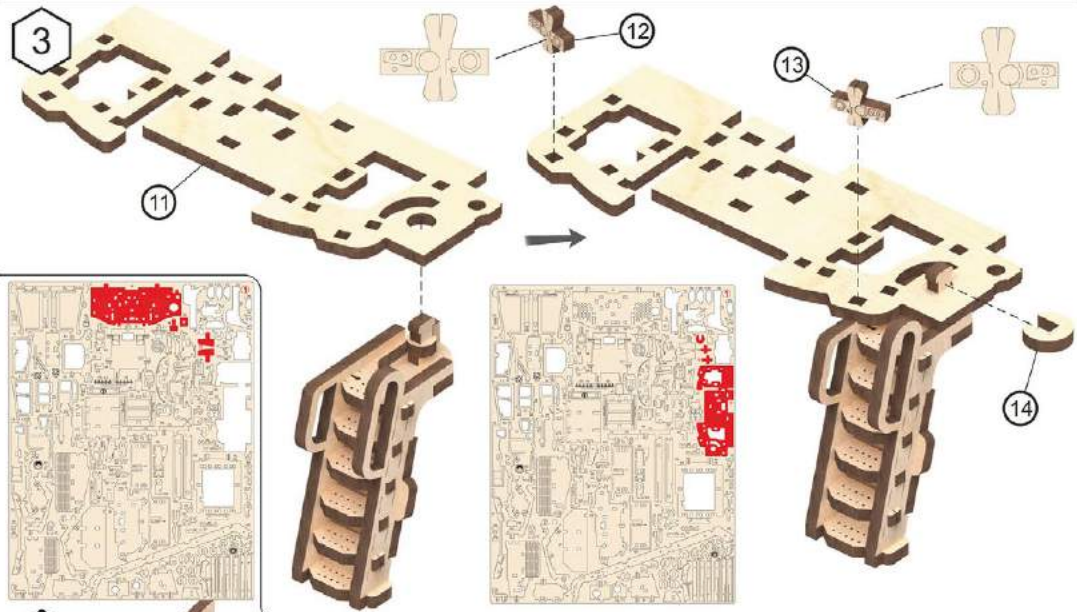
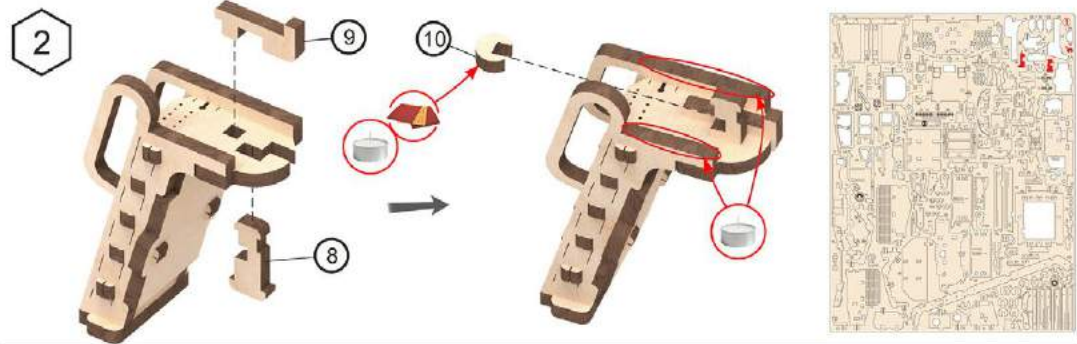

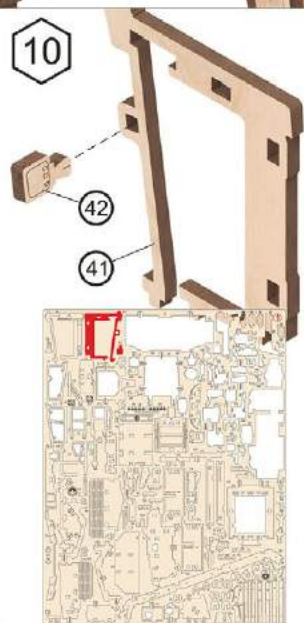
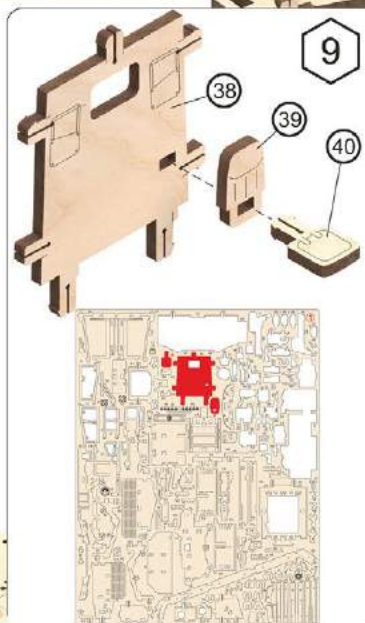
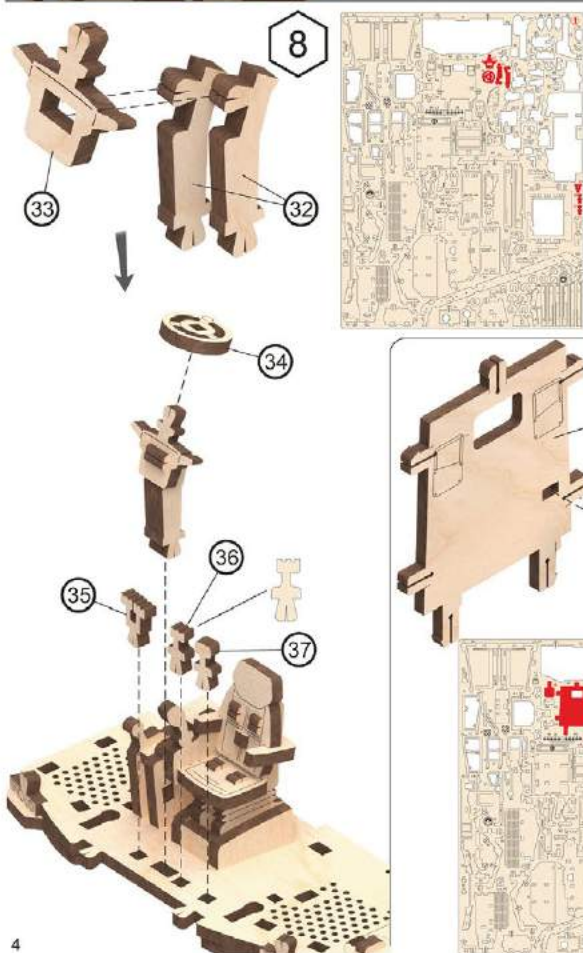
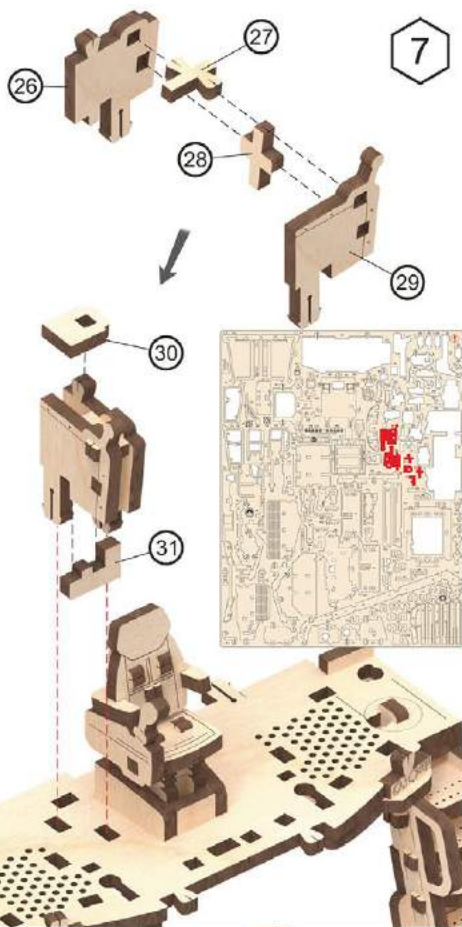
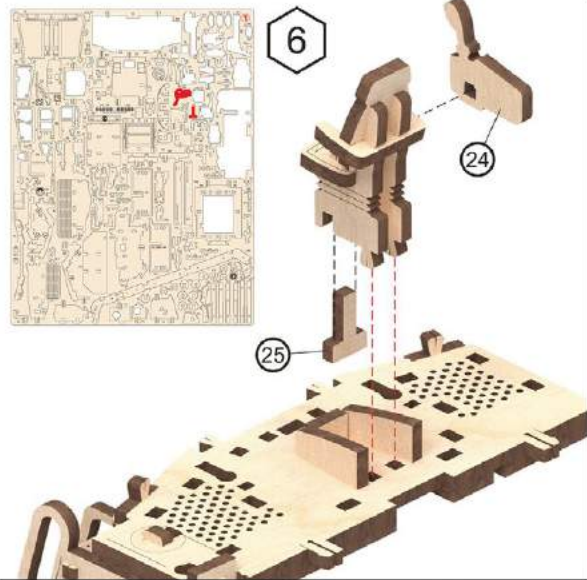

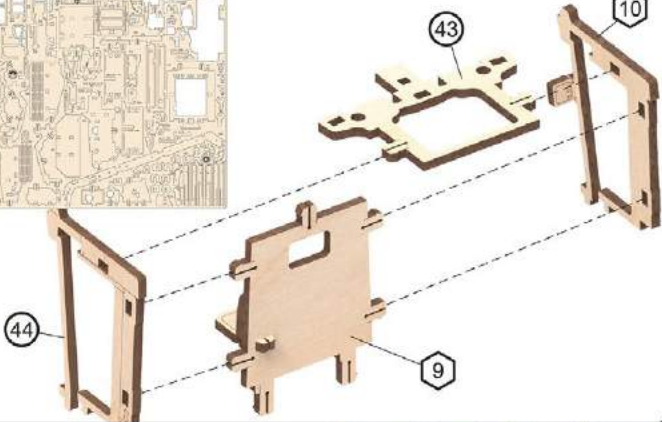
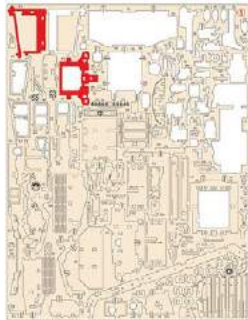

11

12

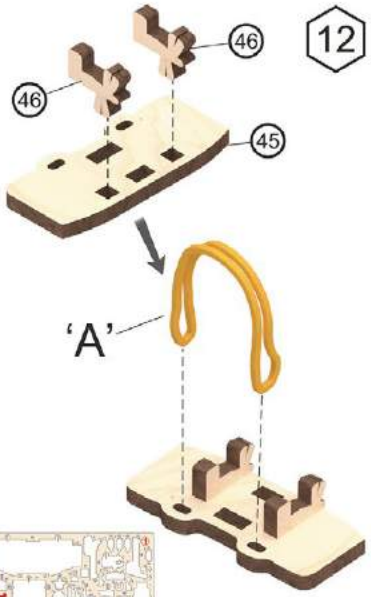

'A'

13

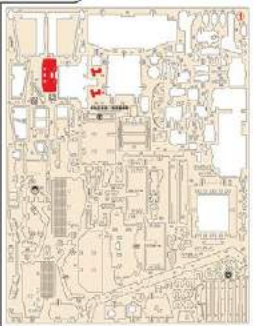
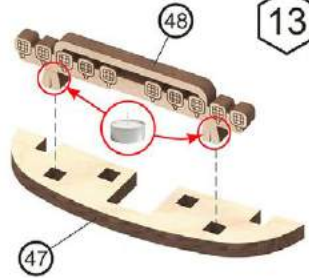

14

15

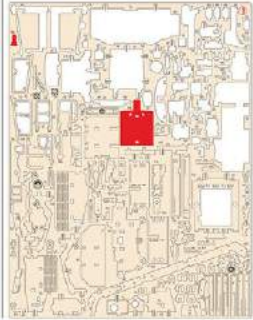
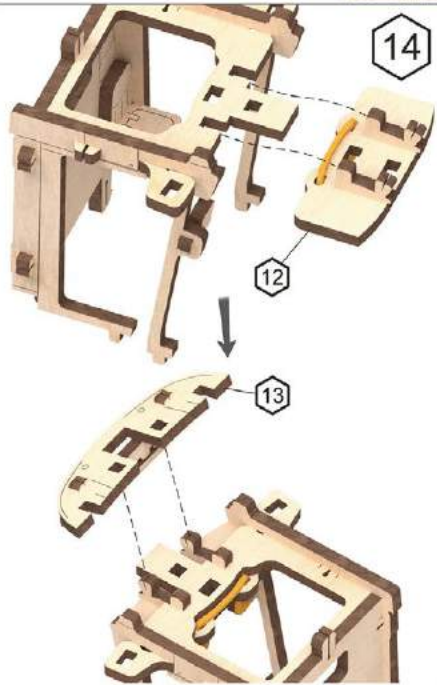



16

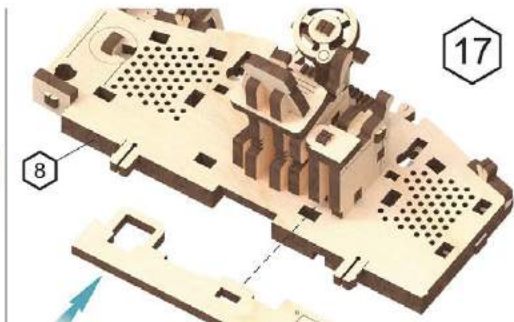
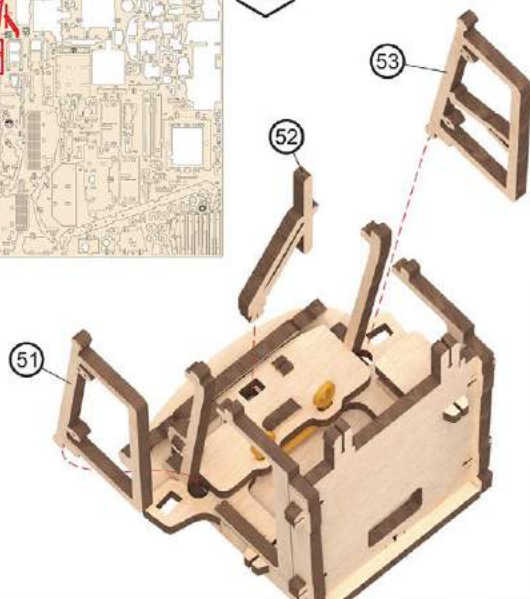

17

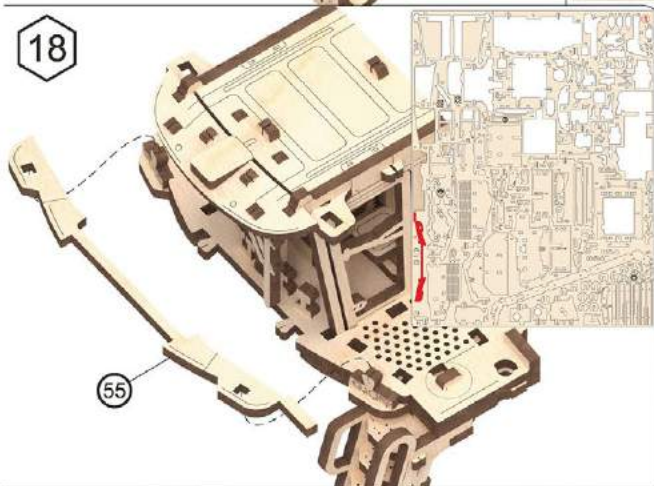
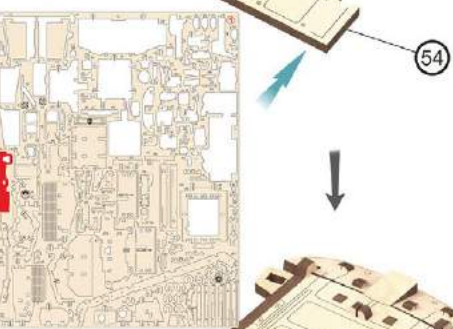

18



16

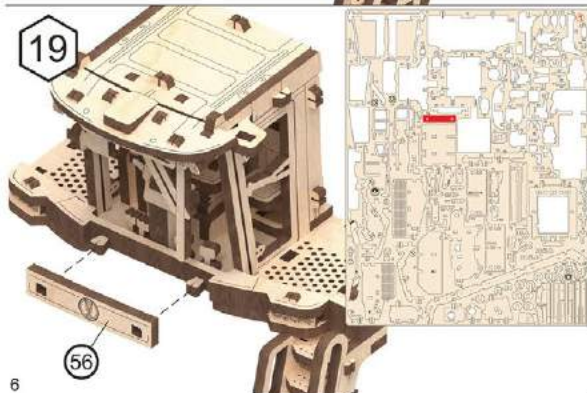

19

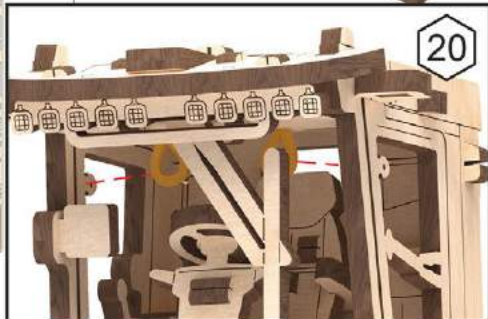

20

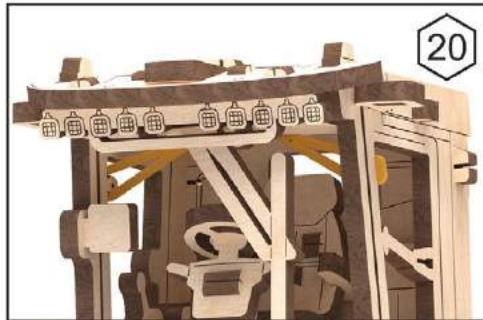

20

21

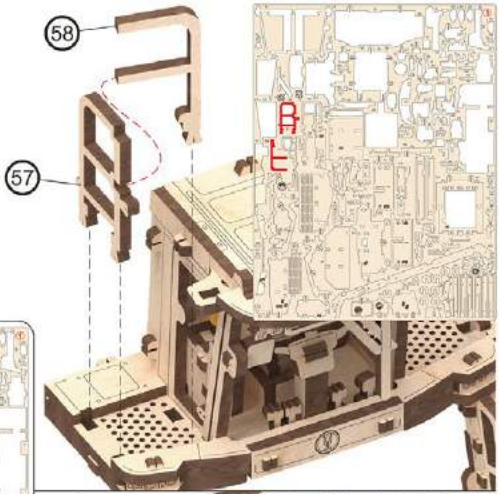

58

57

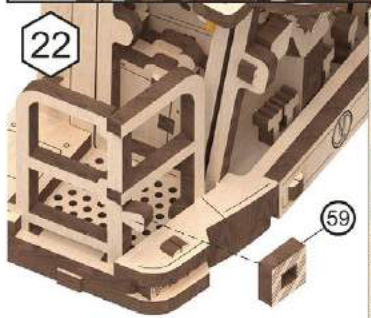

22

59

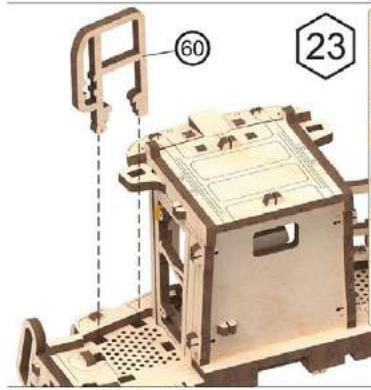

60

23

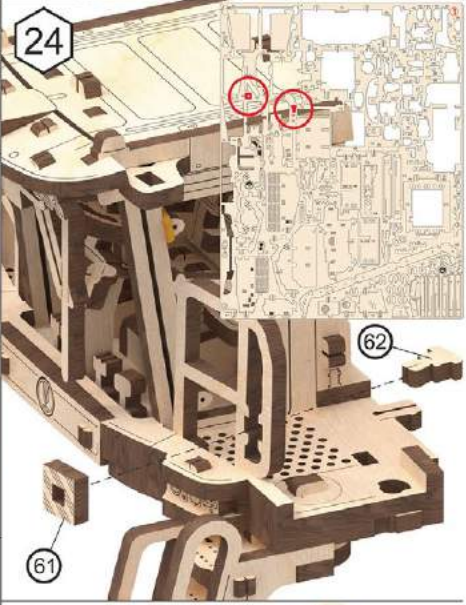
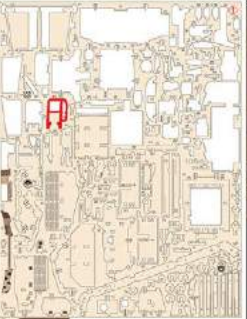

24

62

61

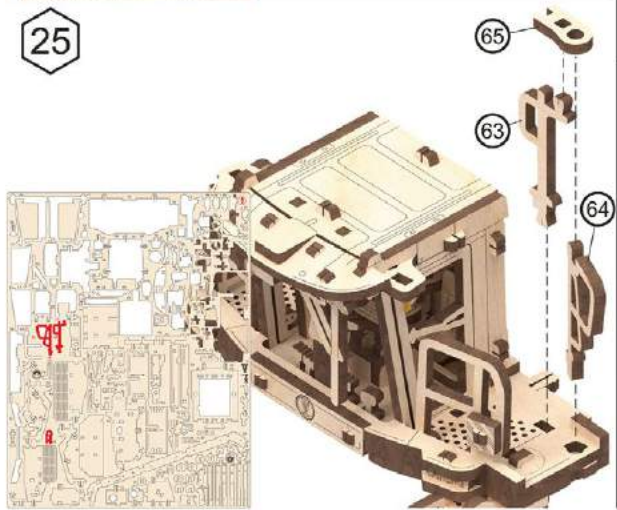

25

65

63

64

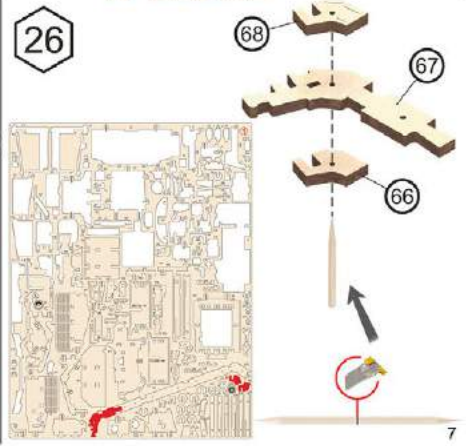

26

68

67

66

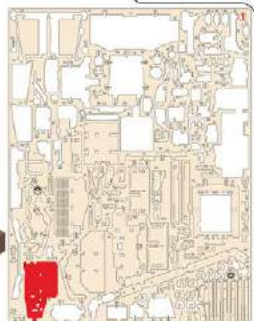
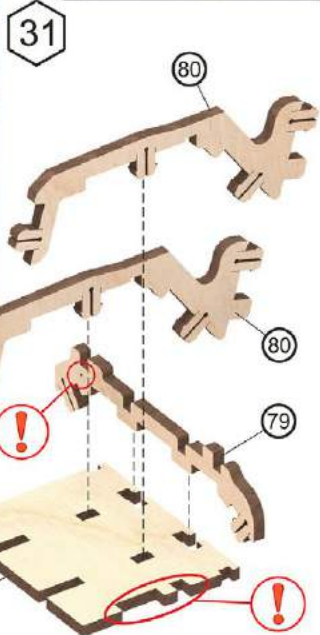
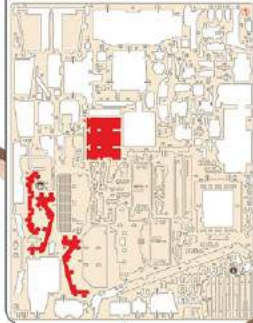
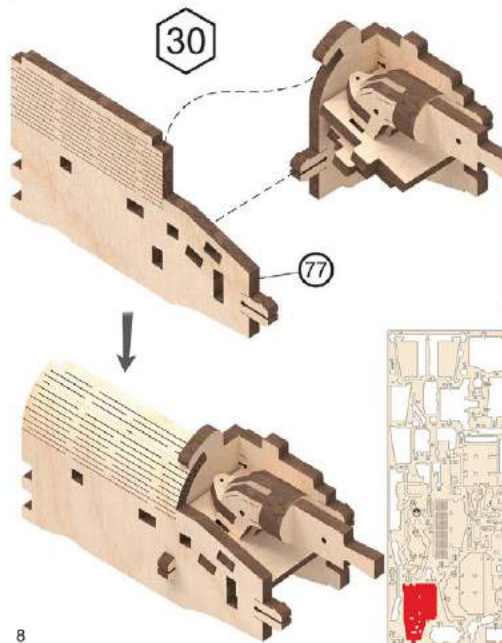
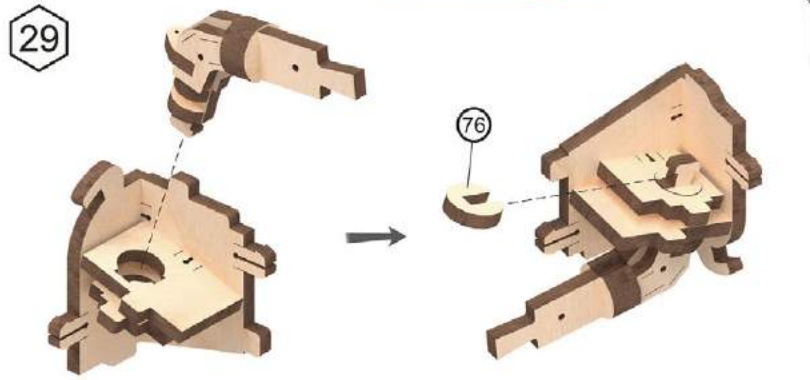
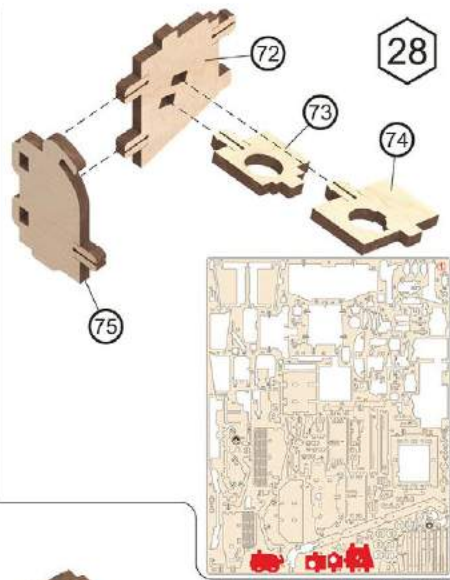
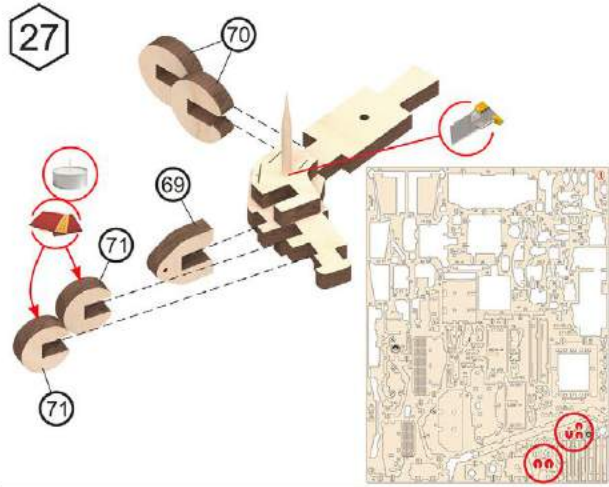

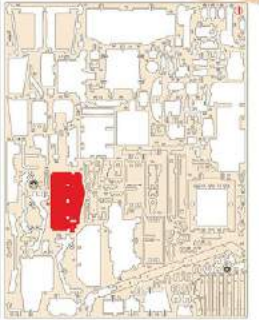
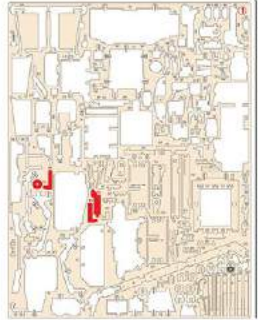
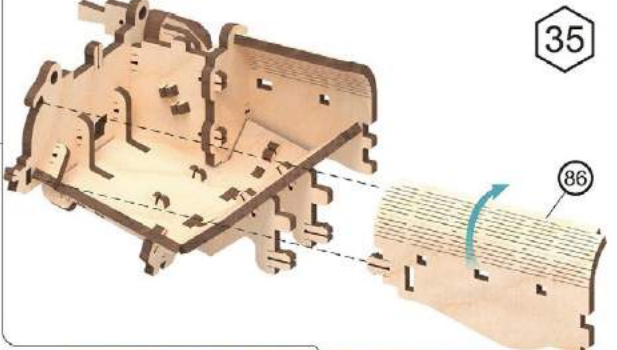
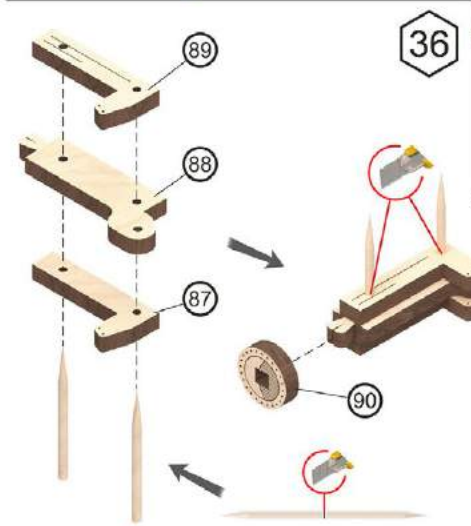
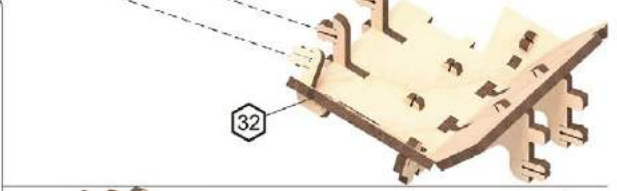
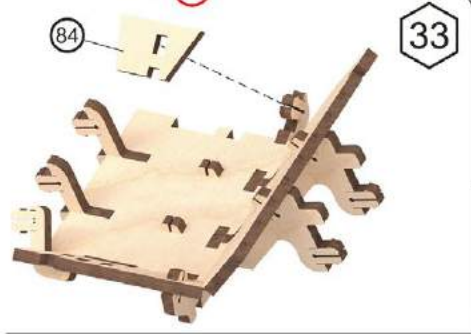
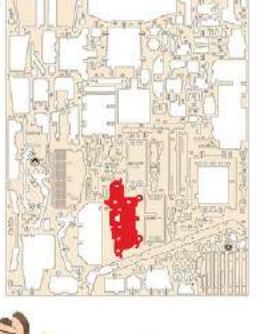
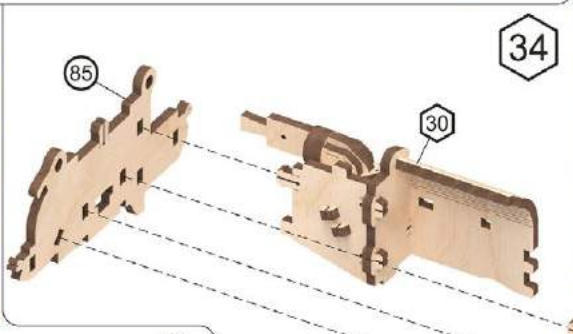
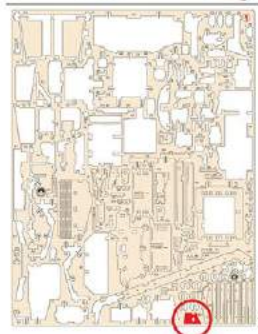
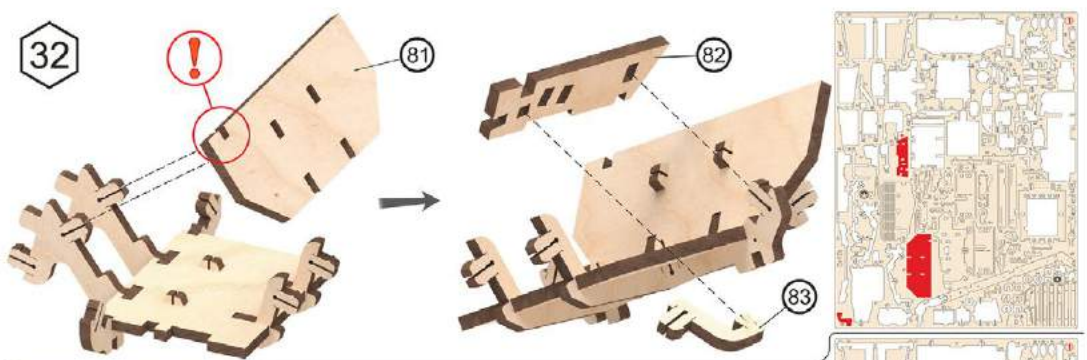

37

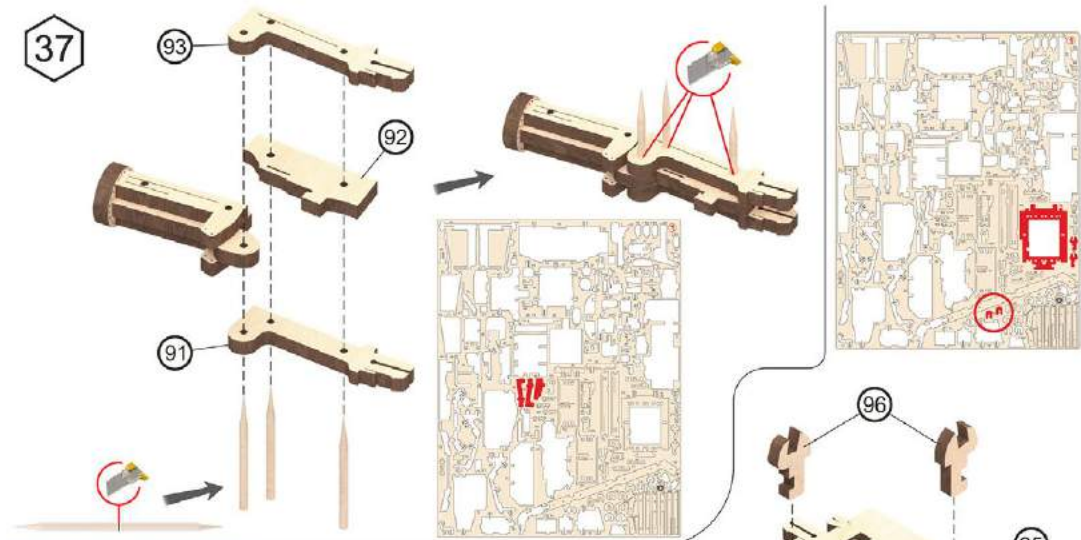

38

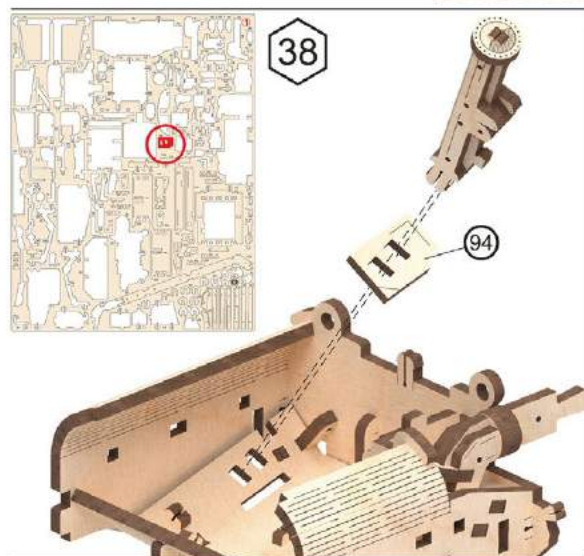

39

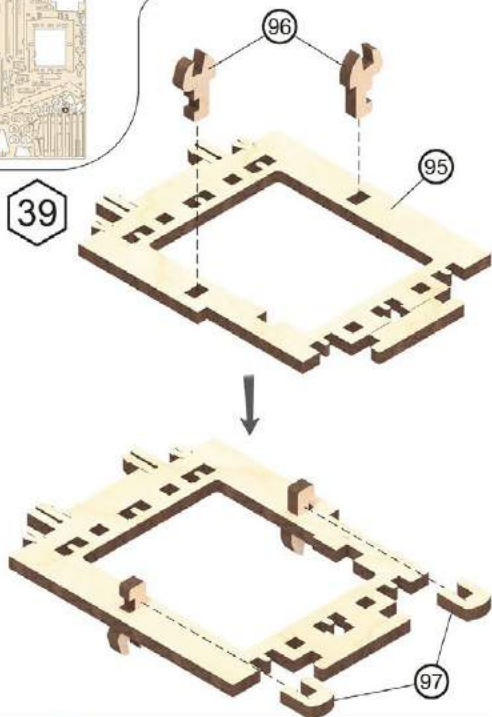

40

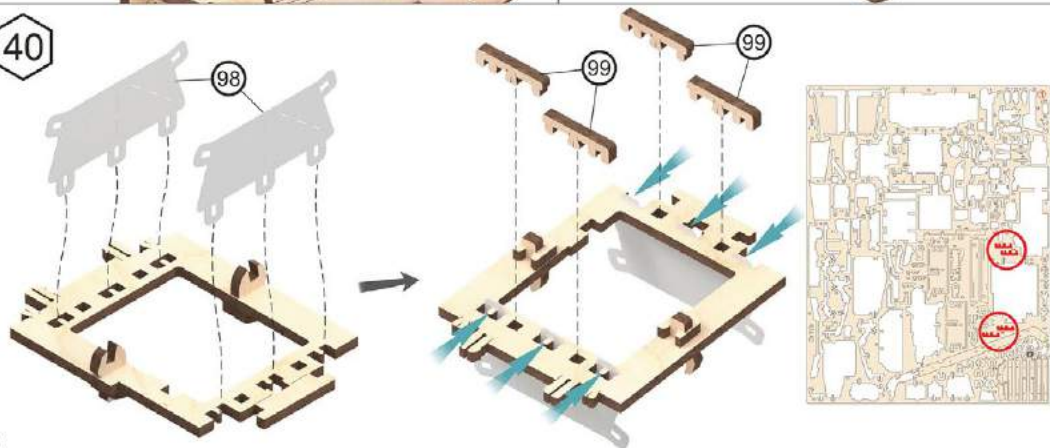

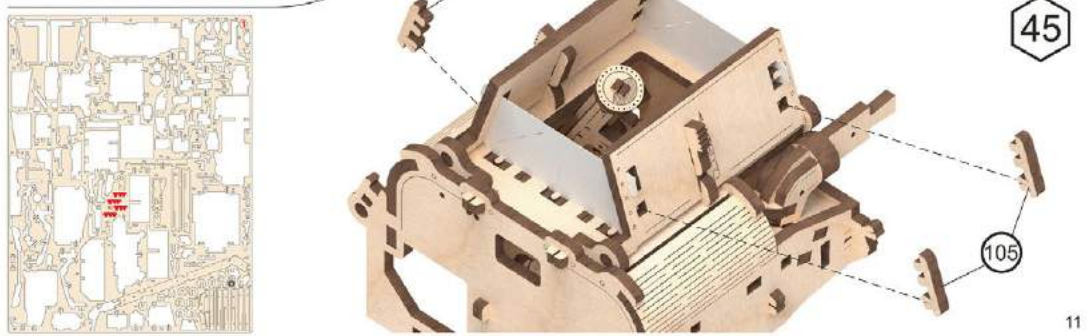
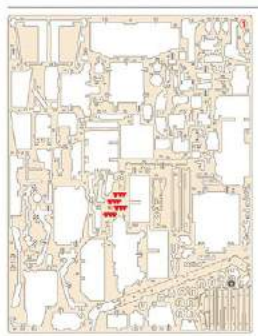
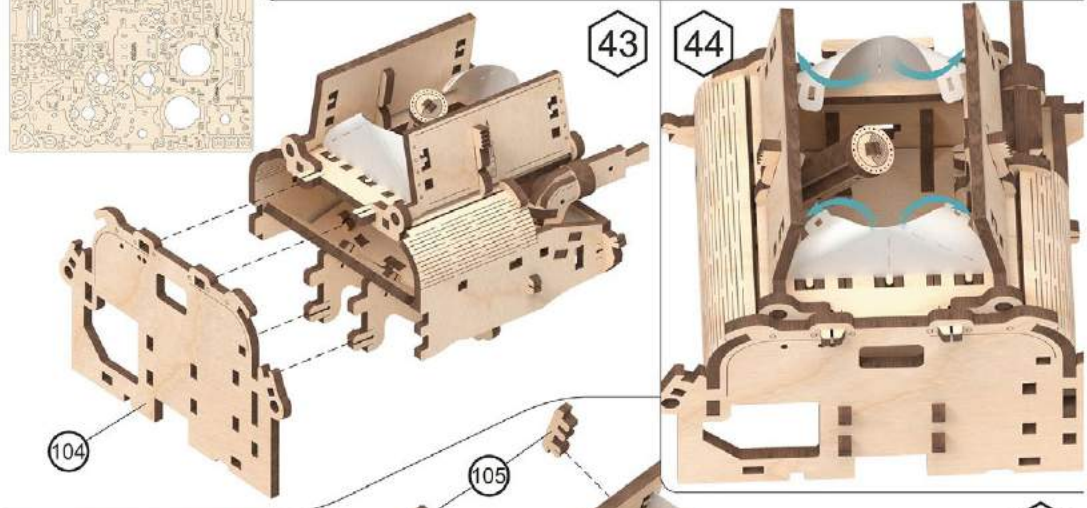
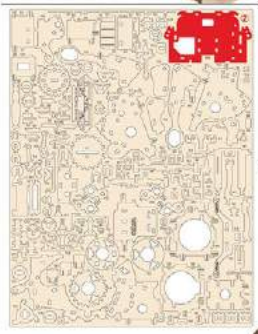
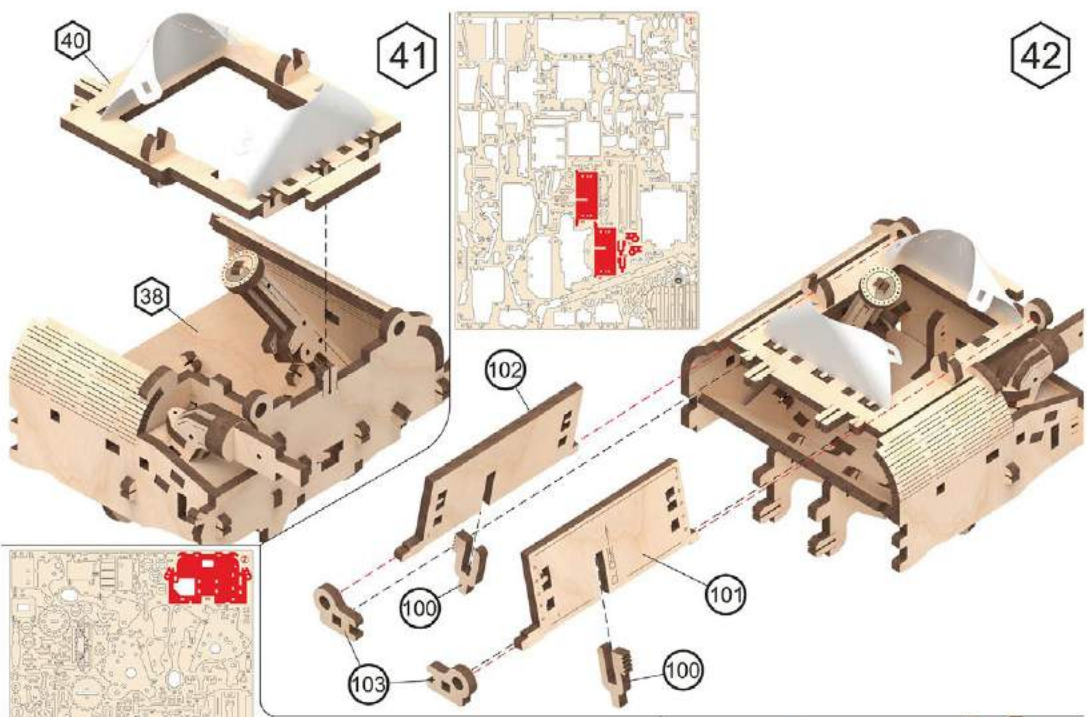

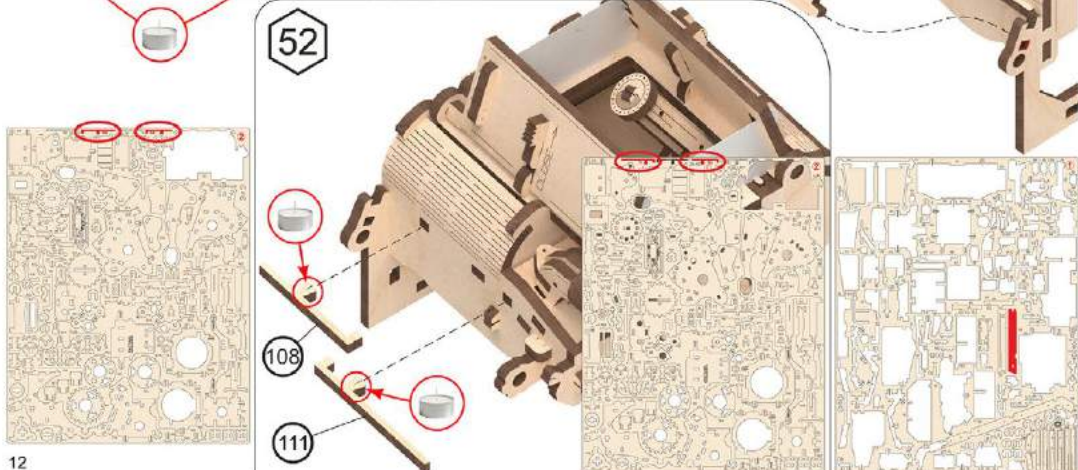
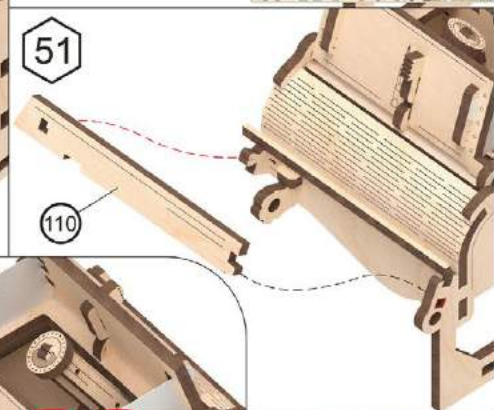
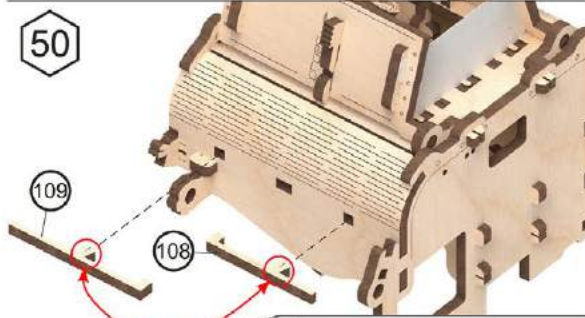
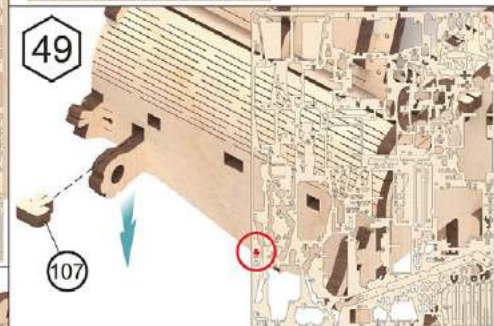
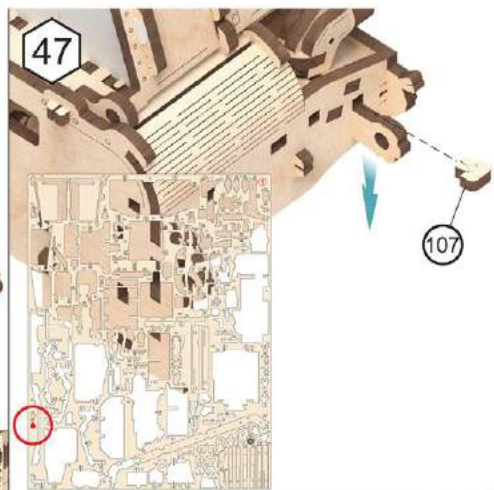
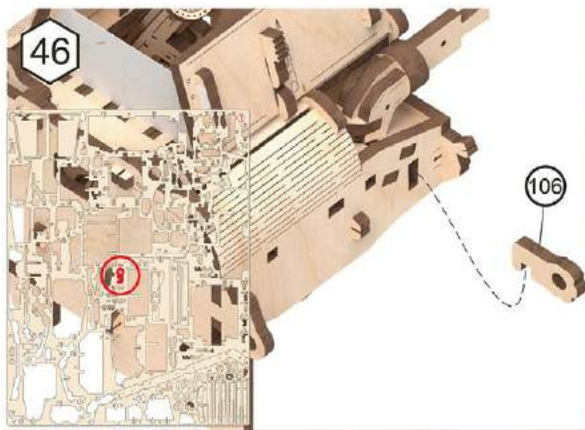

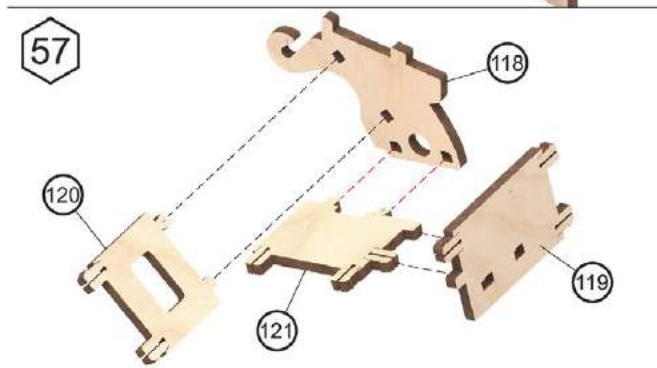
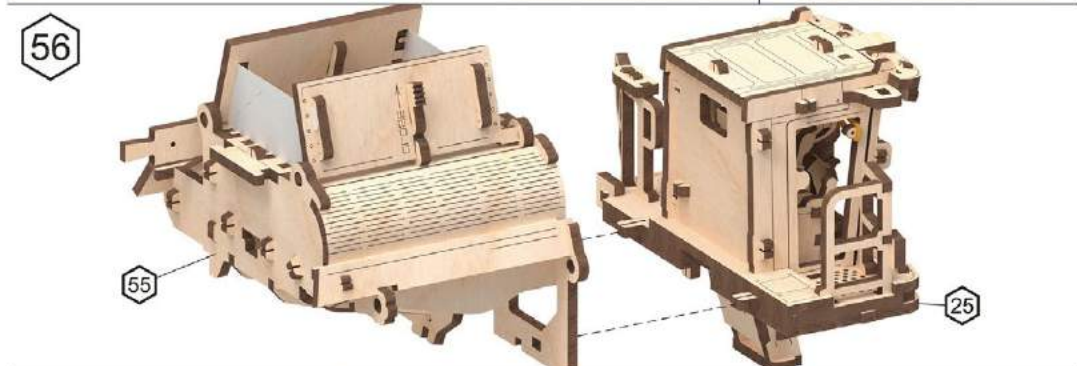
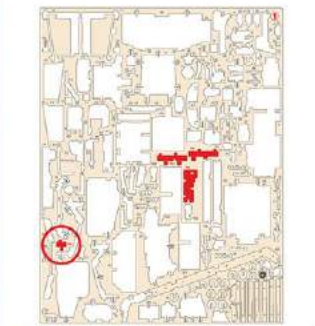
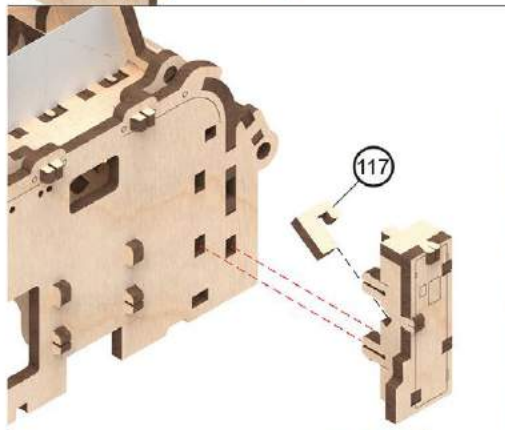
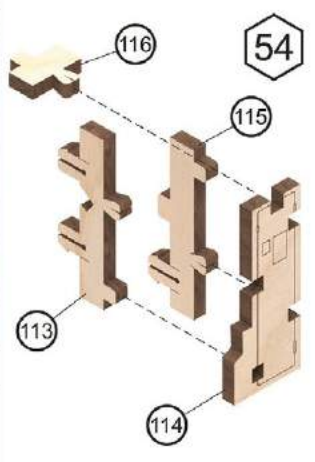
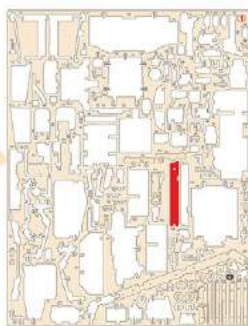
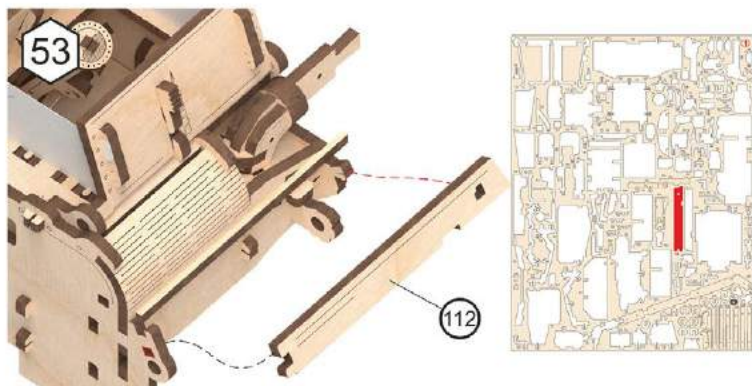

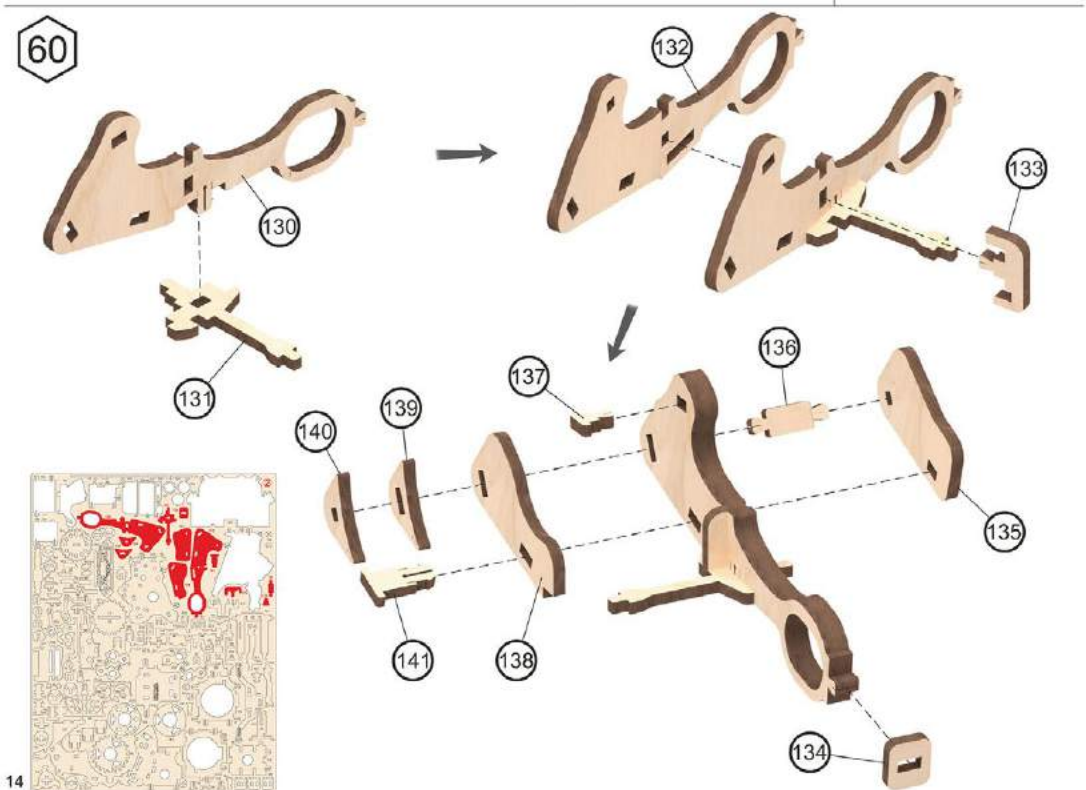
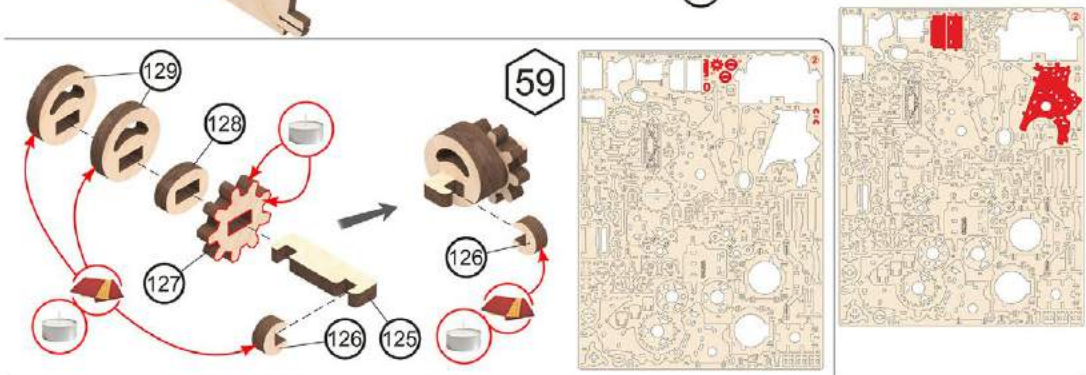
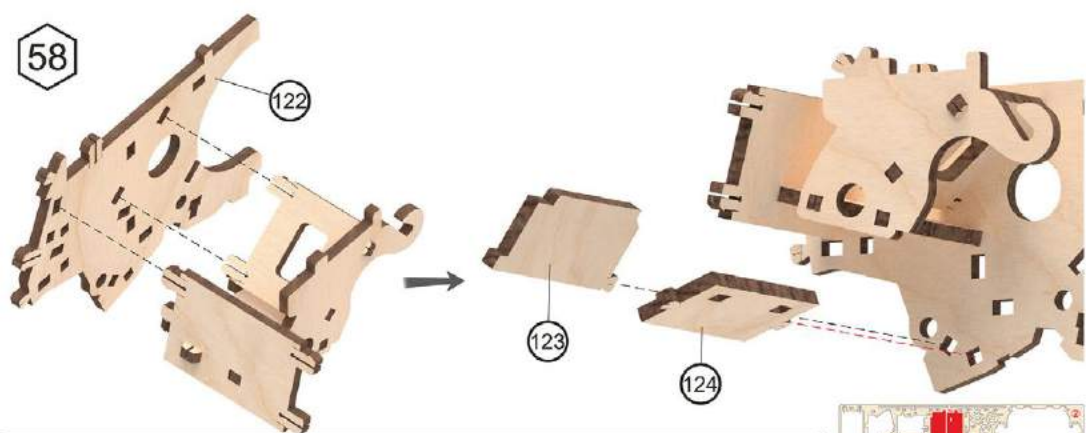

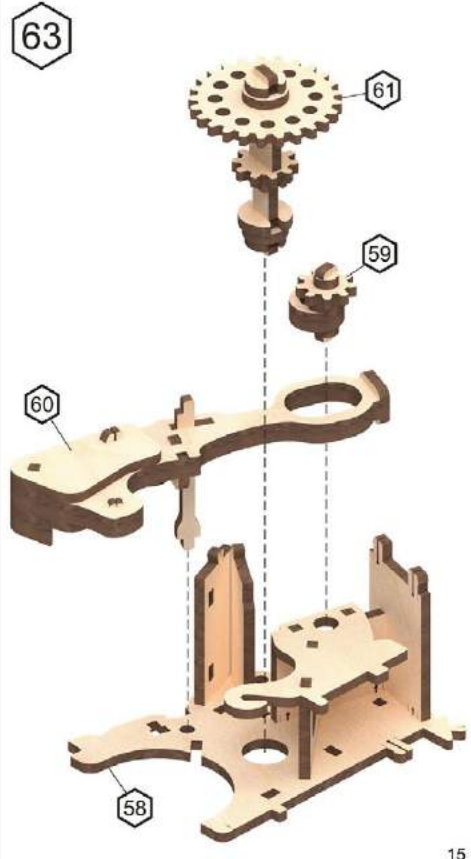
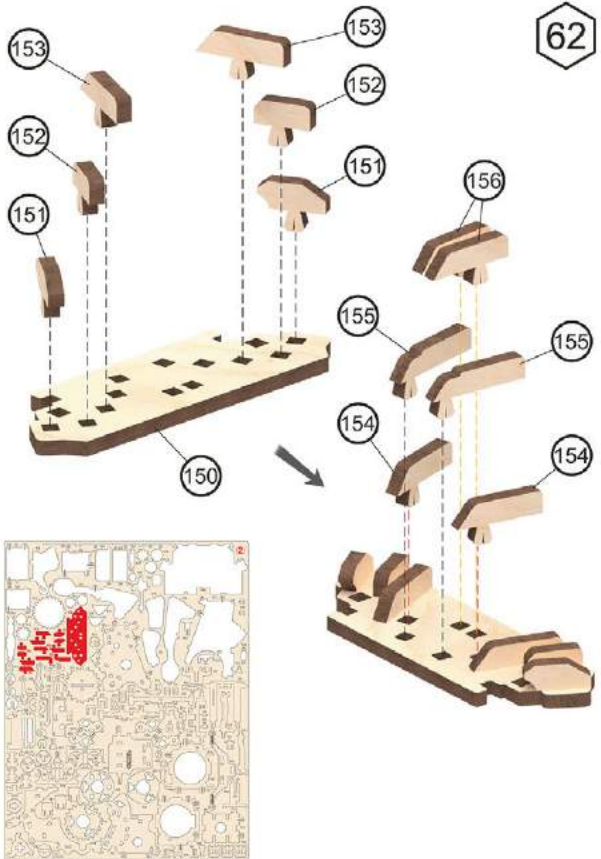
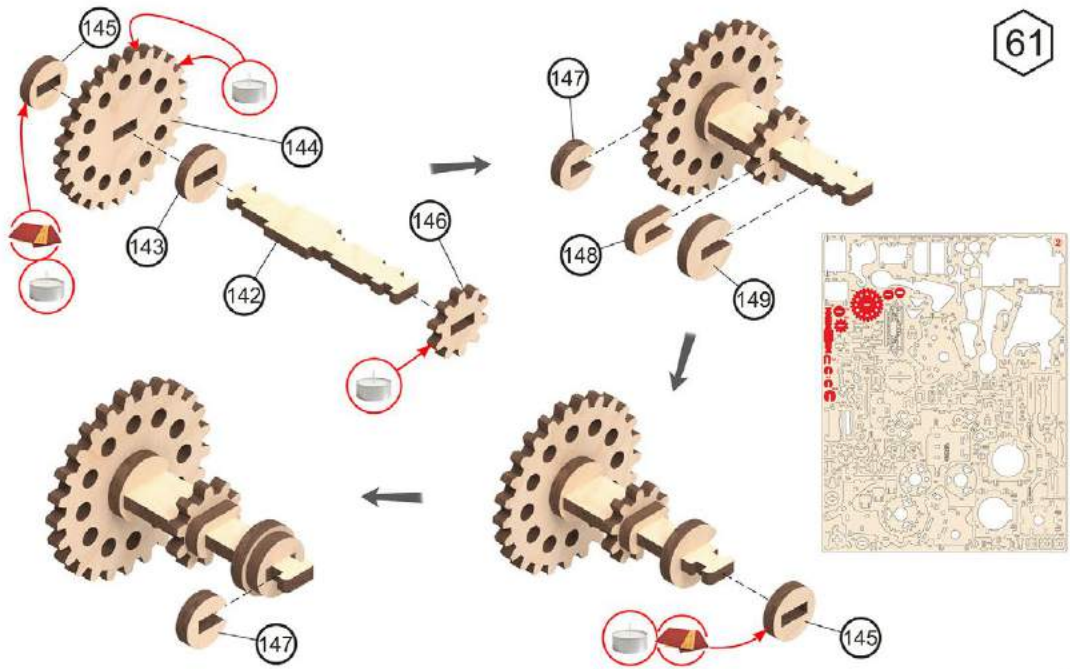

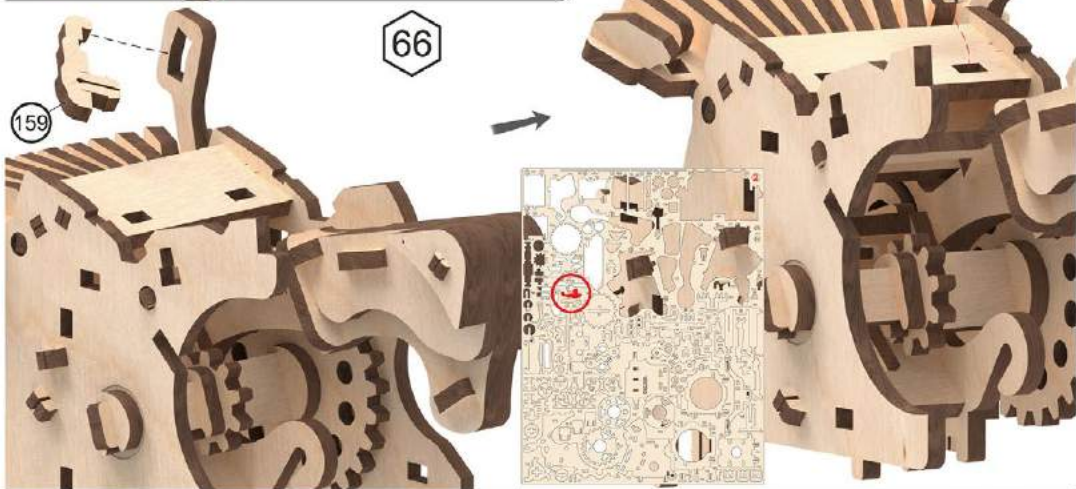
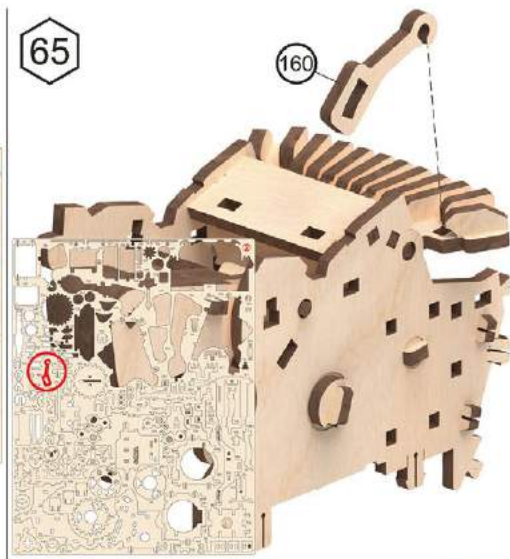
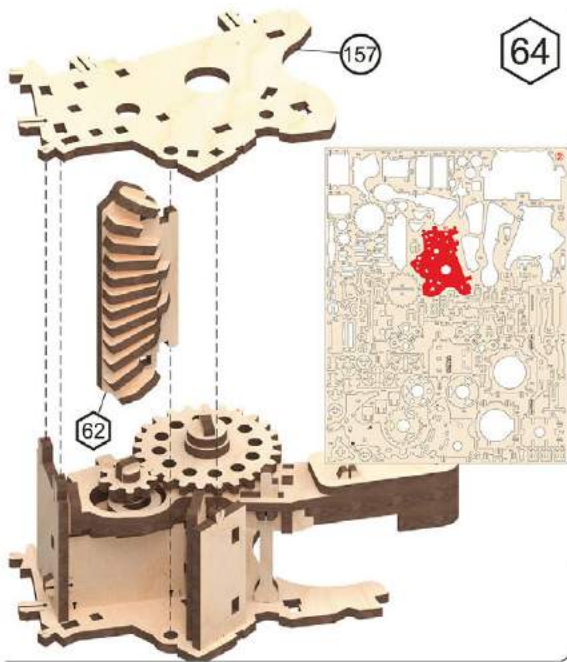

69

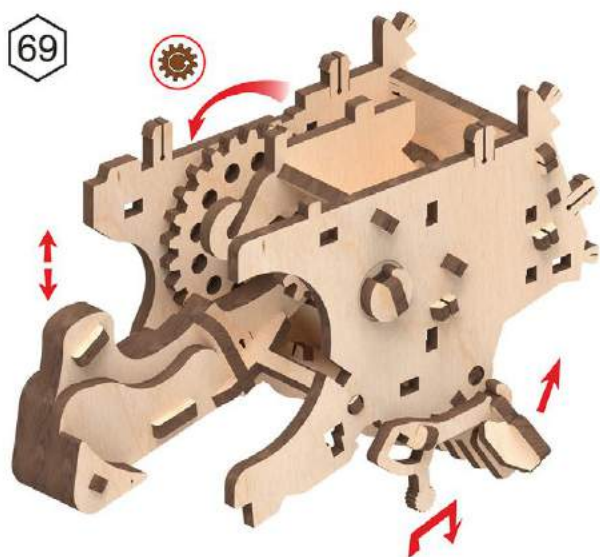

70

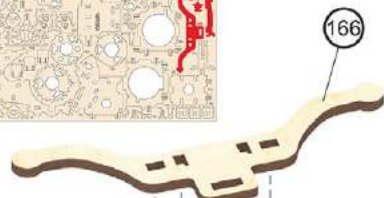

165

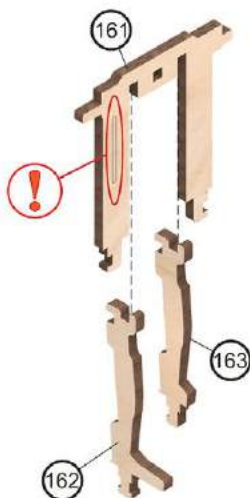

164

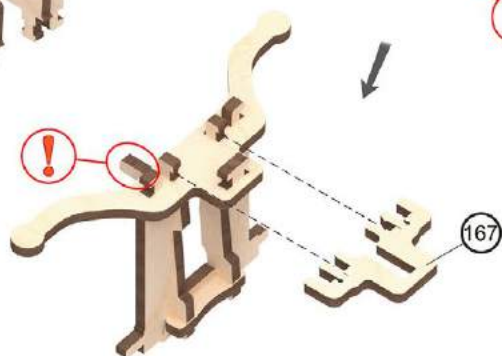
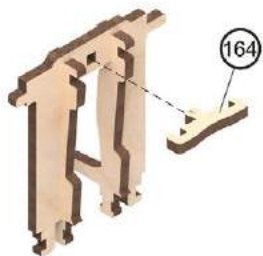

163

162

71

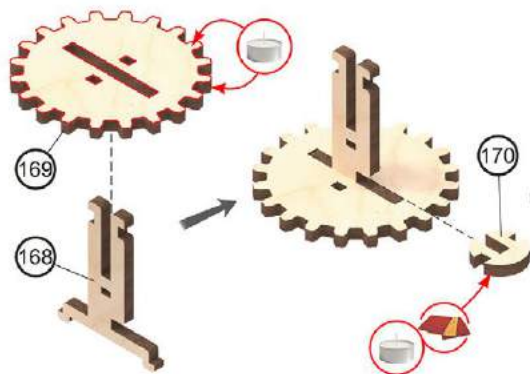

171

170

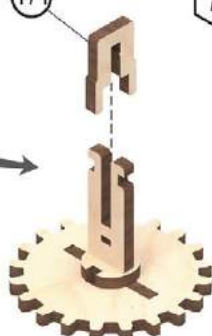

72

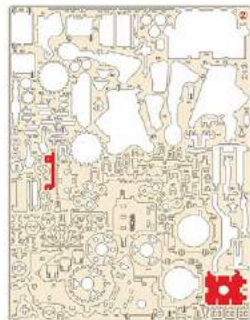
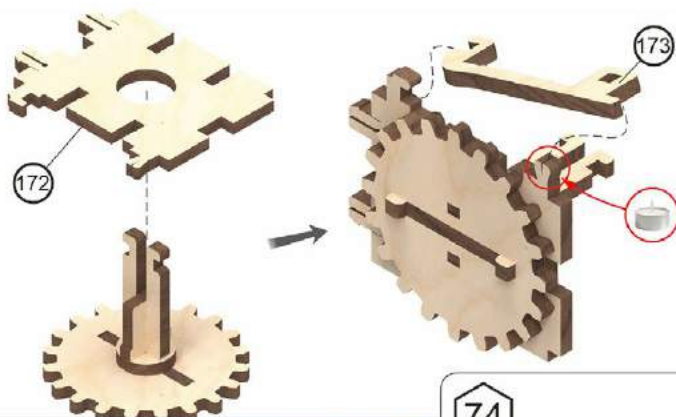

73

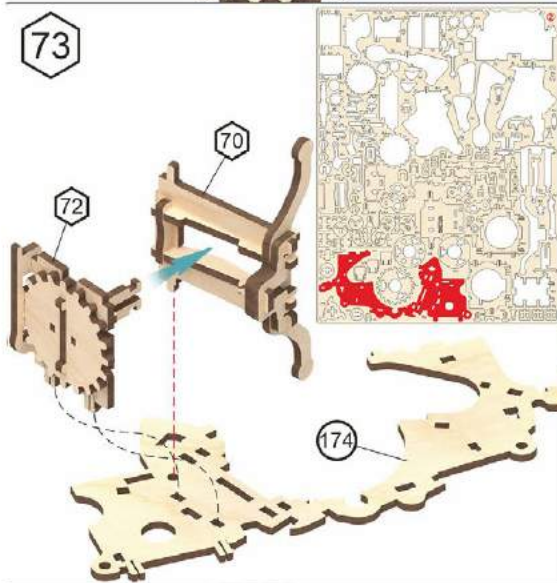

74

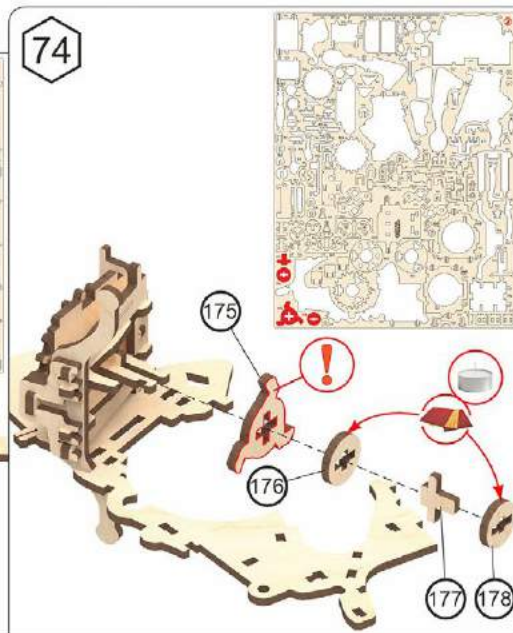

75

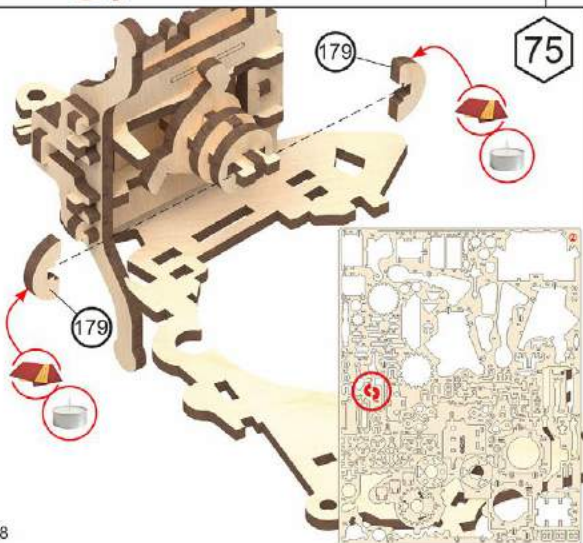

76

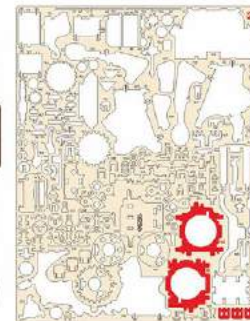
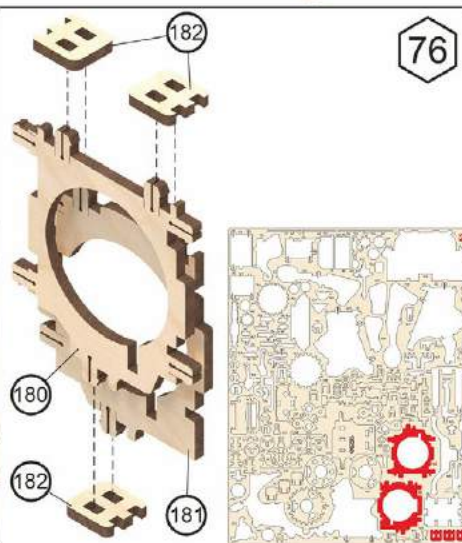

77

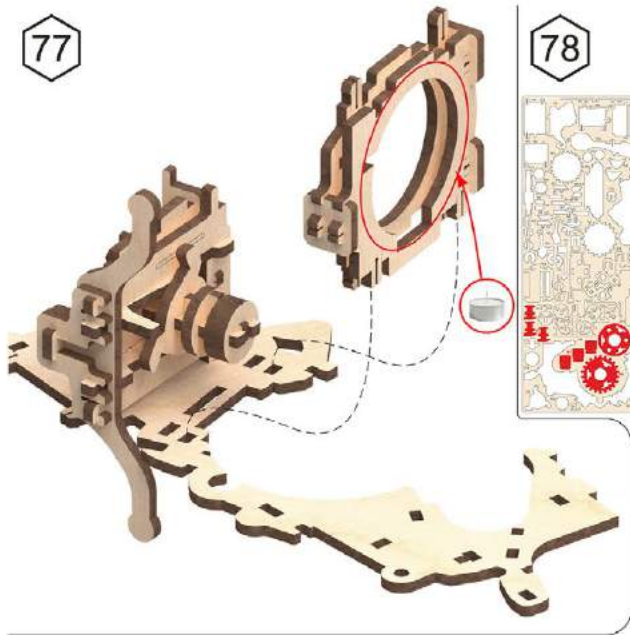

78

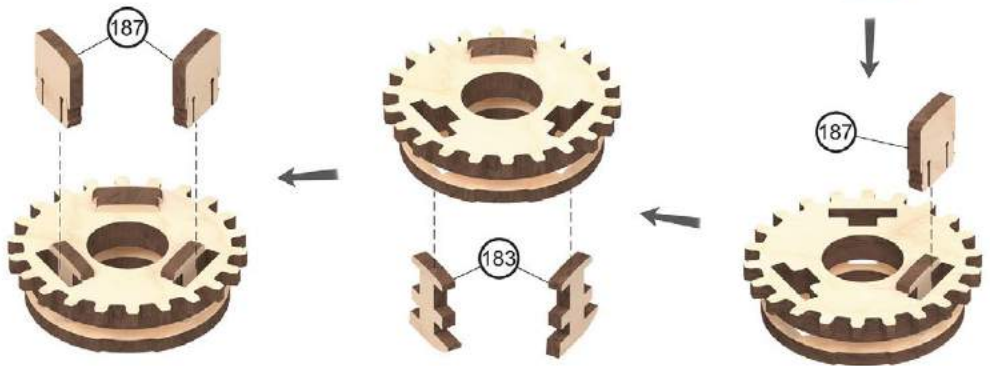
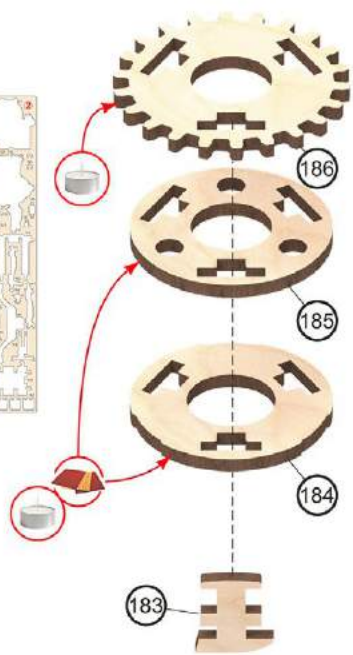
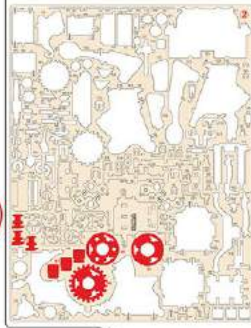

79

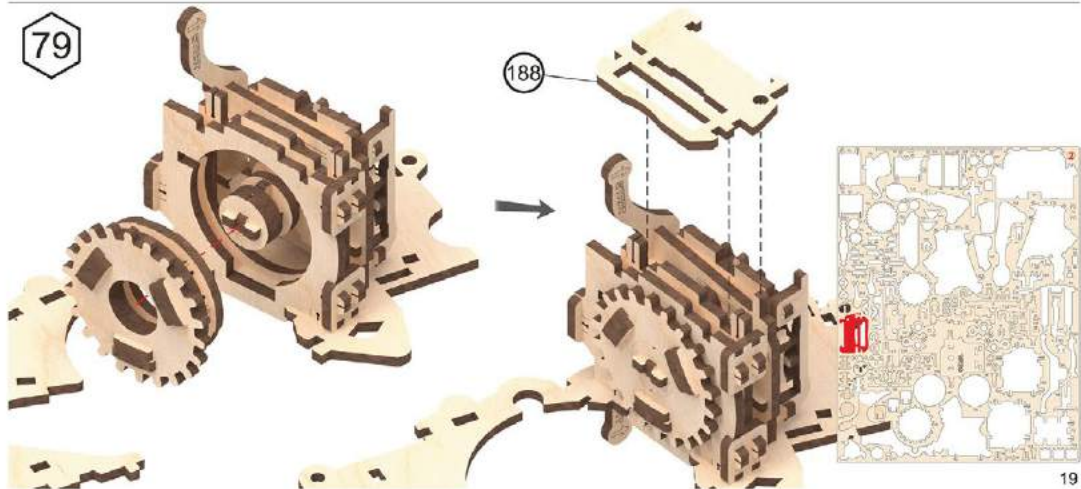

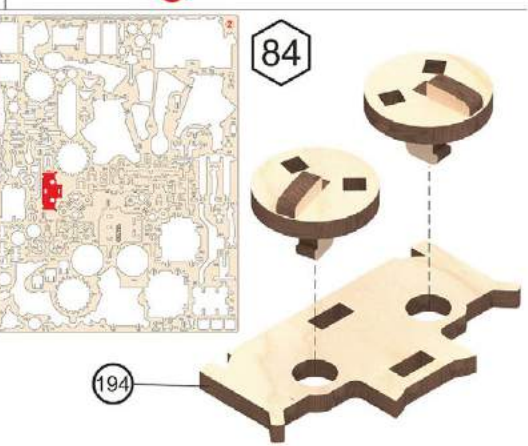
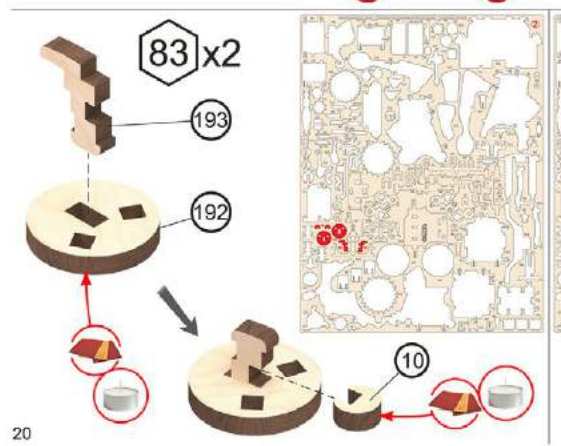
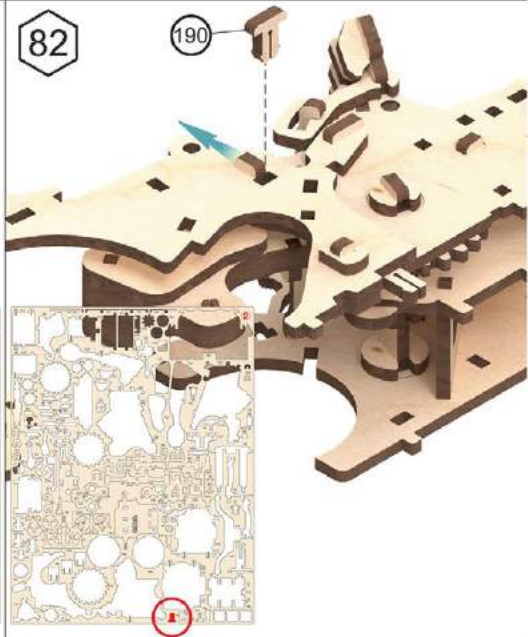
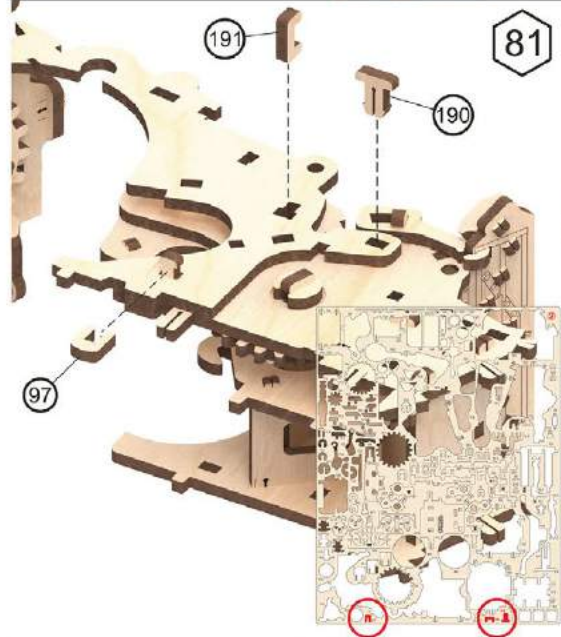
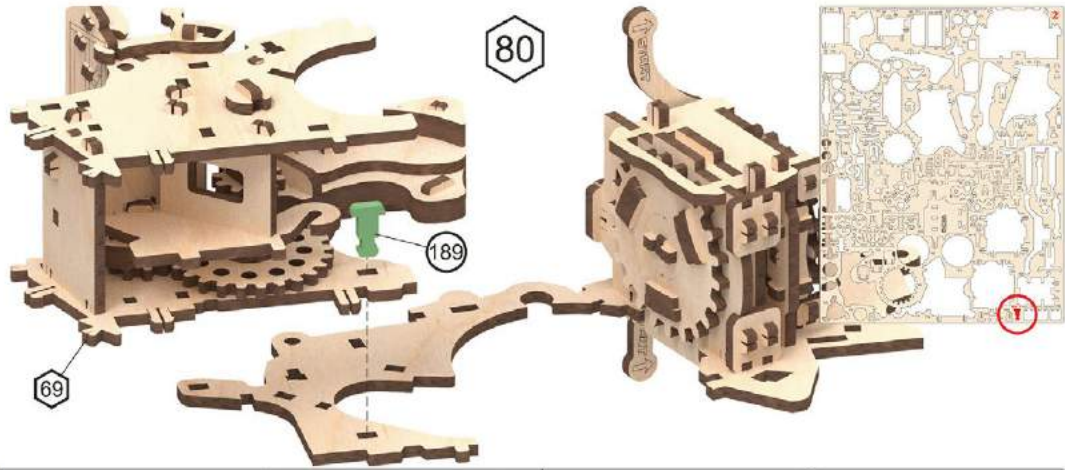



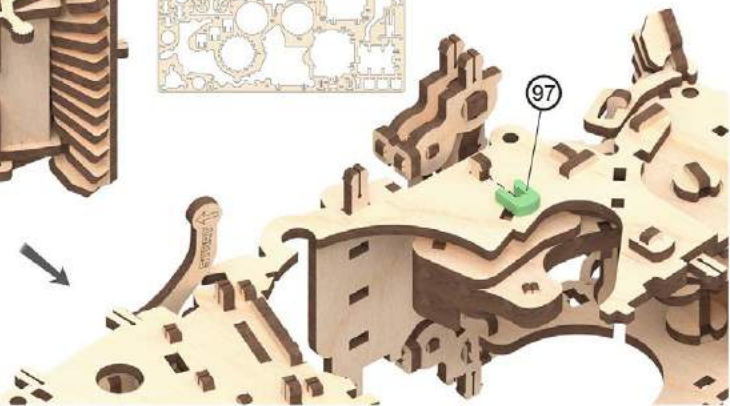
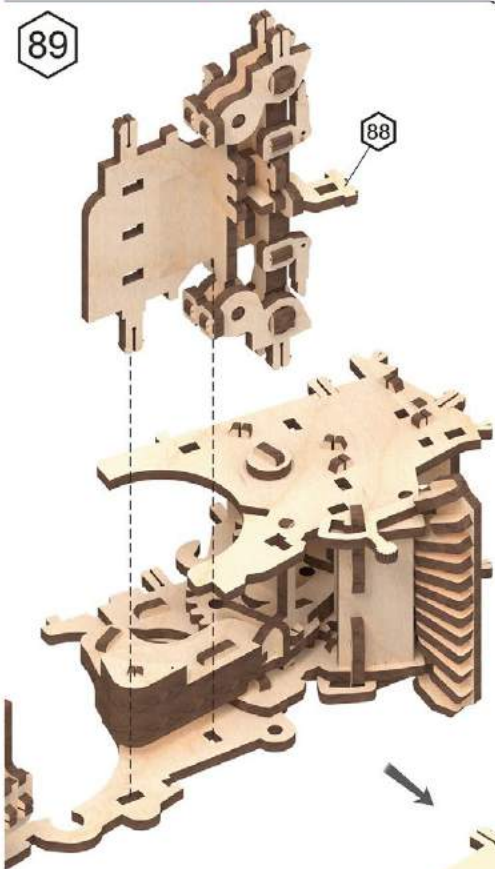
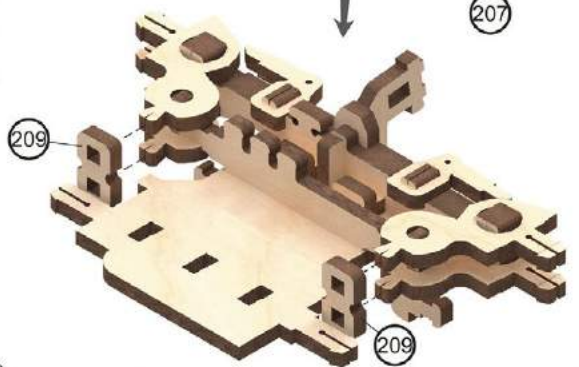
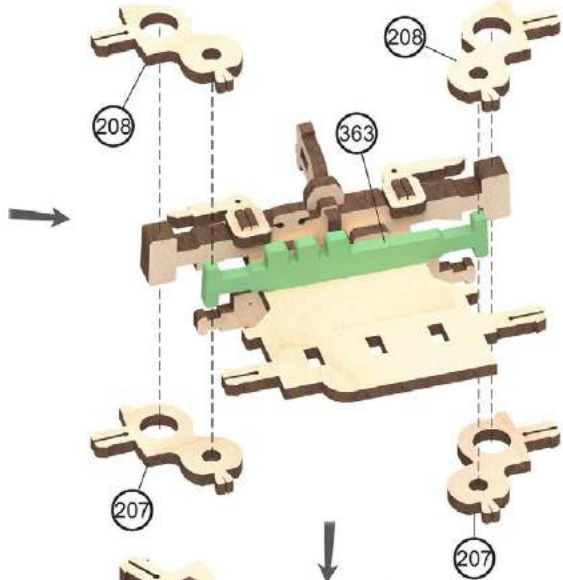
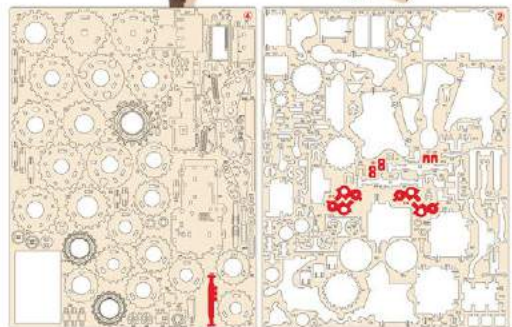
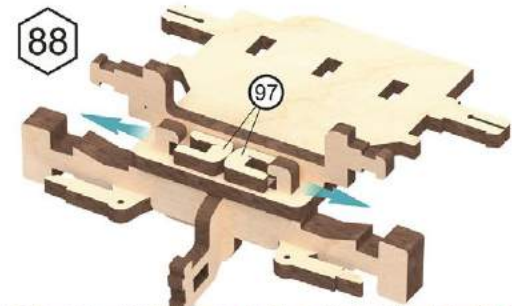



93

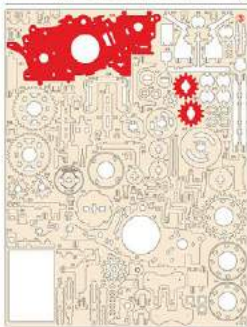
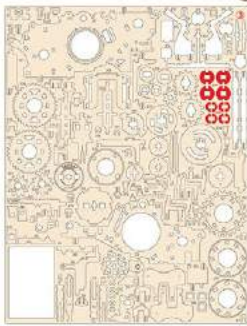
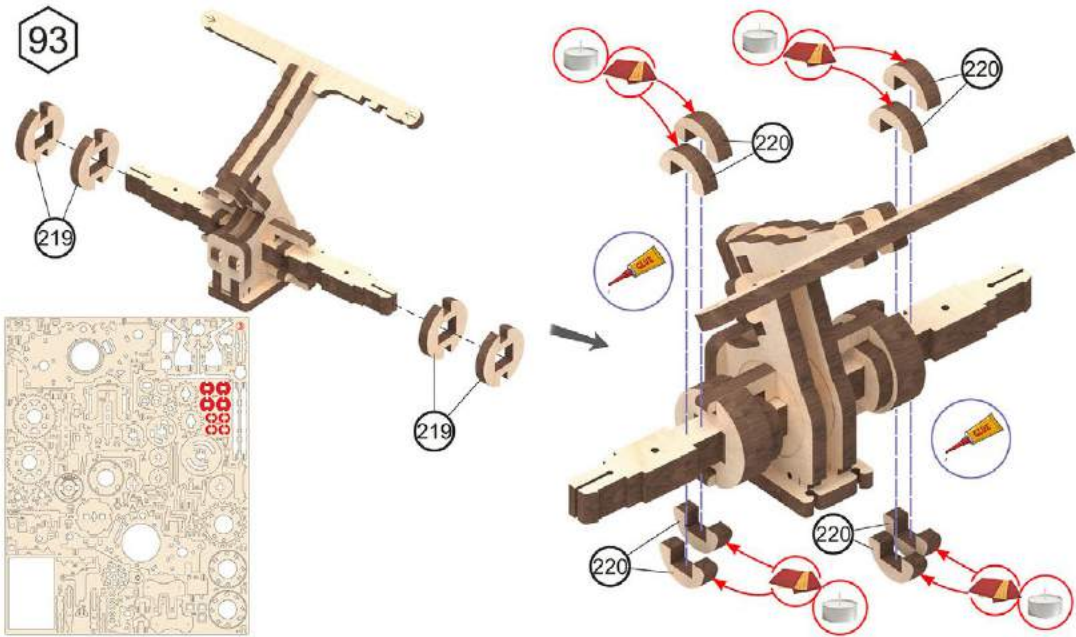

94

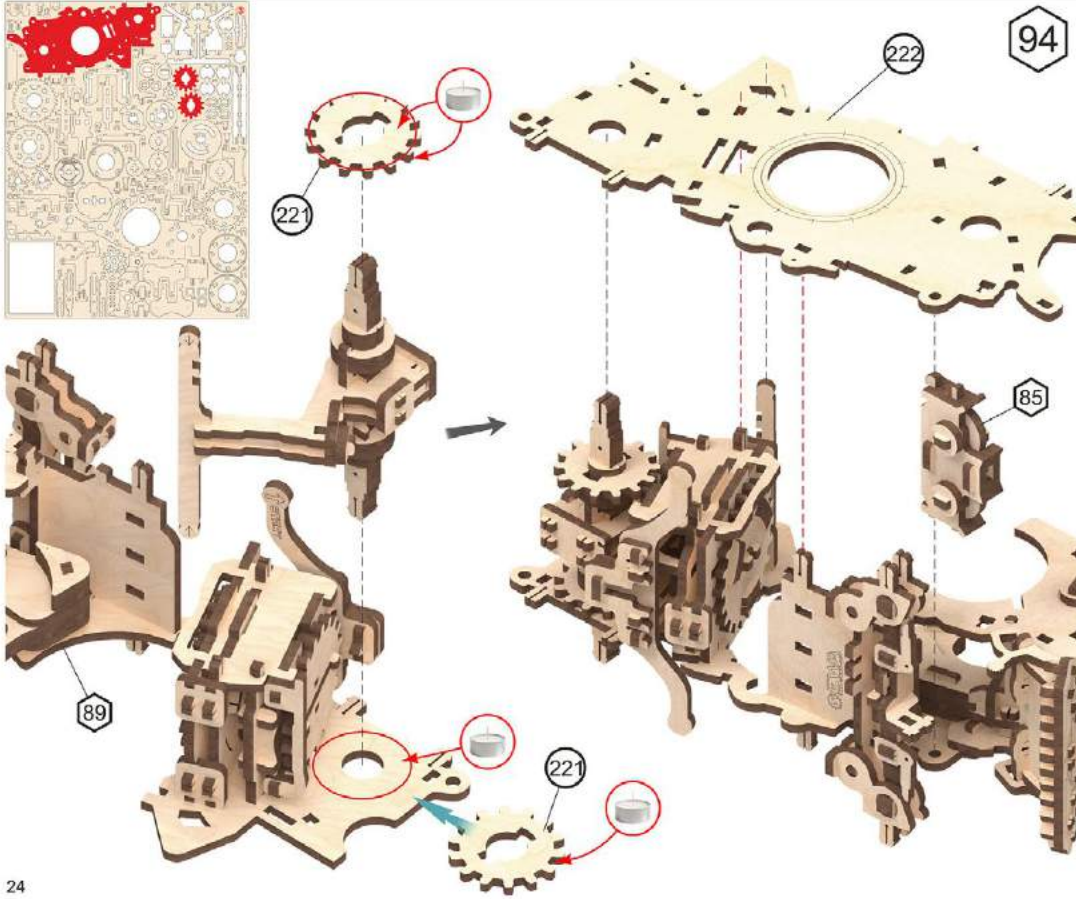

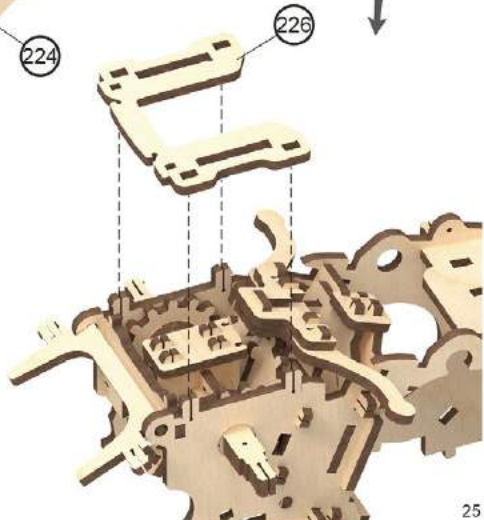
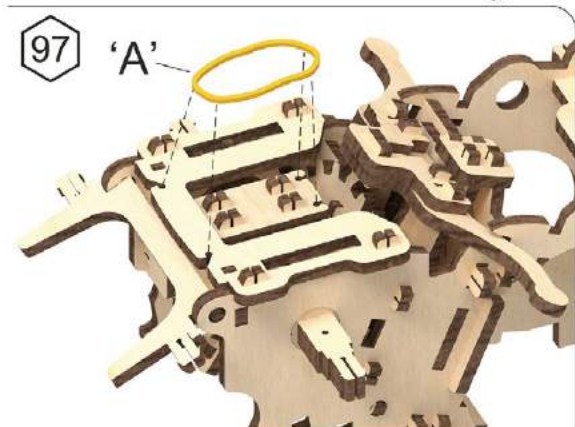
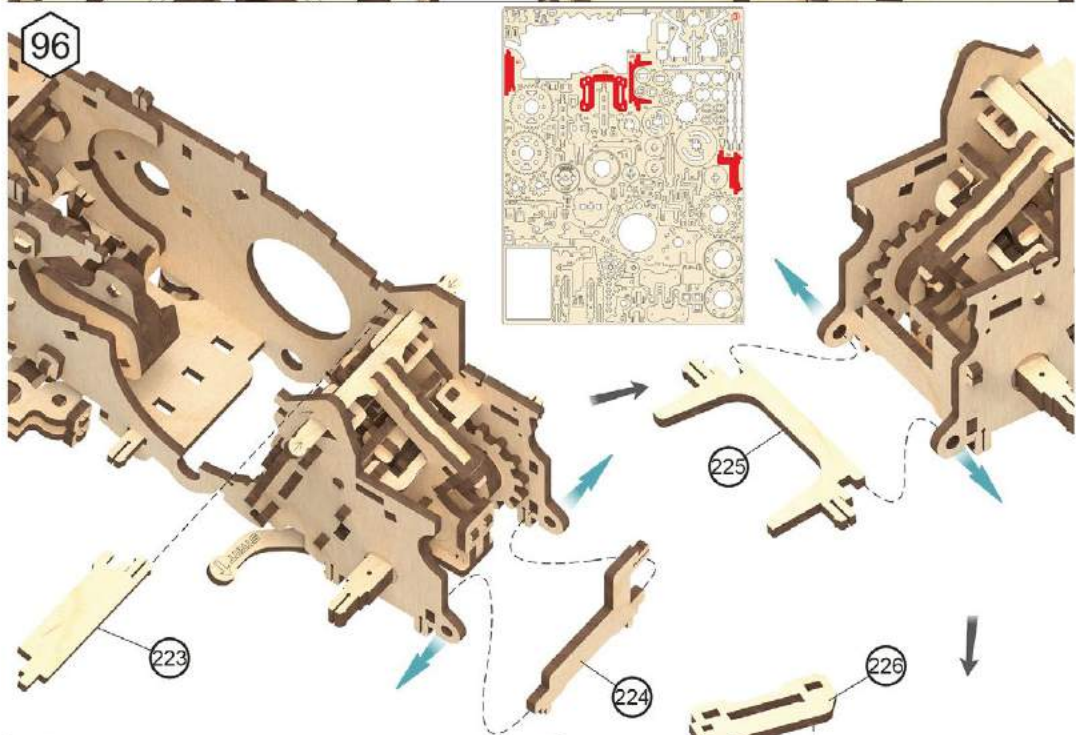
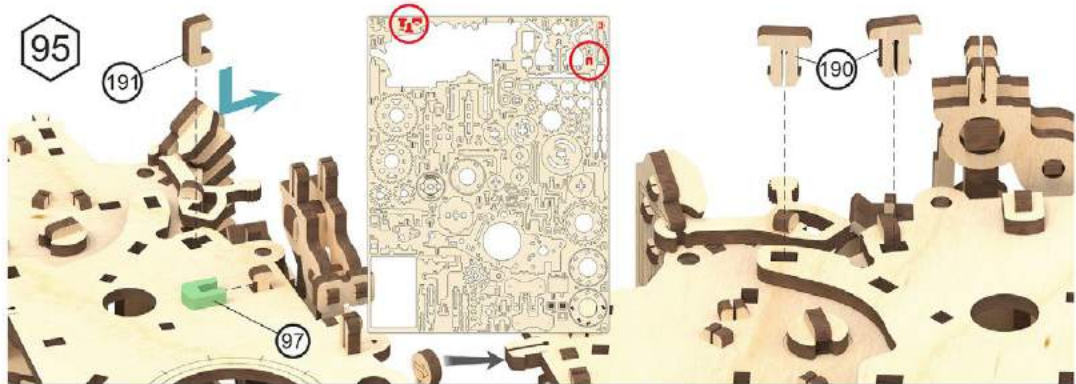



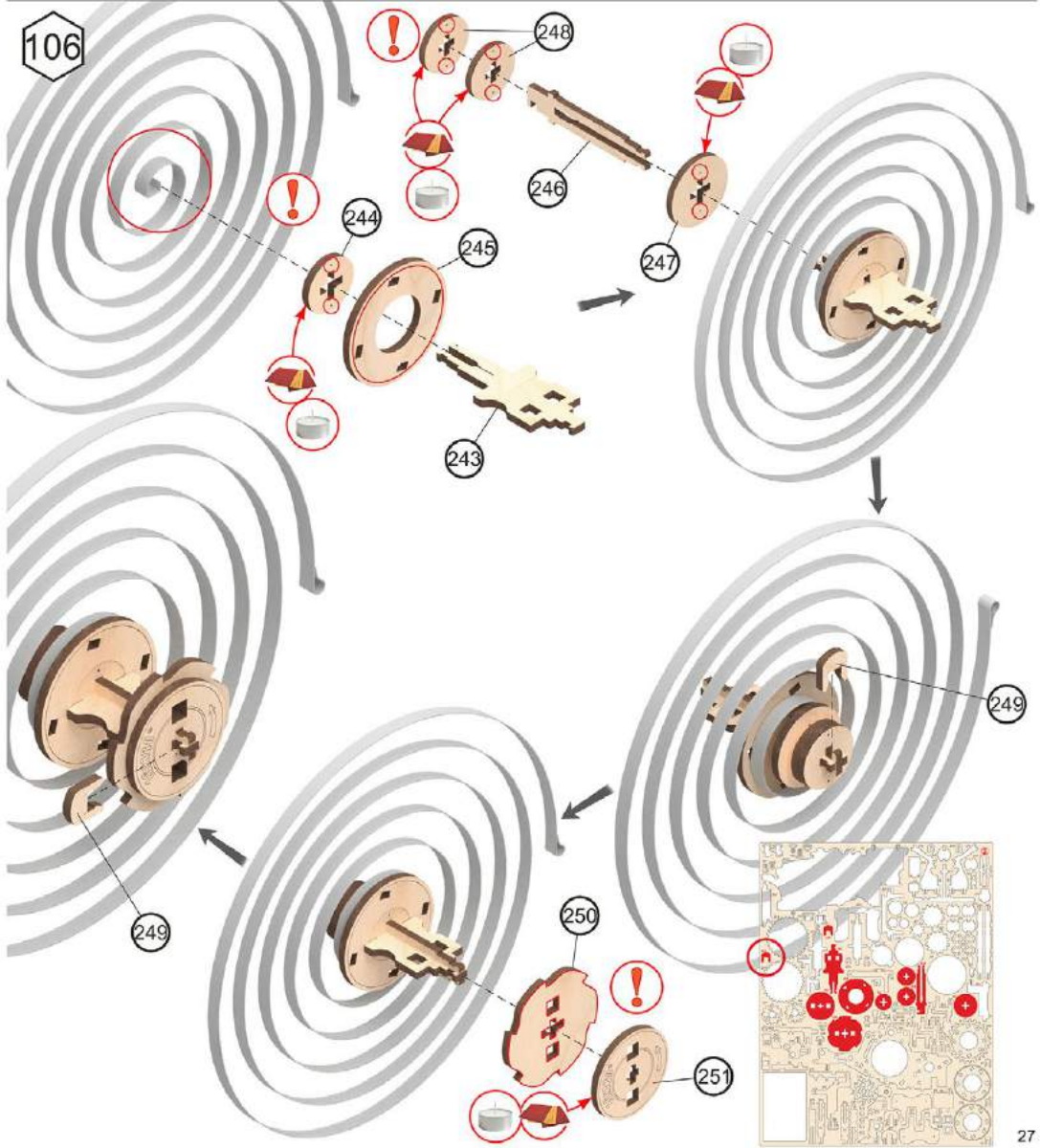
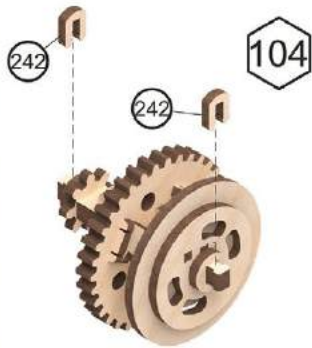
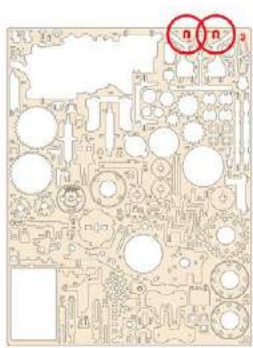

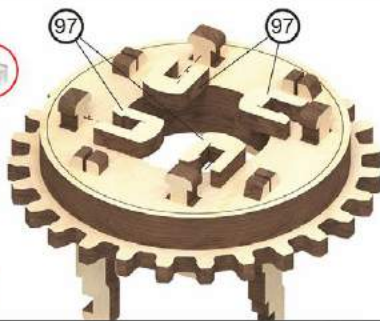
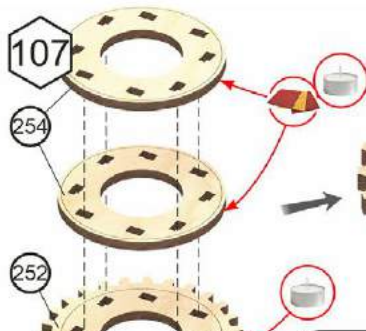

108

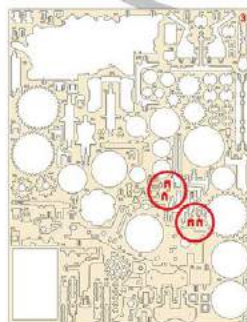
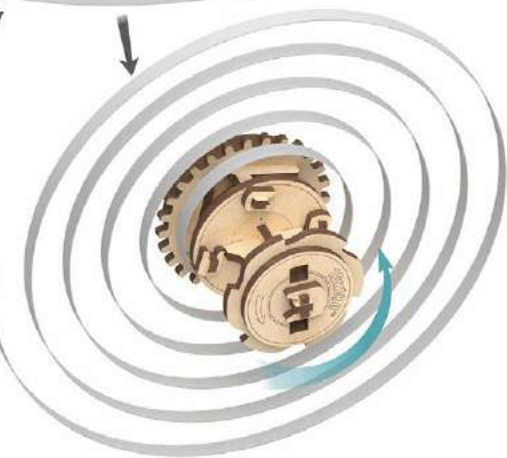

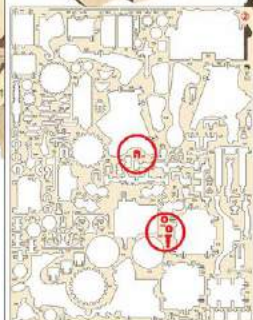
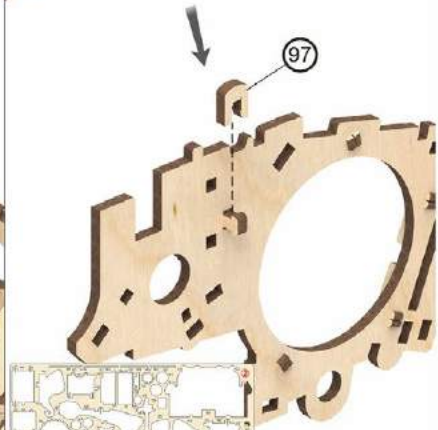
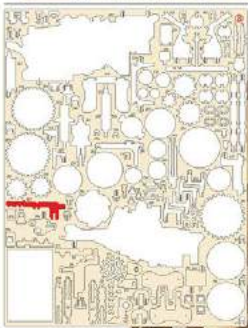
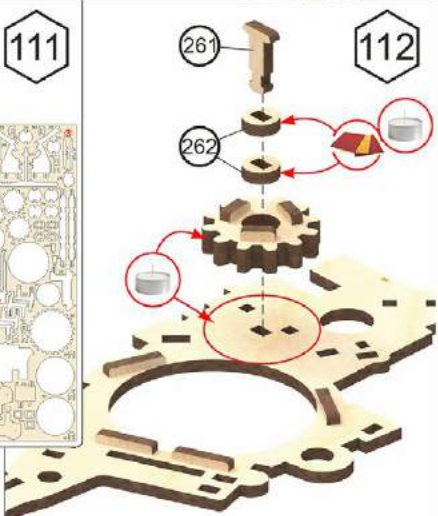
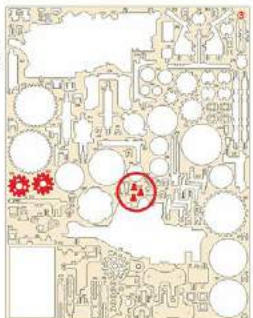
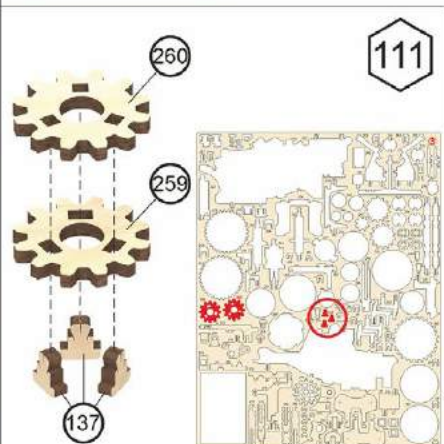
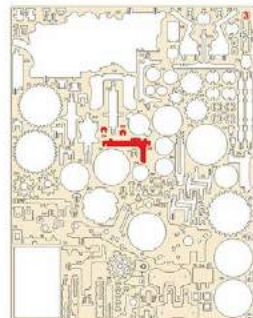
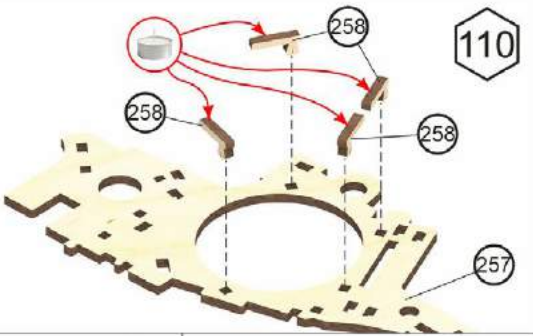
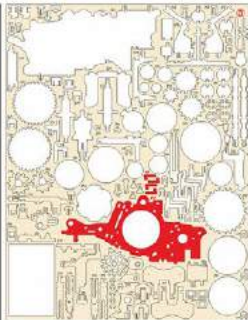
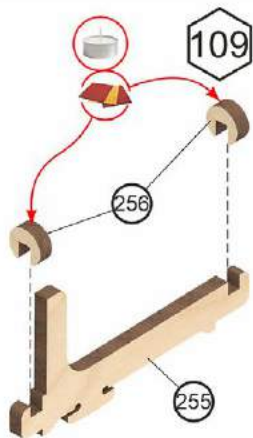

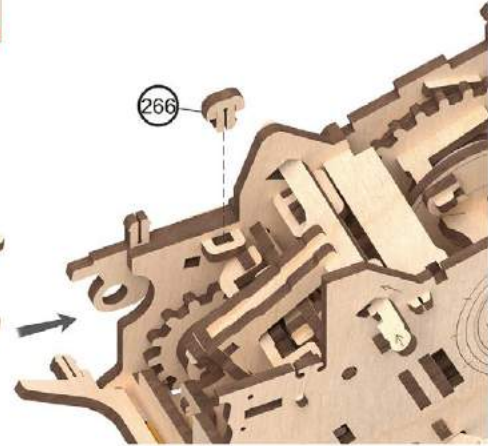
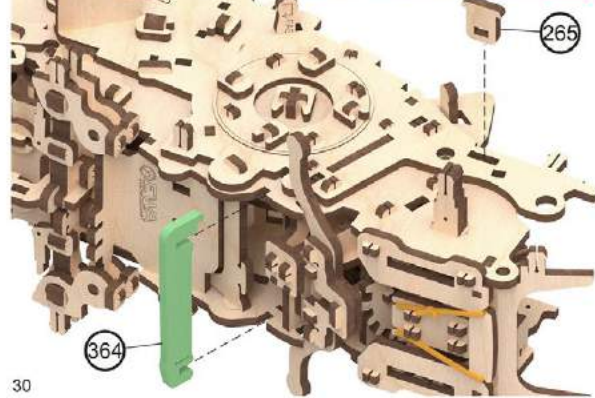
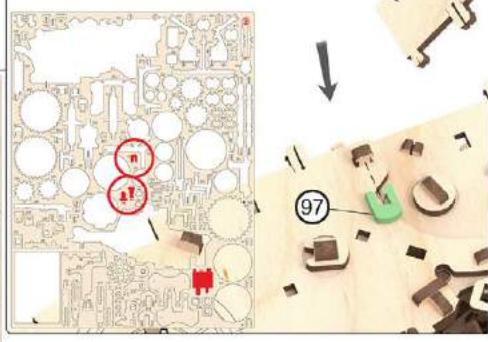
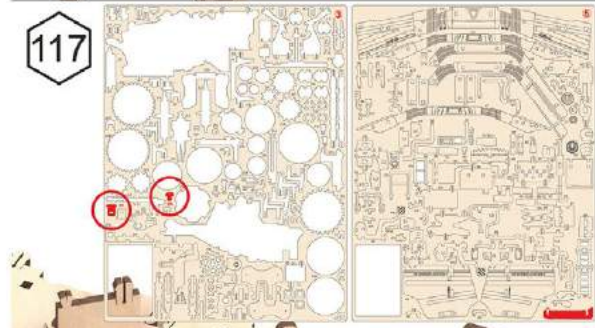
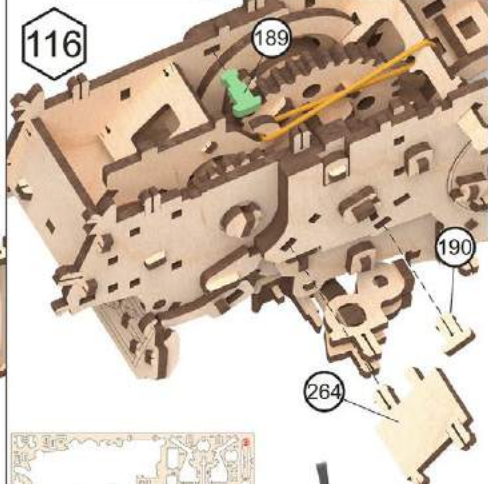
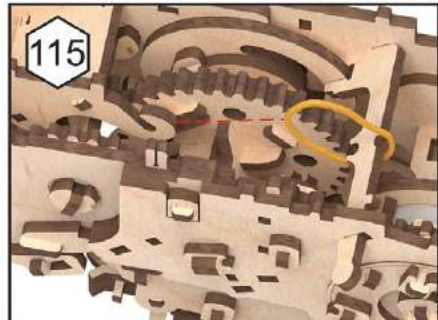
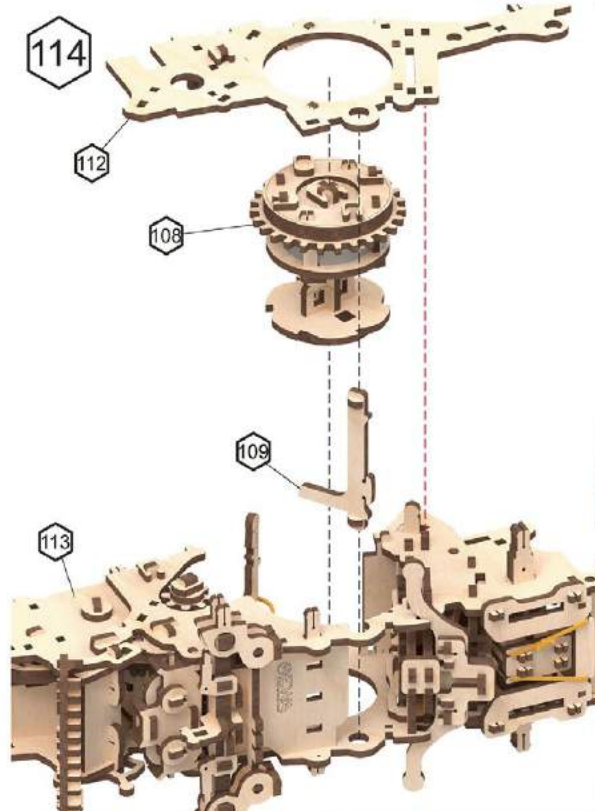

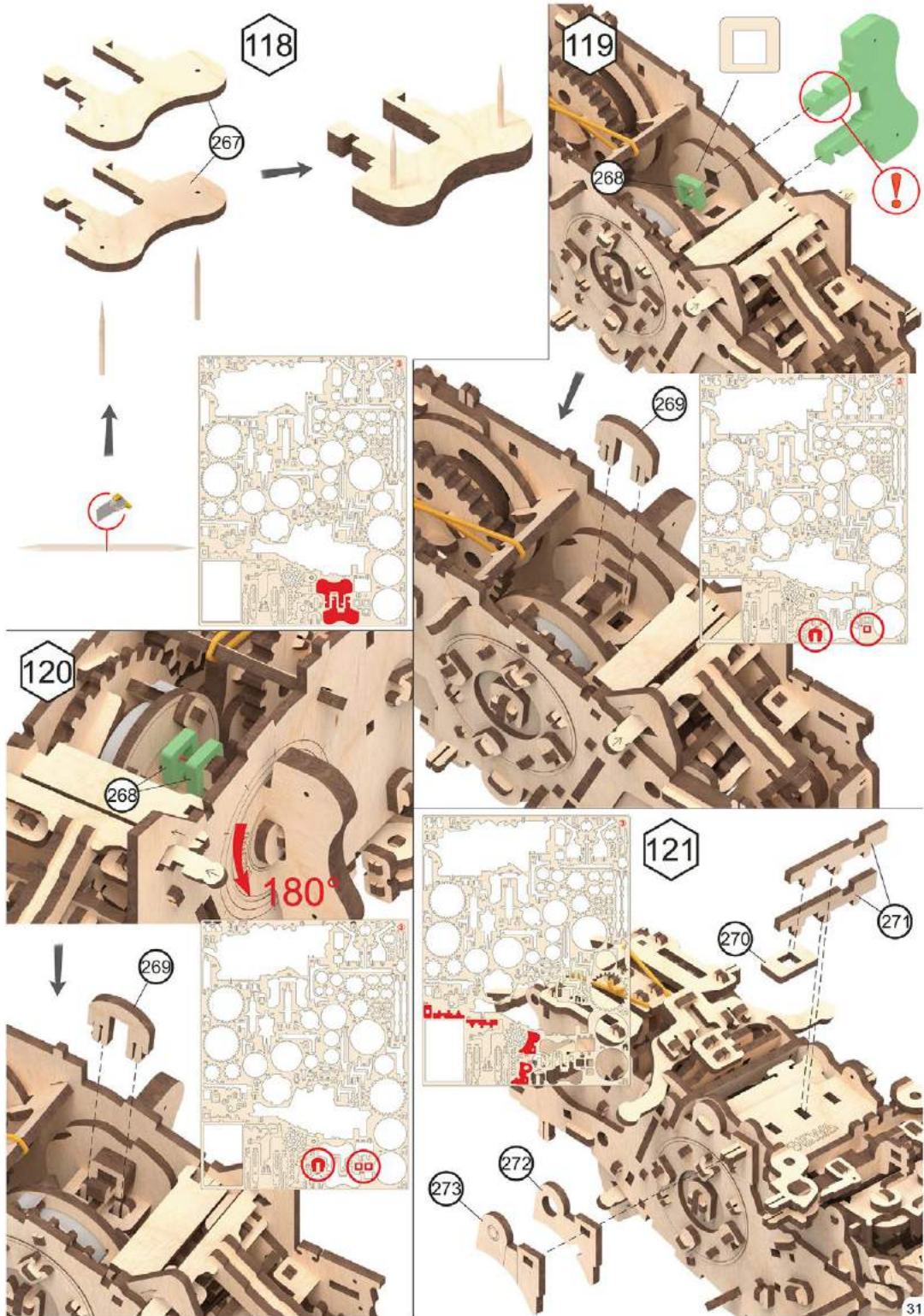

122

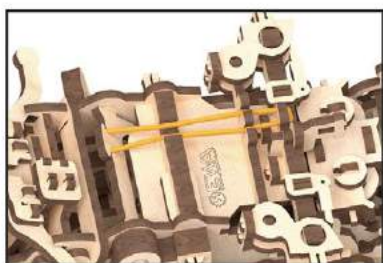
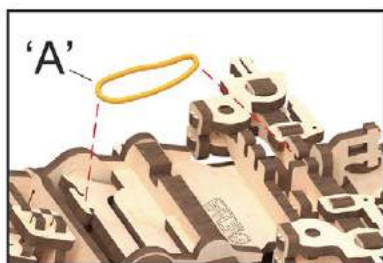

123

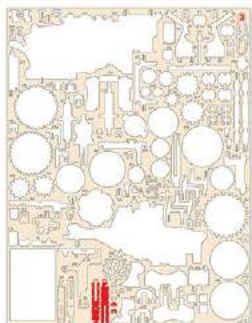
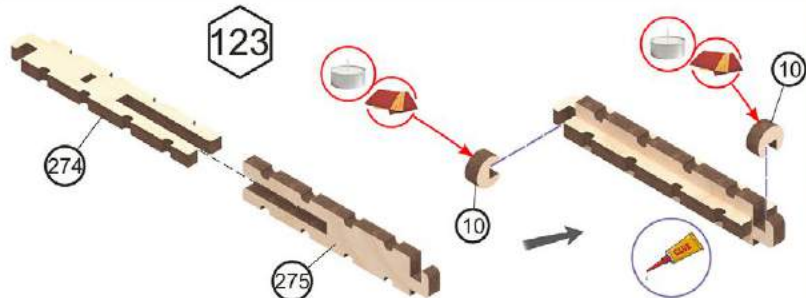

124

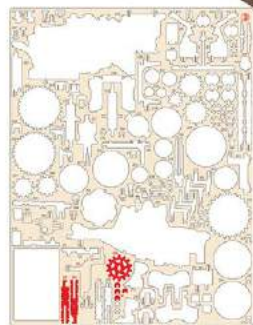
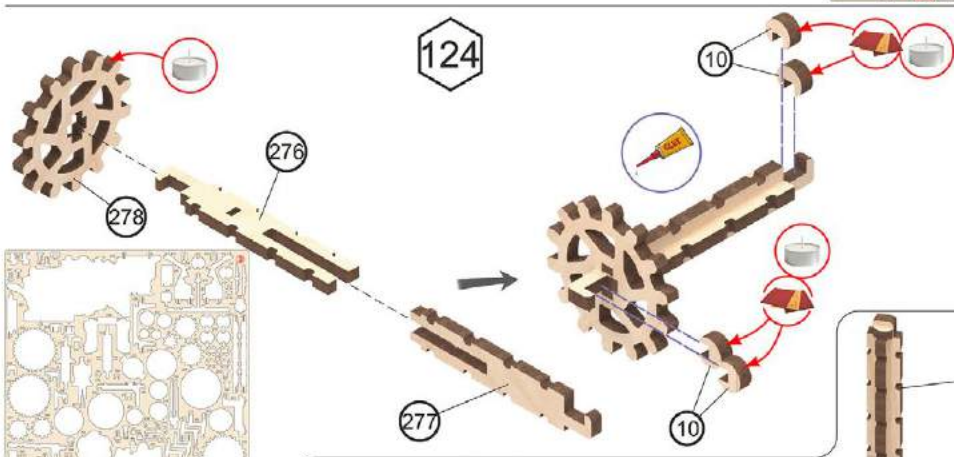

125

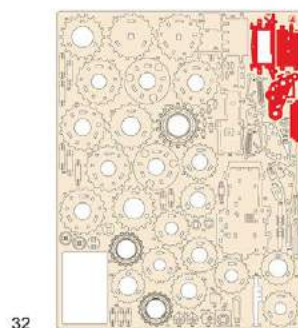
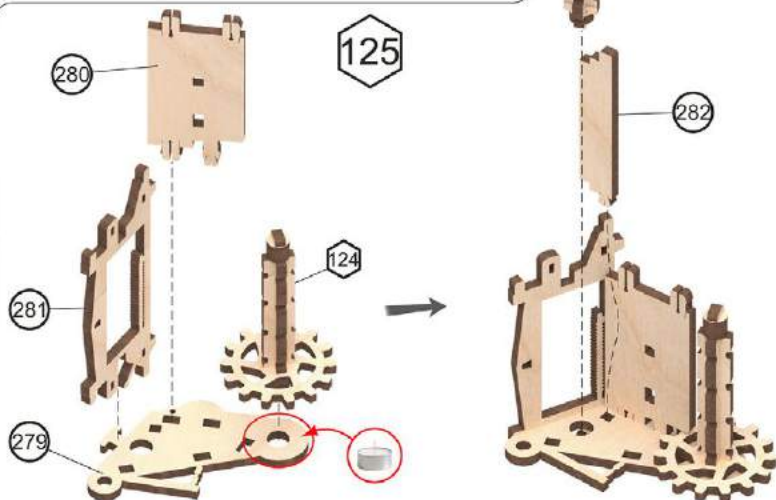

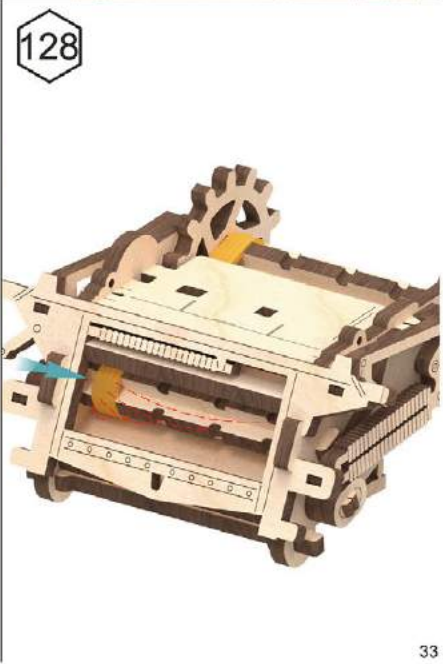
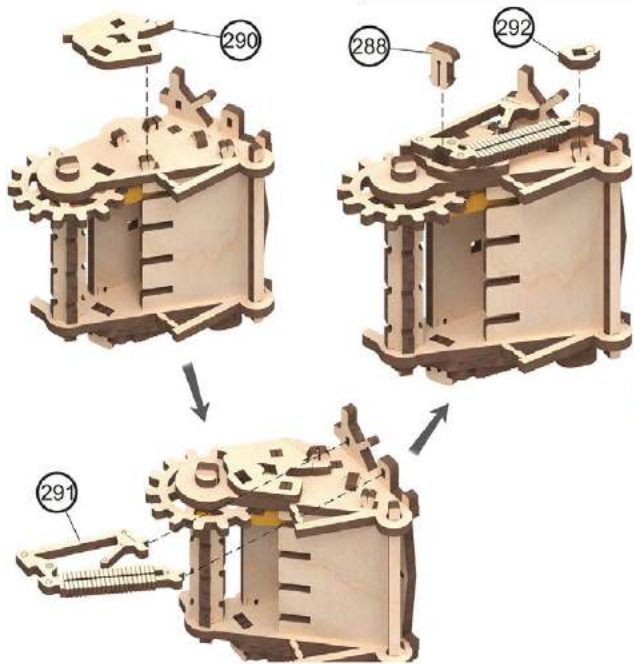
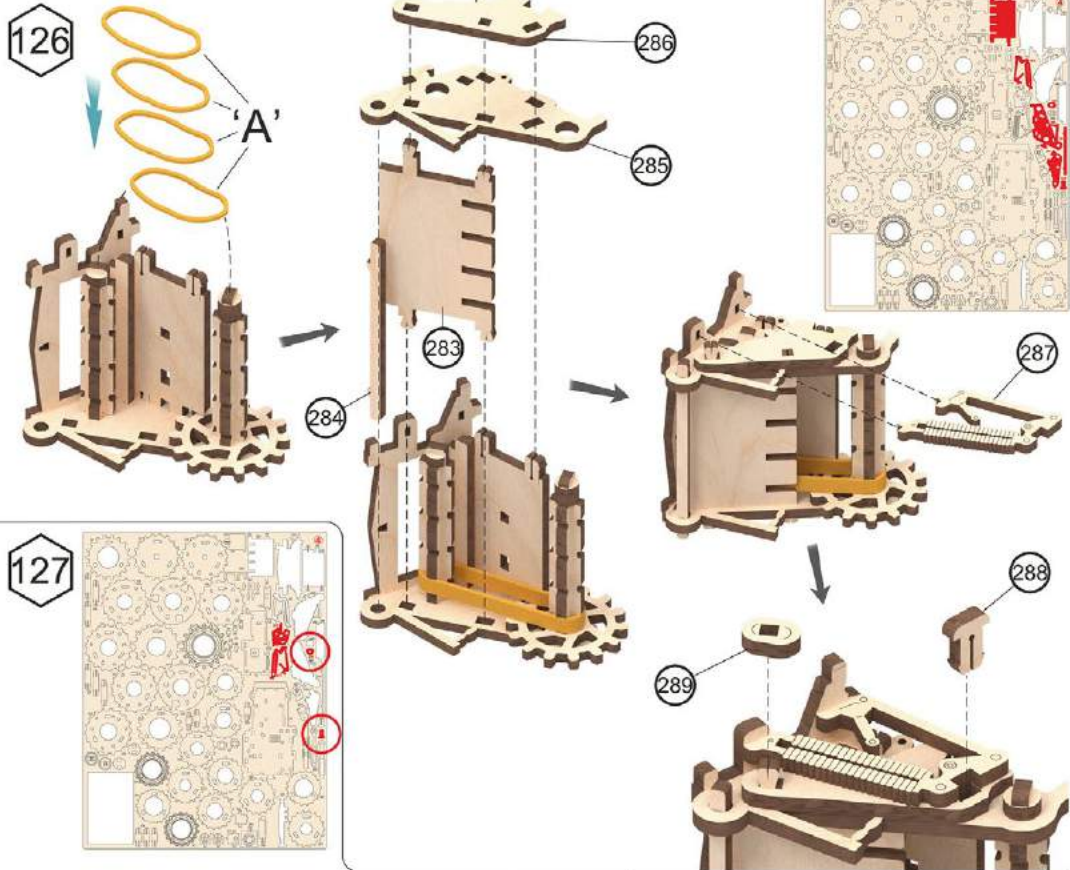

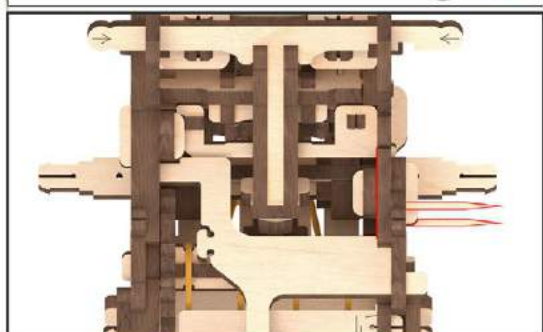
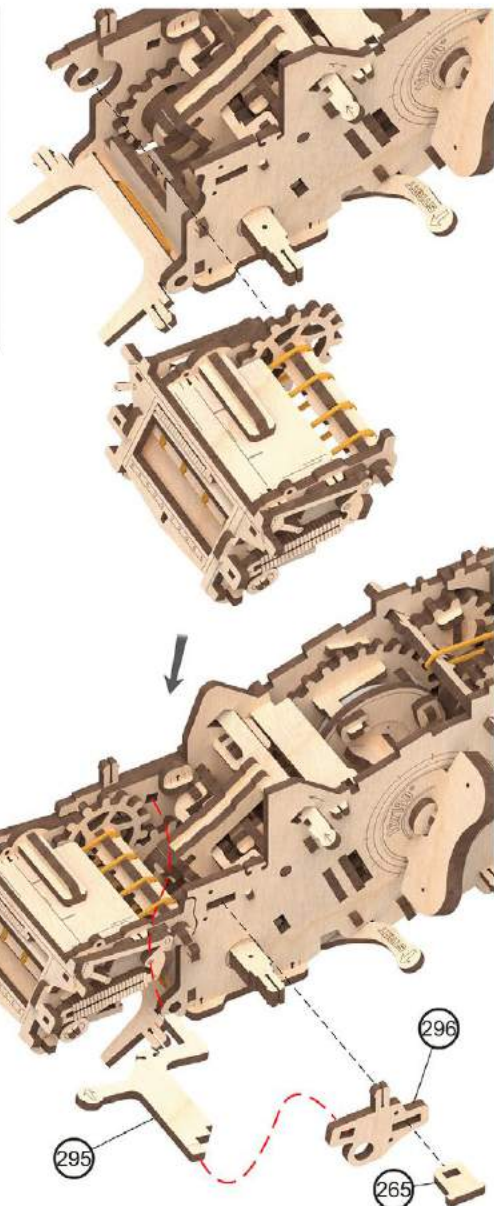
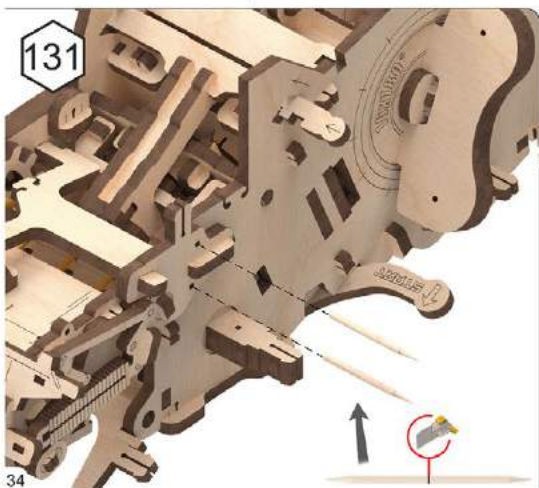
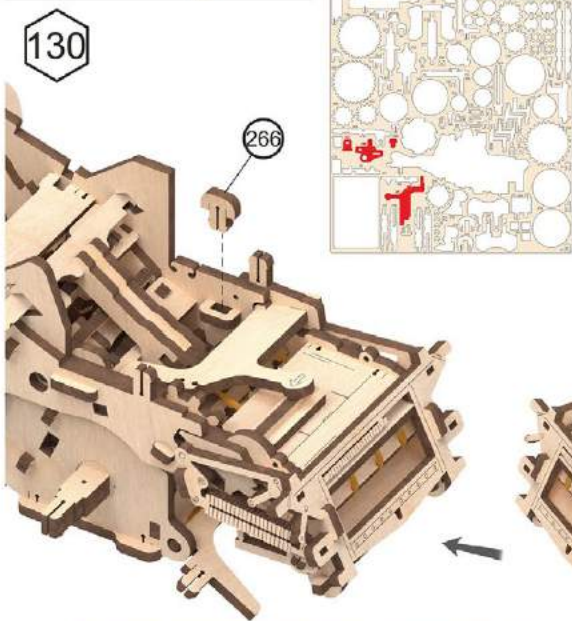
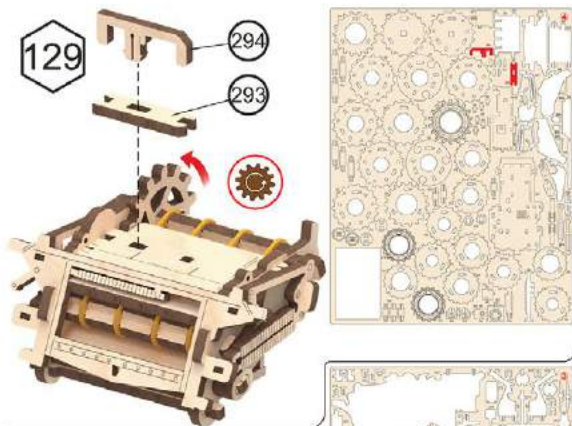

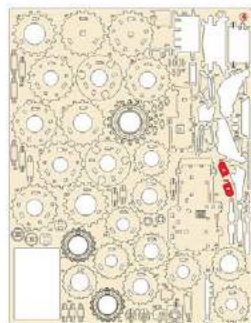
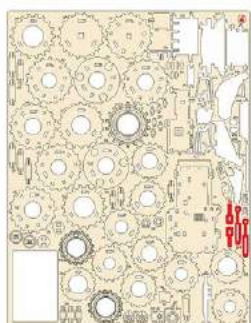
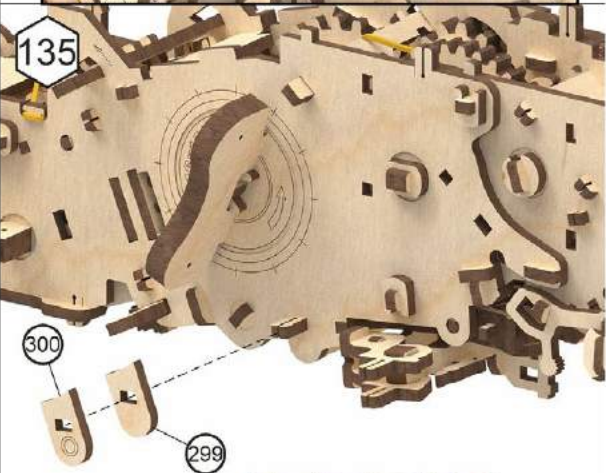
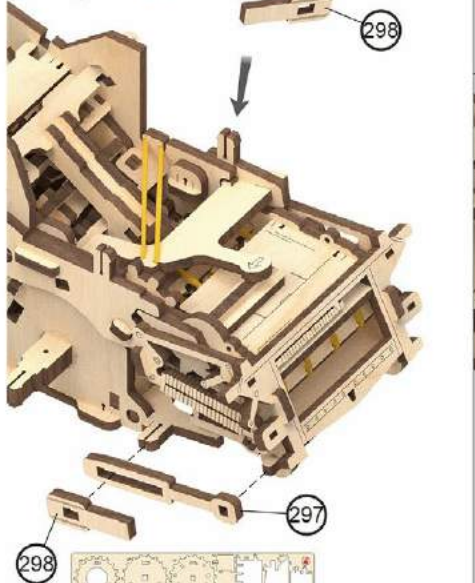
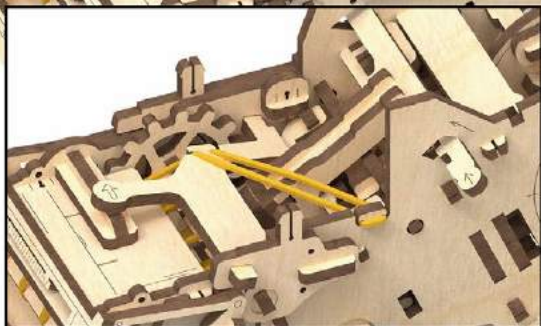
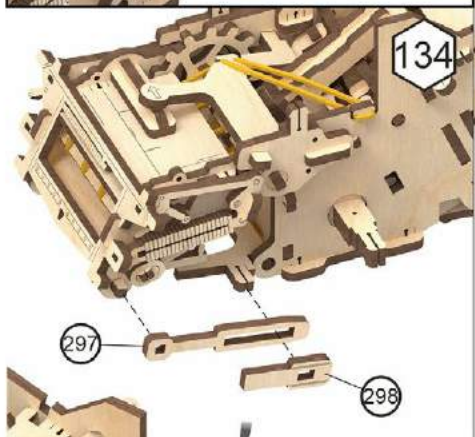
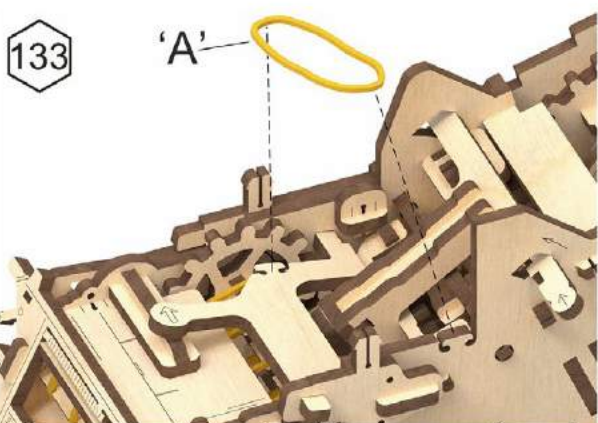
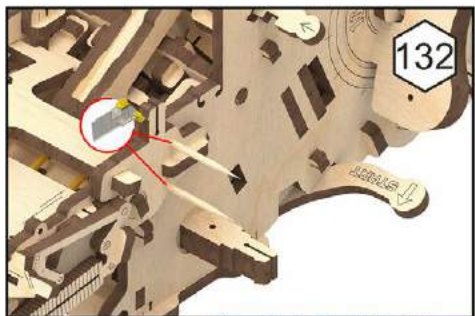

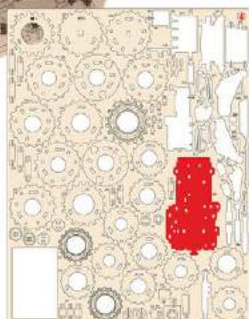
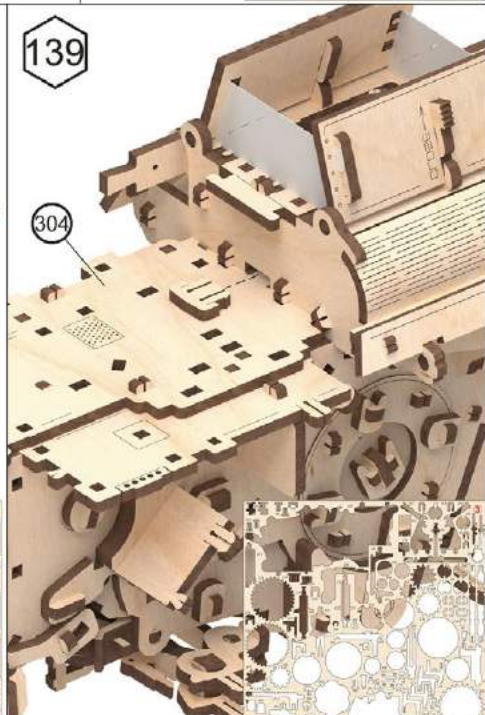
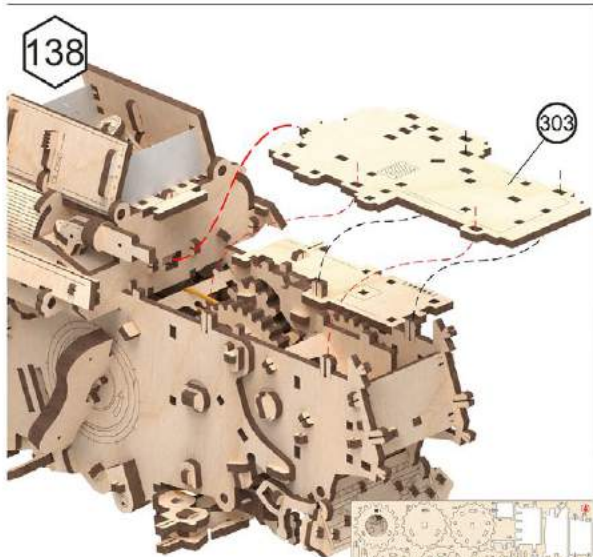
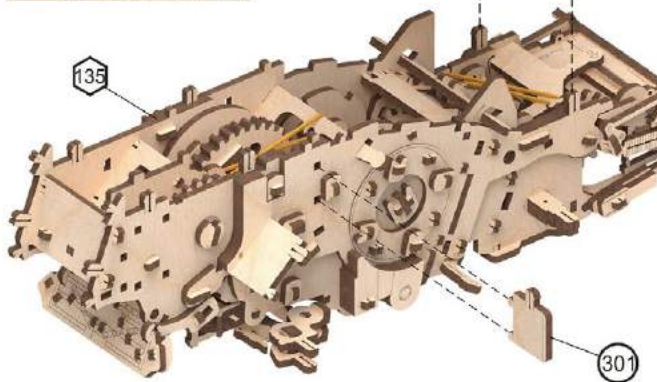
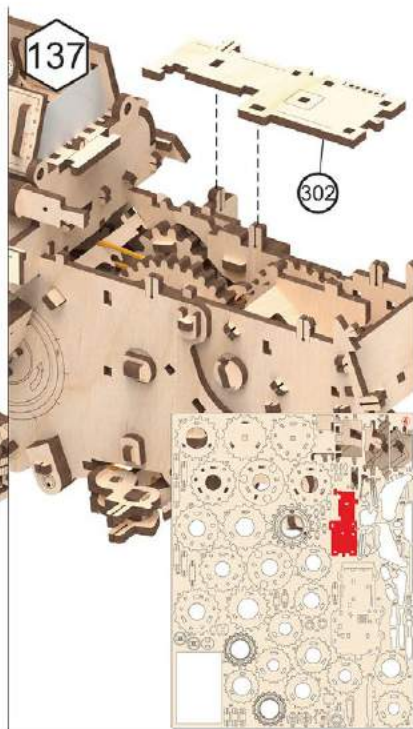
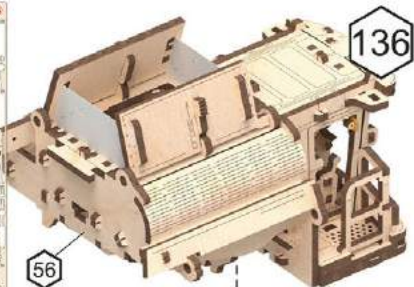
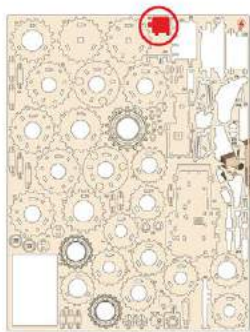

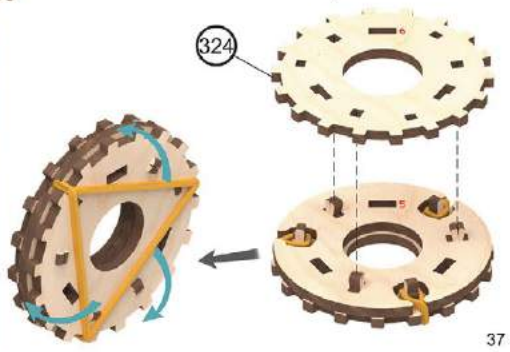
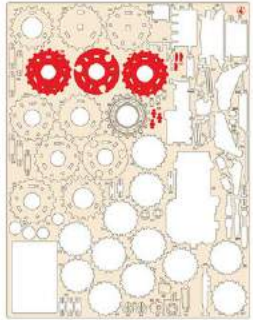
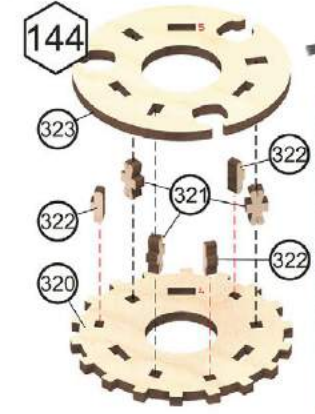
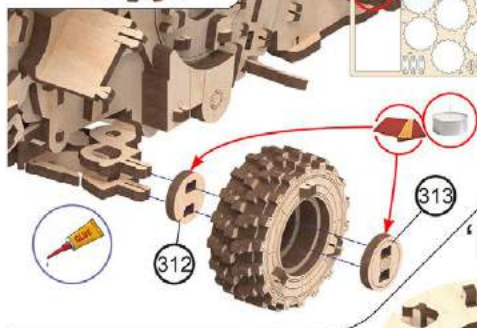
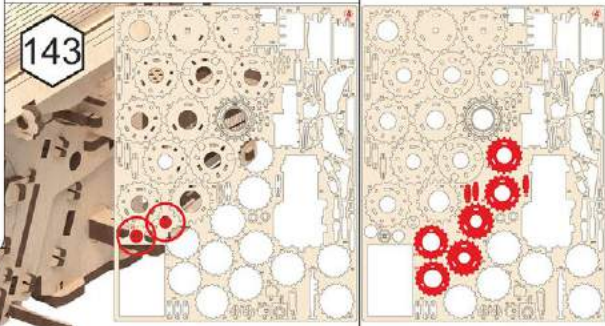
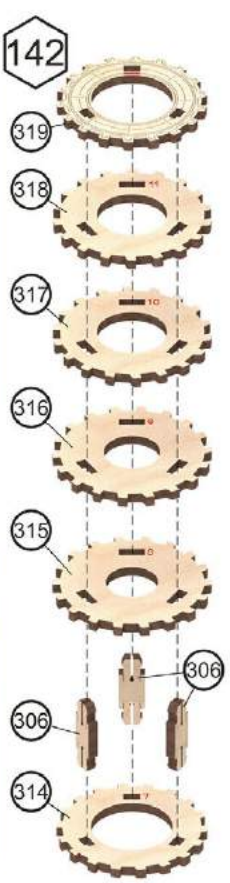
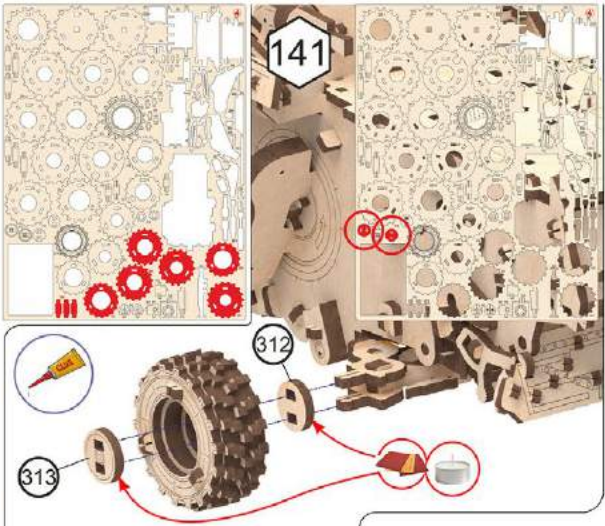
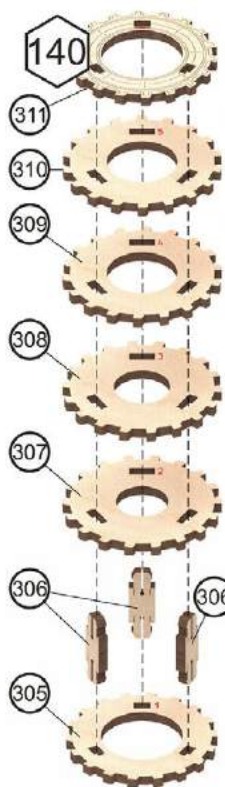

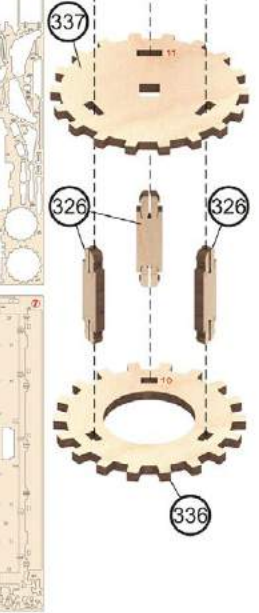
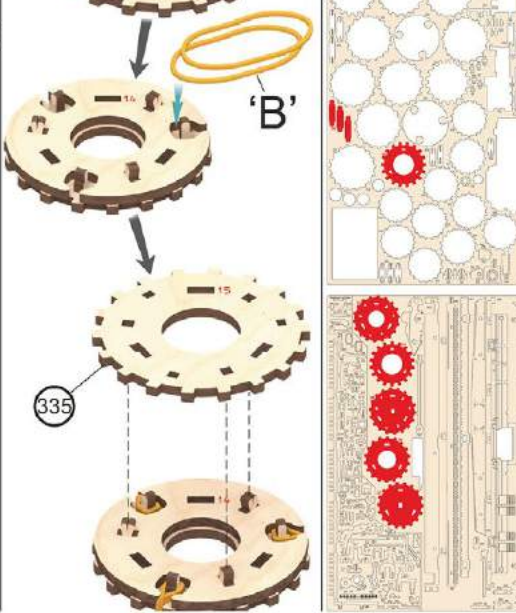
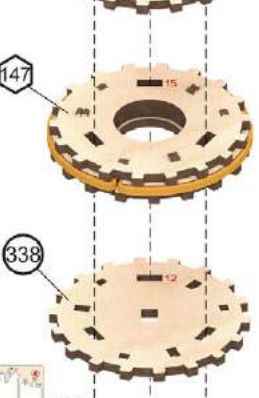
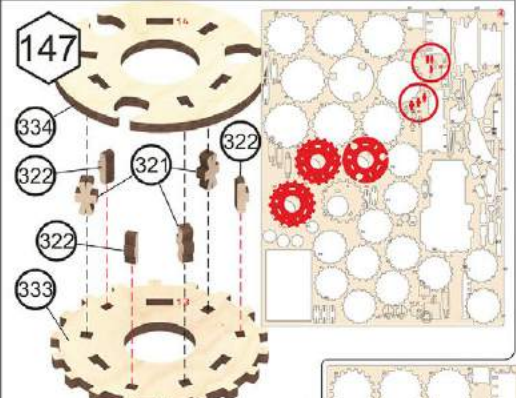
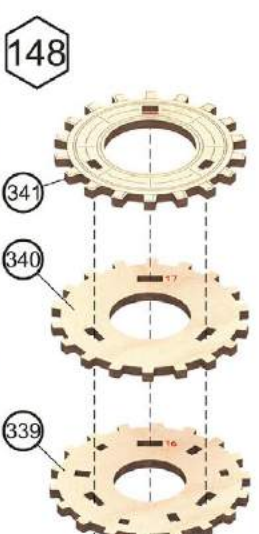
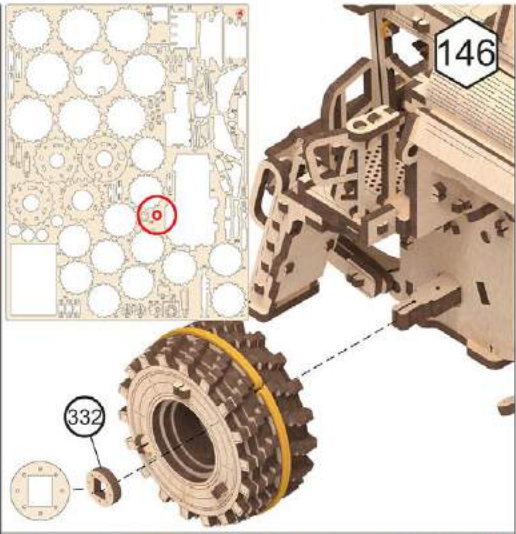
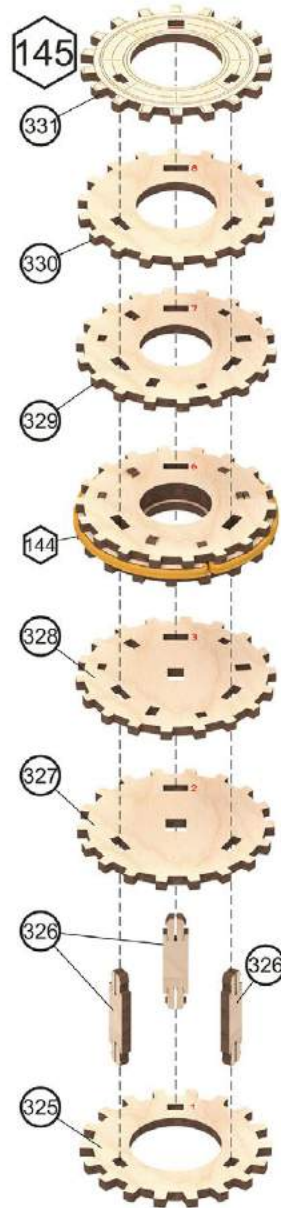

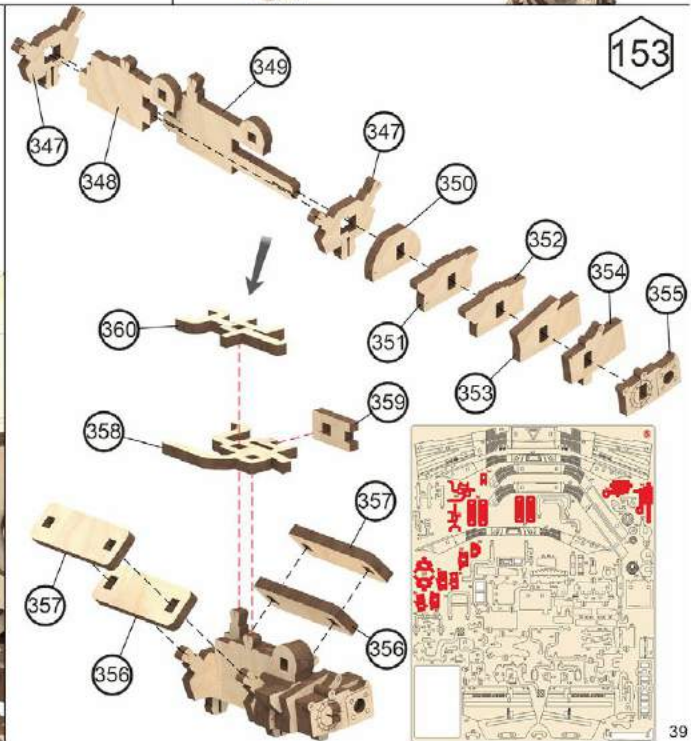
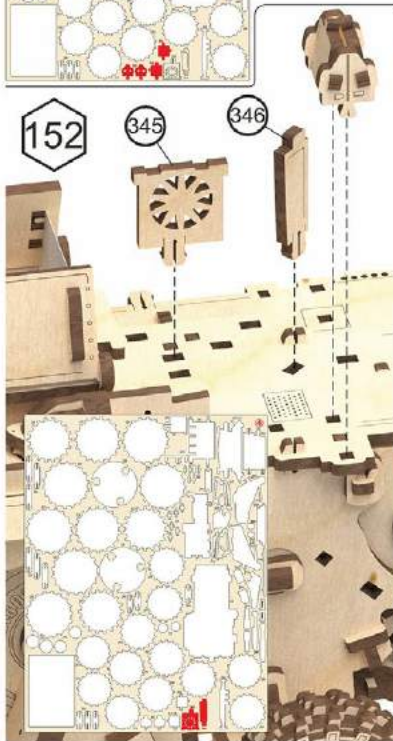
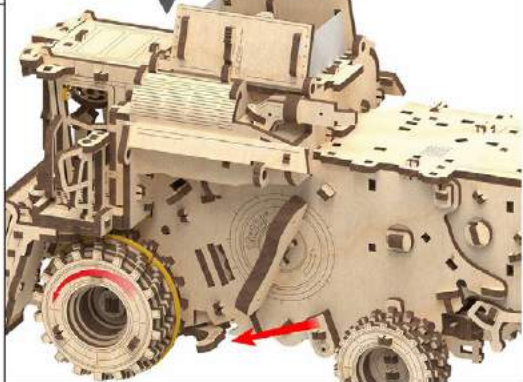
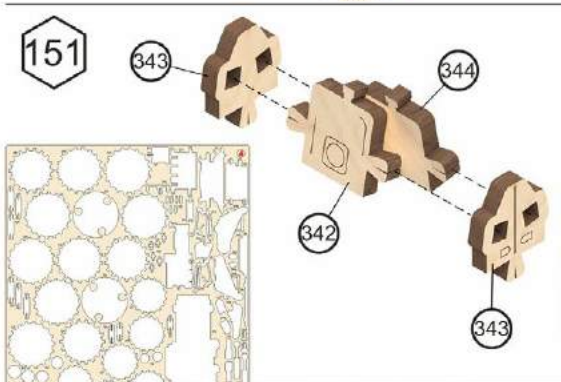
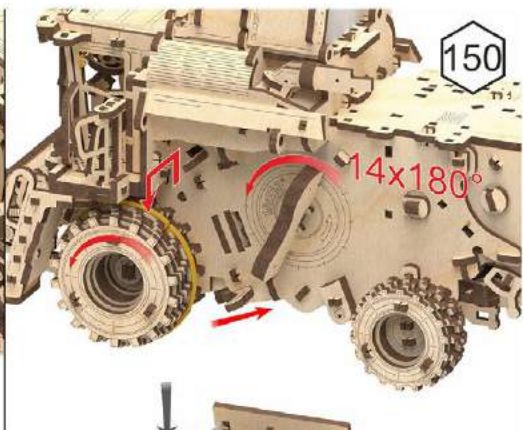
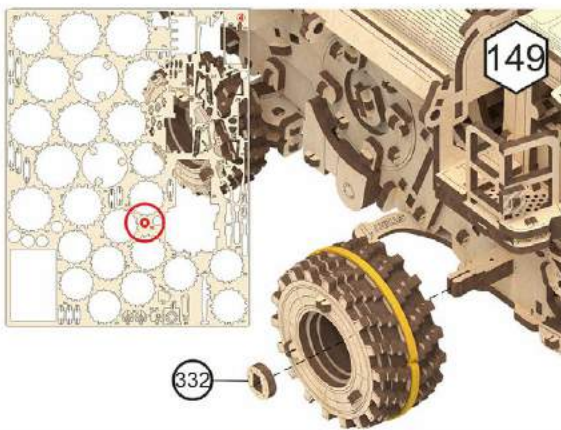

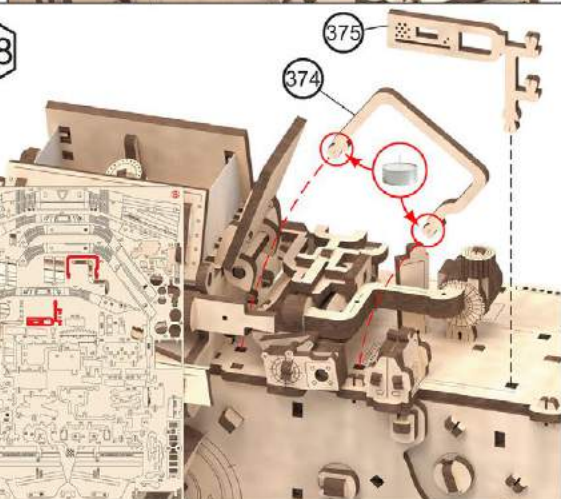
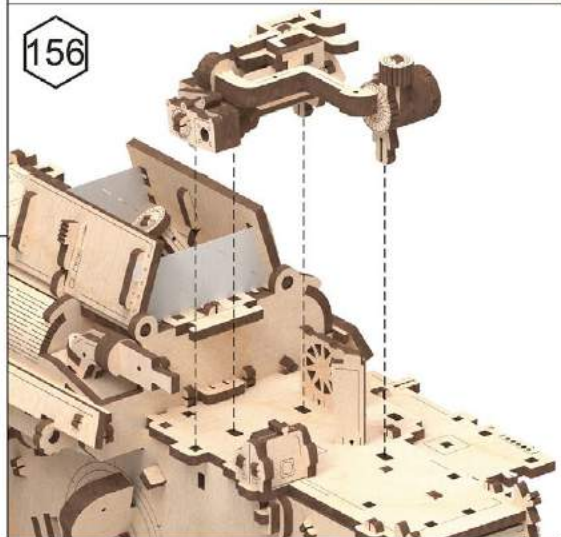
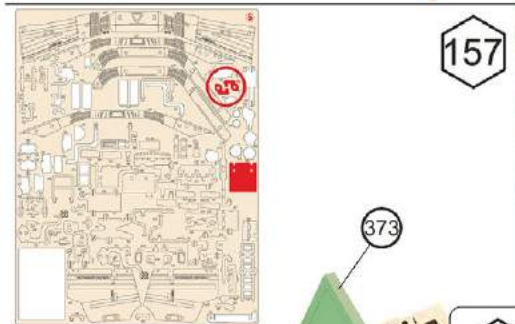
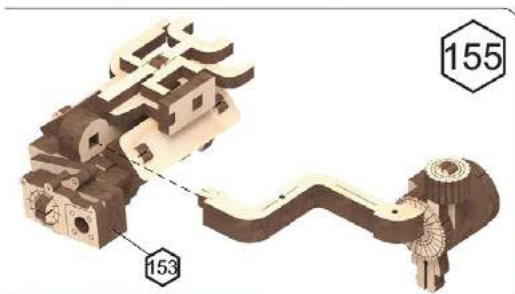
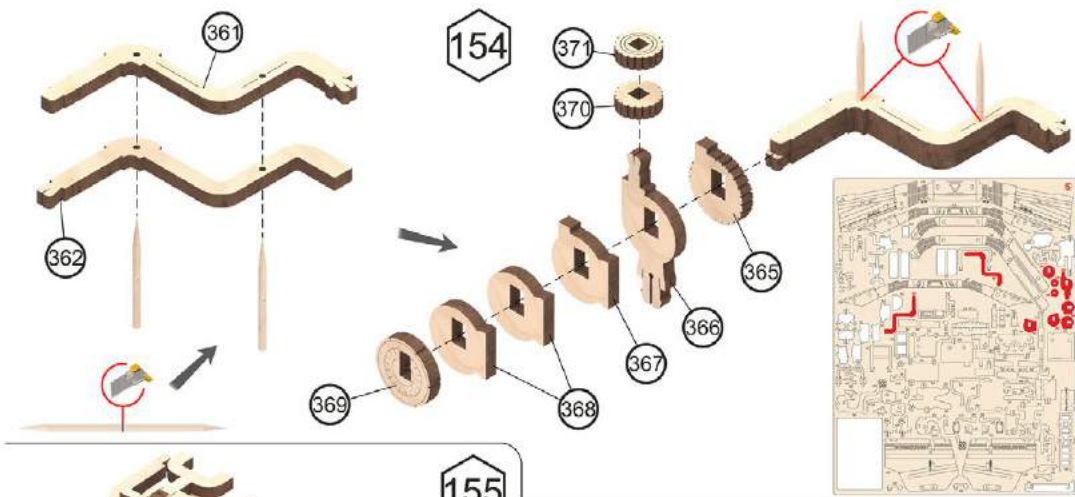

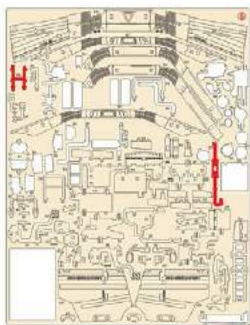

159



160

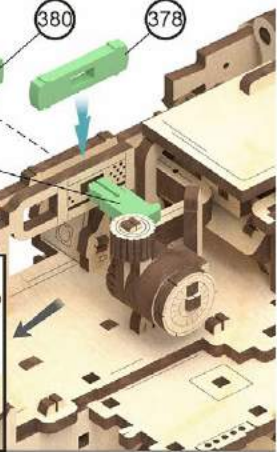
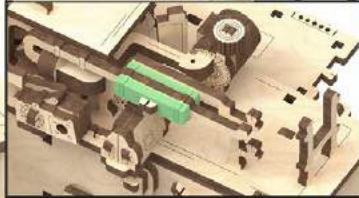
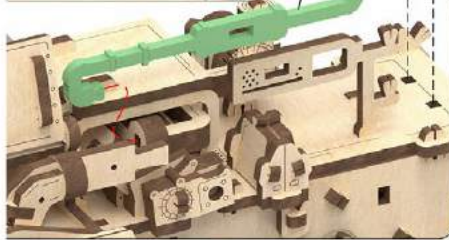

161

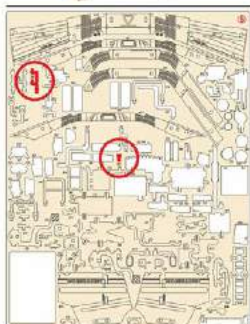
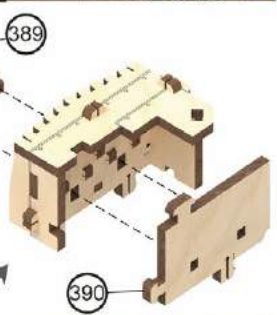
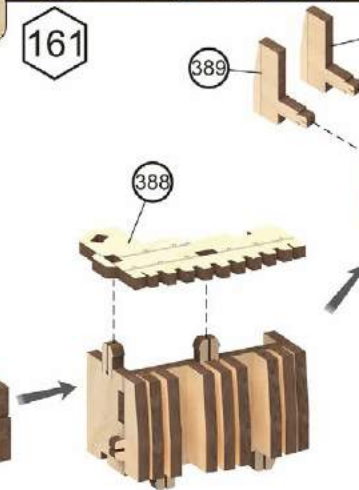
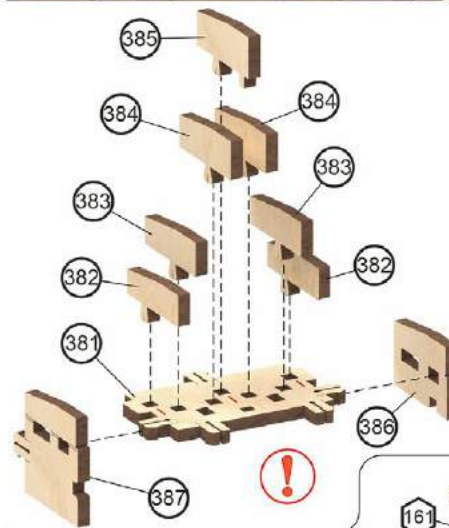

161

162

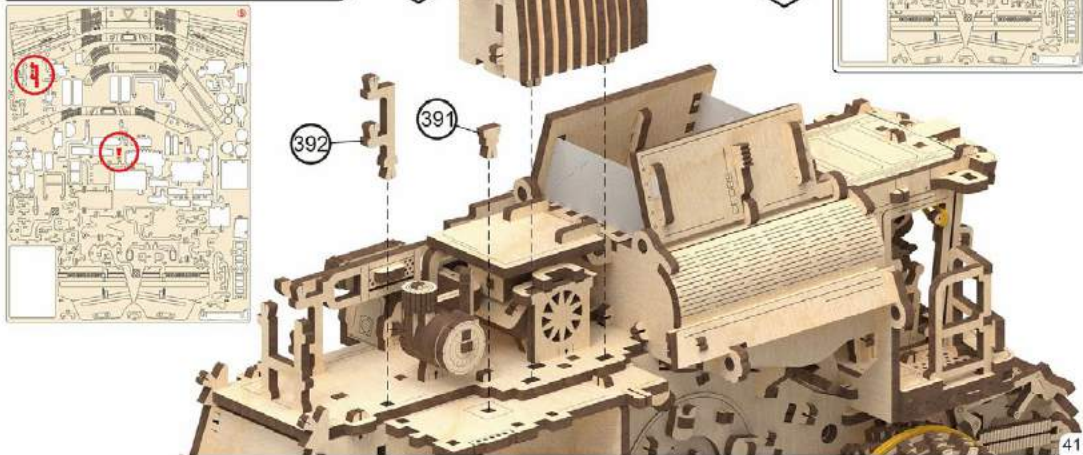
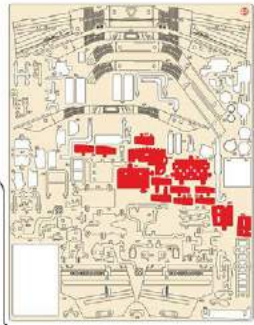

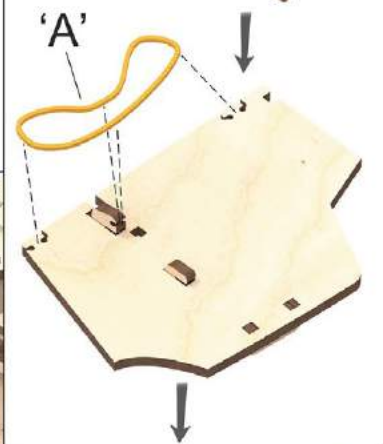
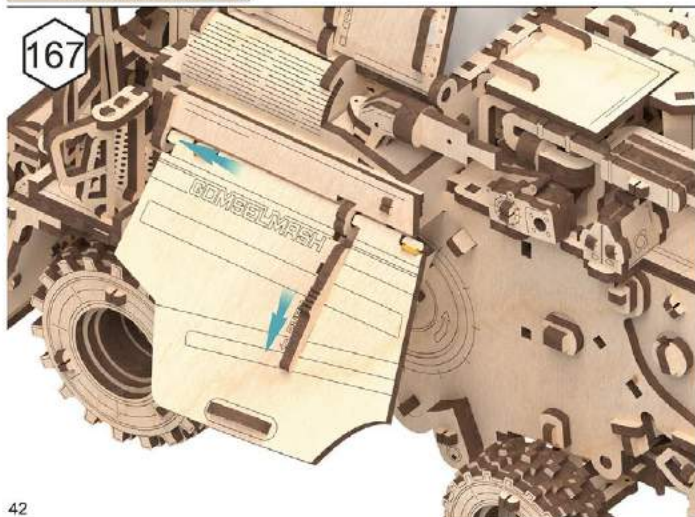
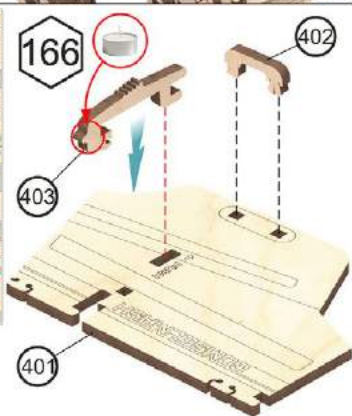
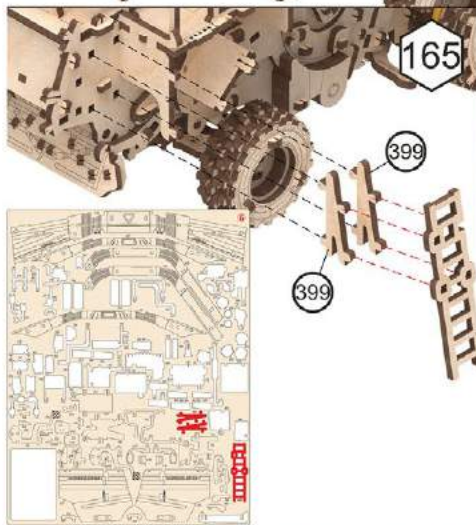
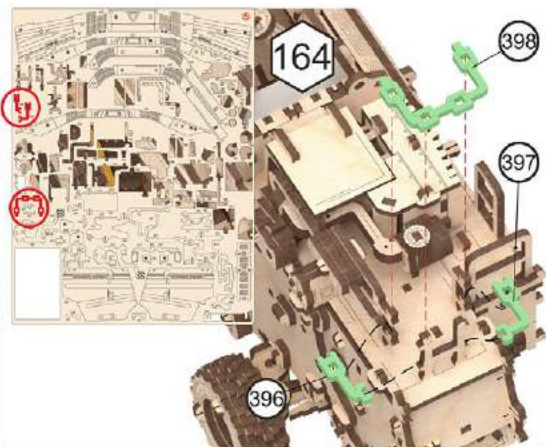
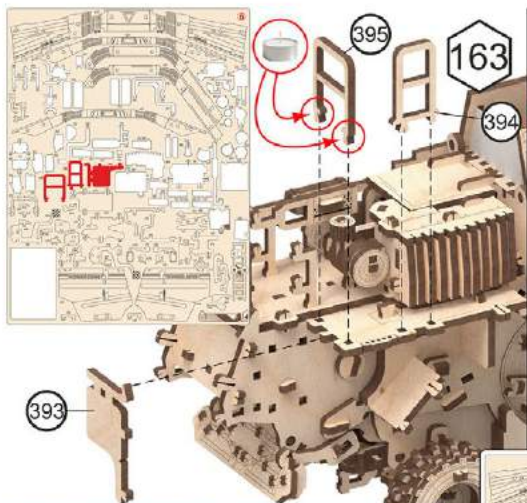

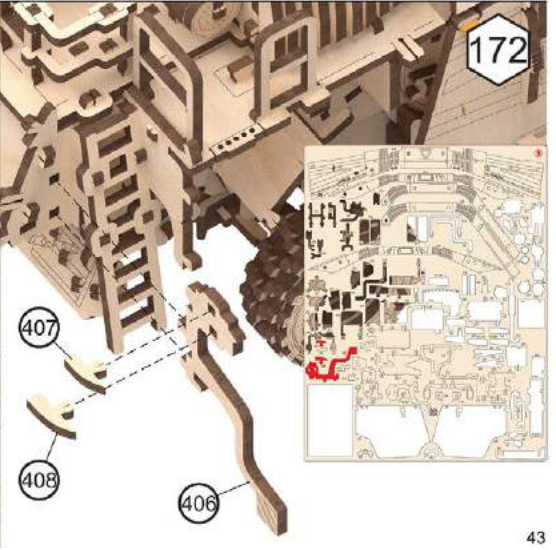
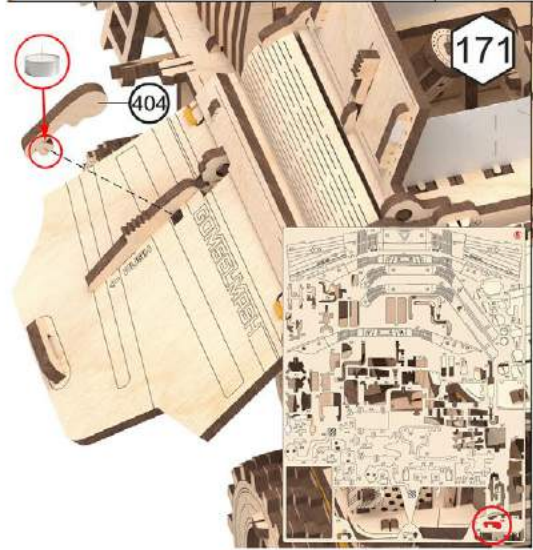
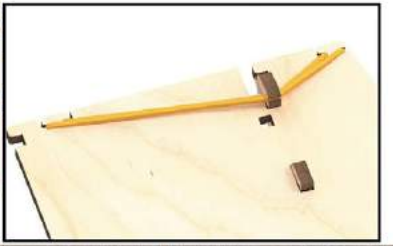
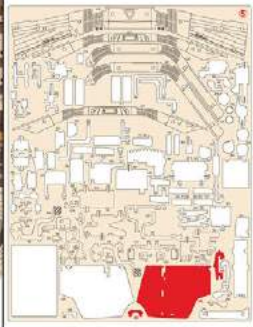
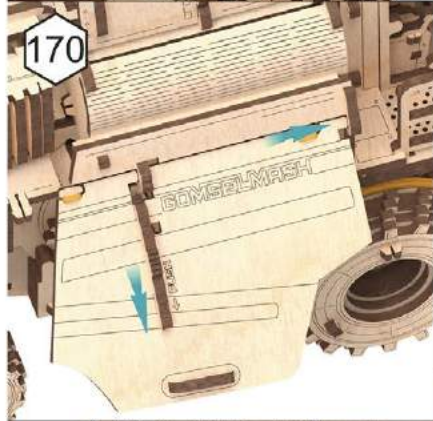
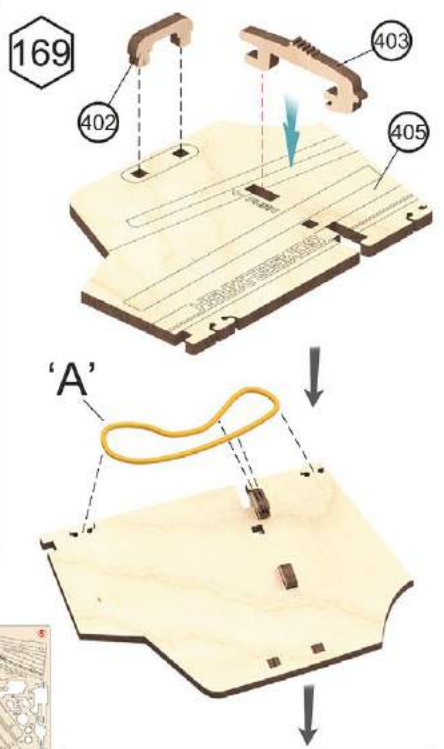
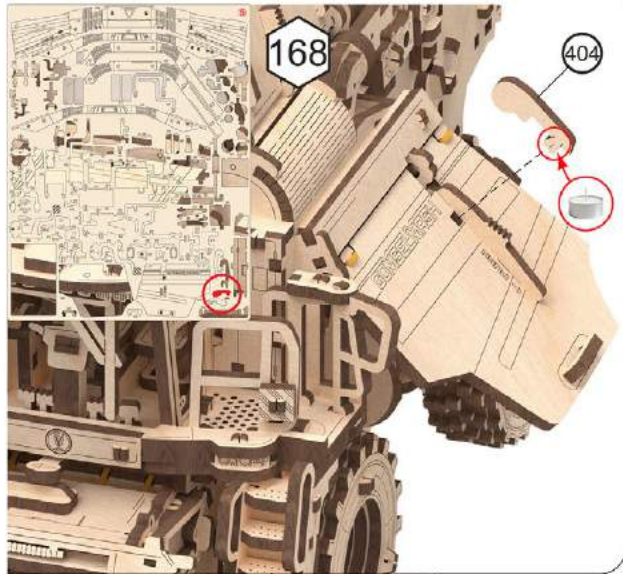

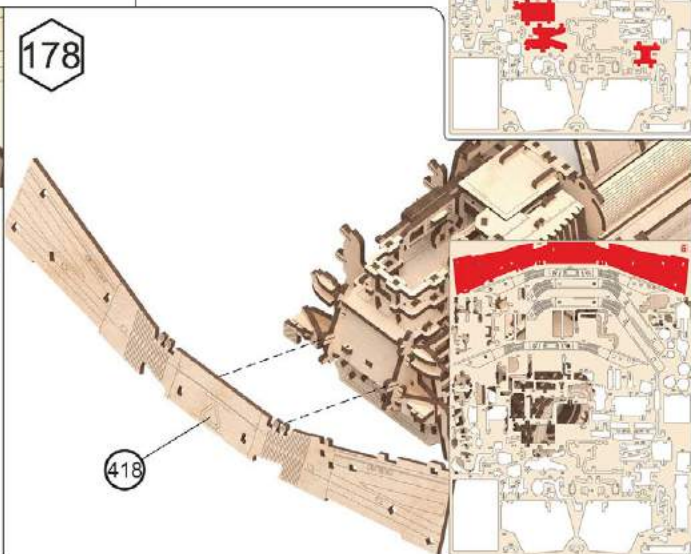
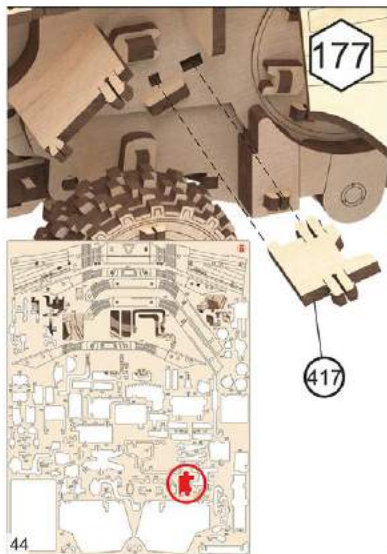
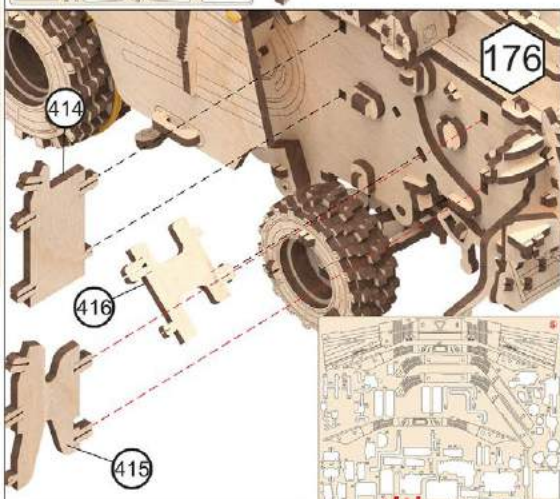
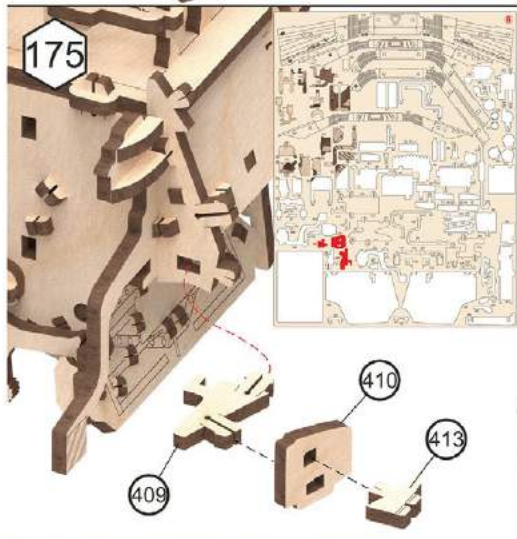
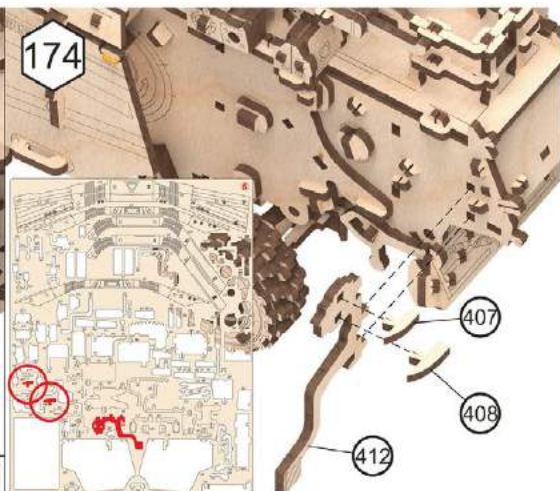
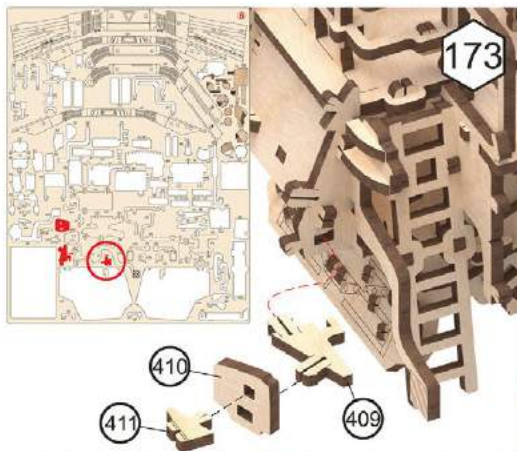

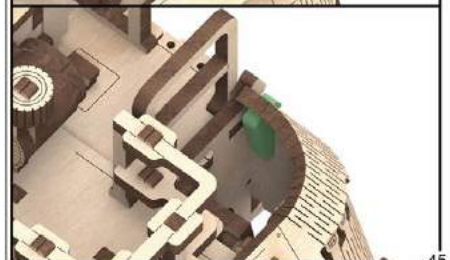
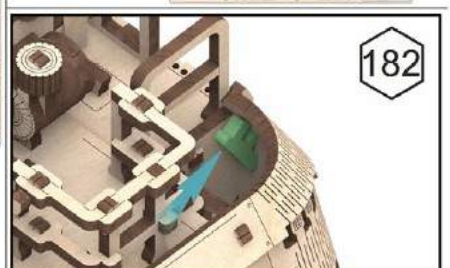
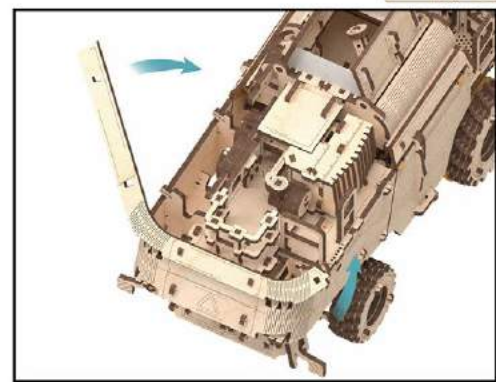
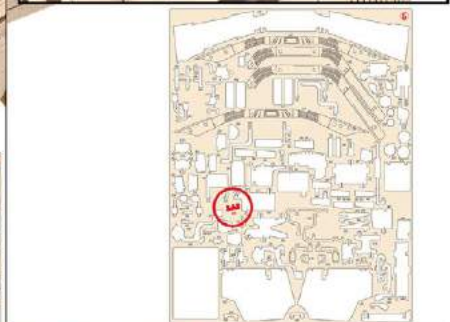
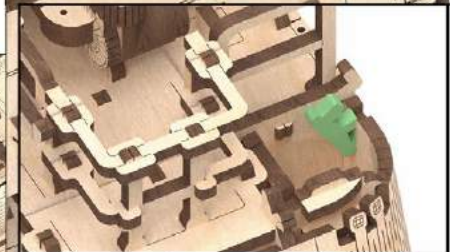
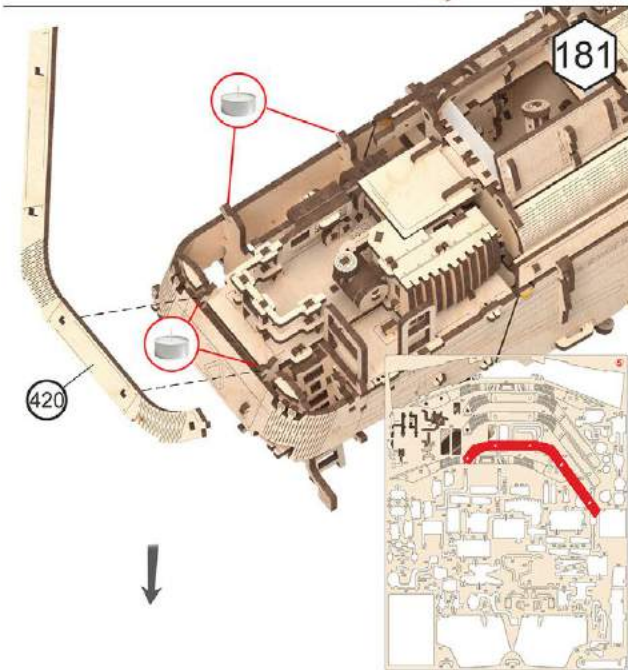
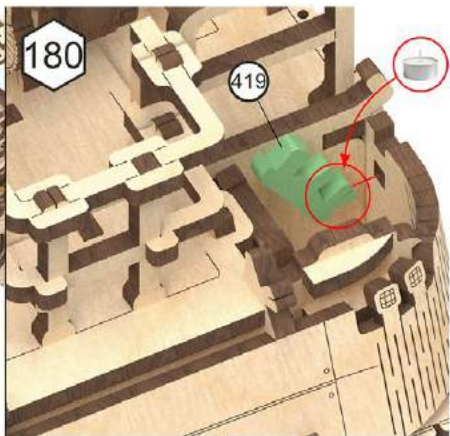
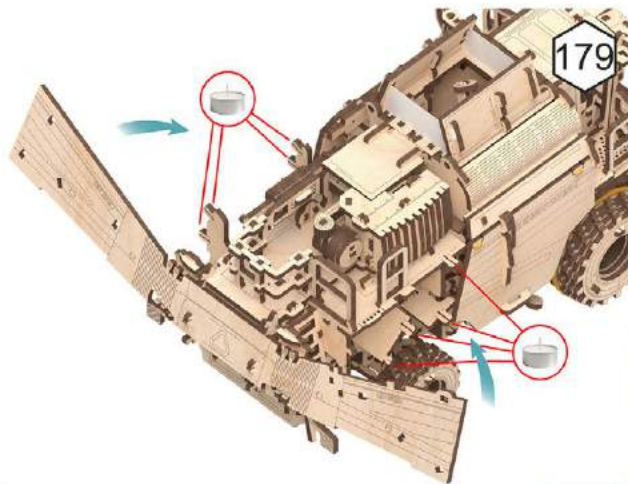

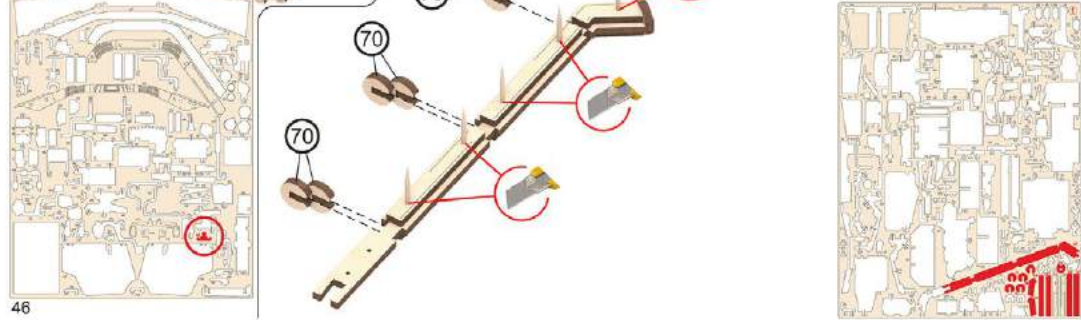
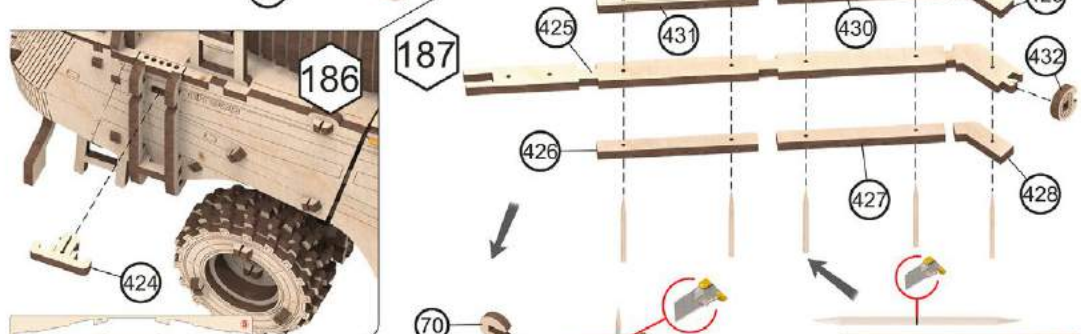
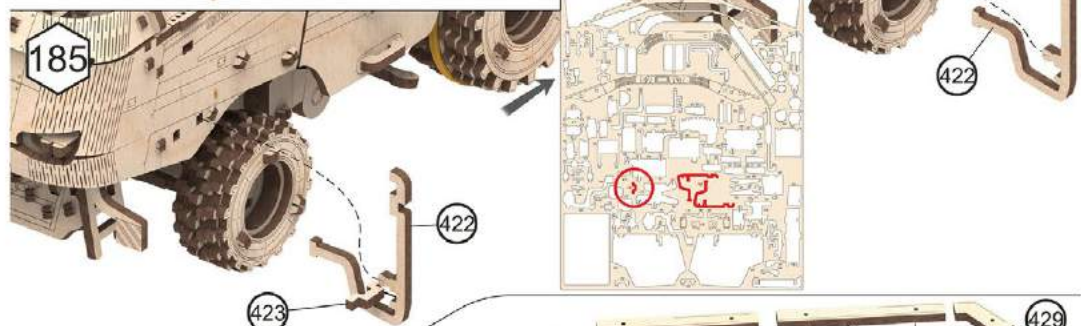
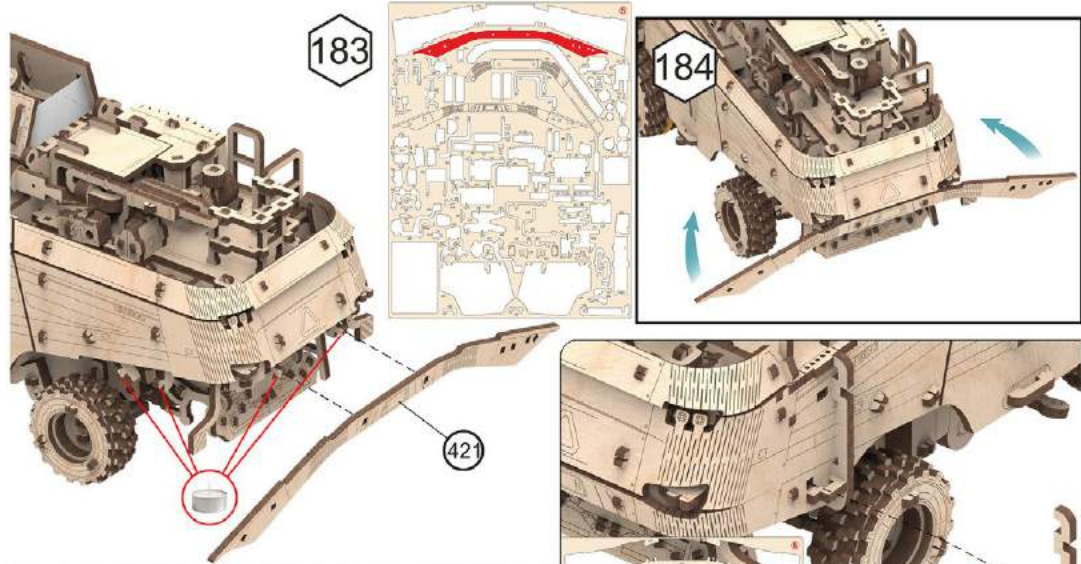

188

433

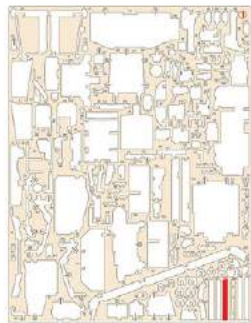

189

434

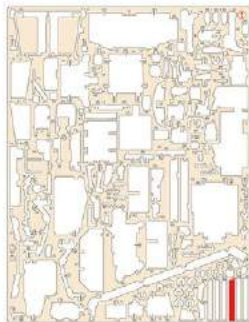
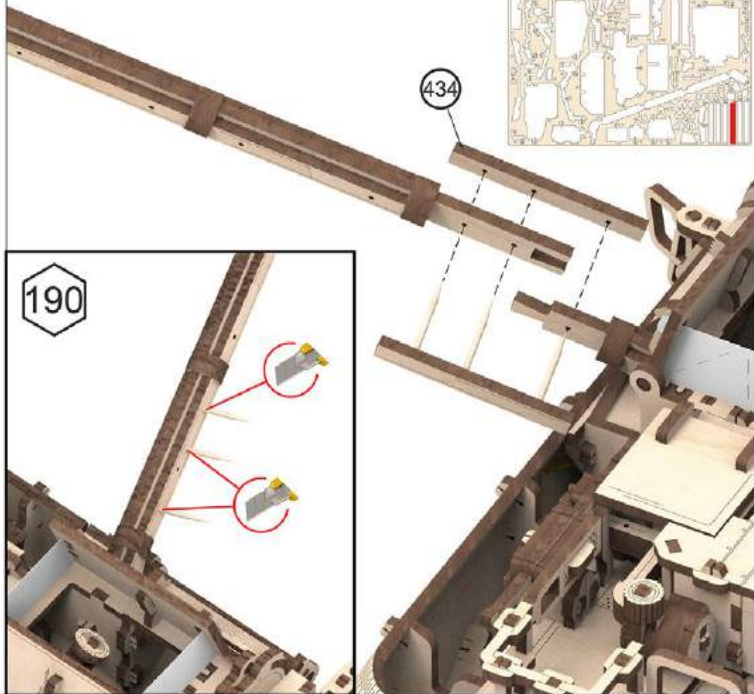

190

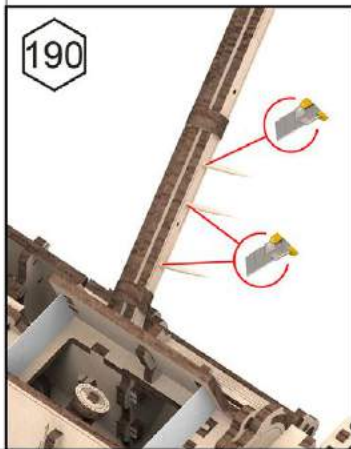

191

436

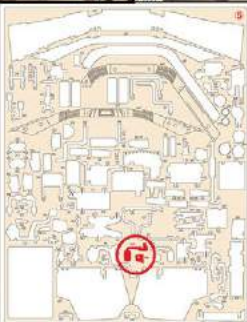
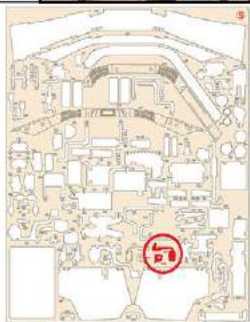
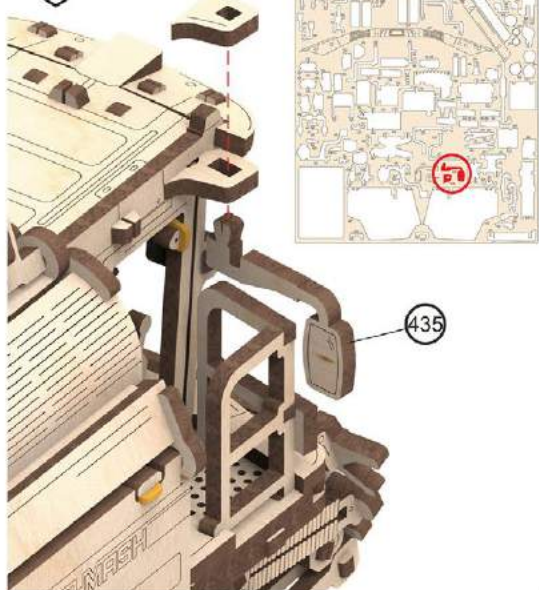

192

438

437

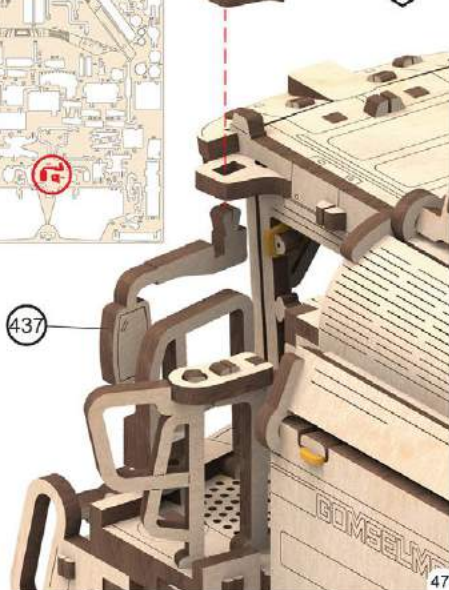

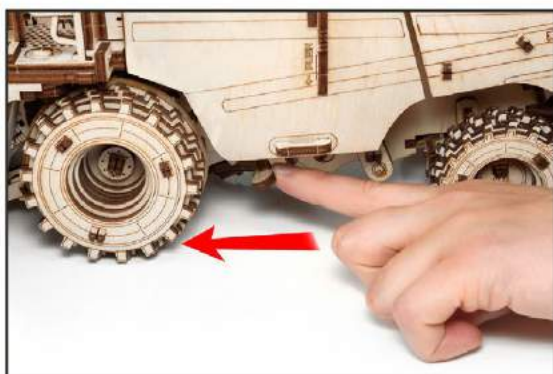
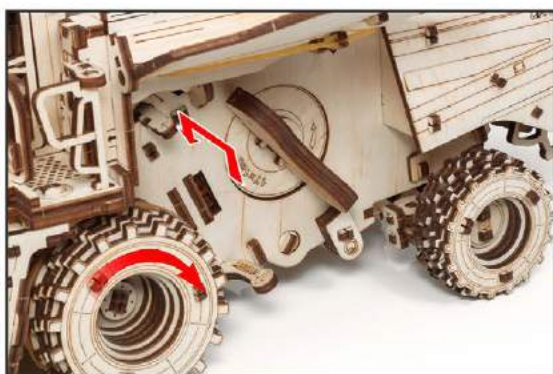

# Assembly Instruction

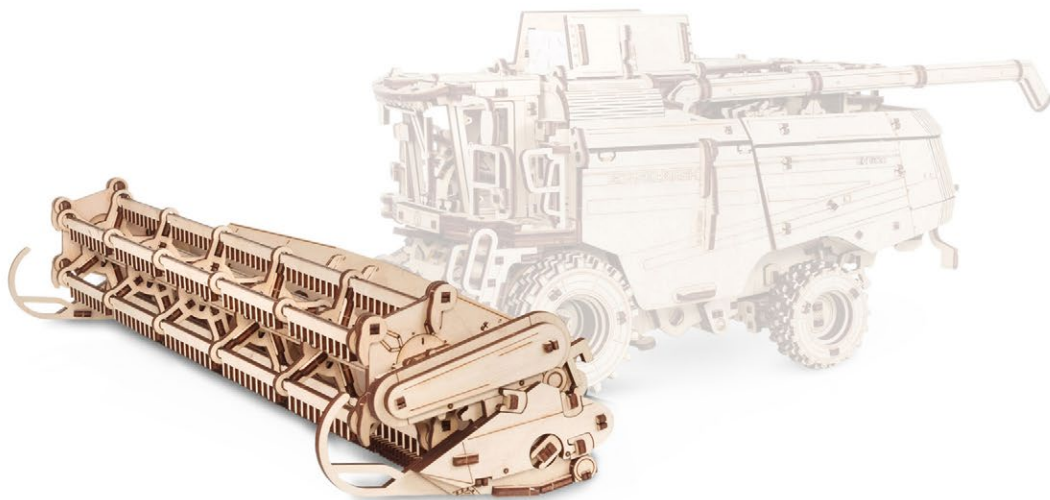

## GRAIN HEADER BARST 920

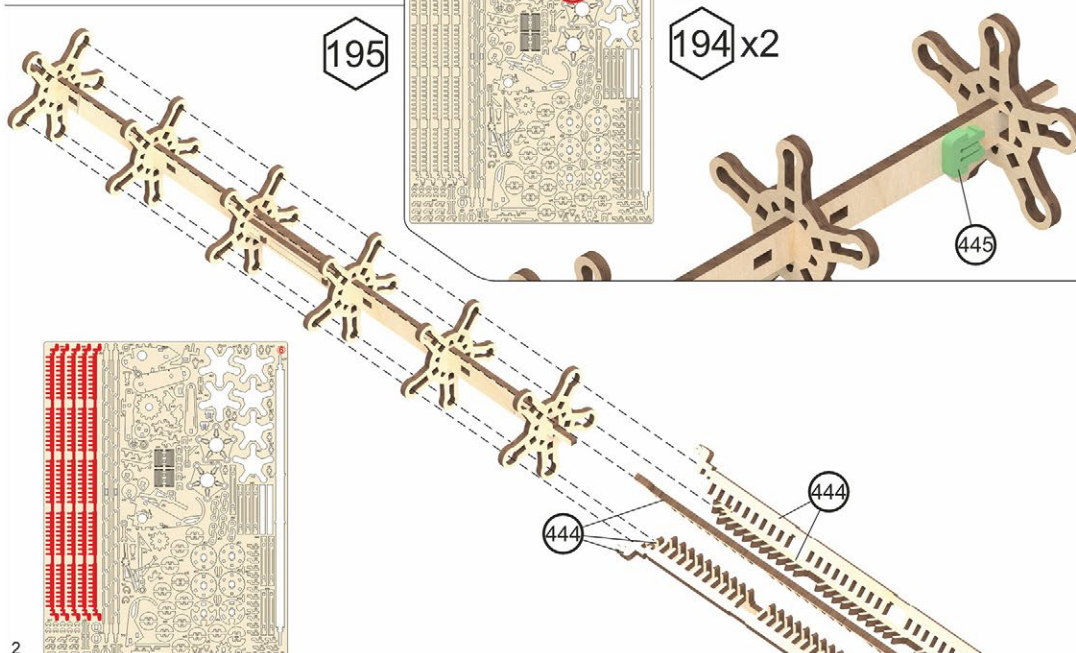
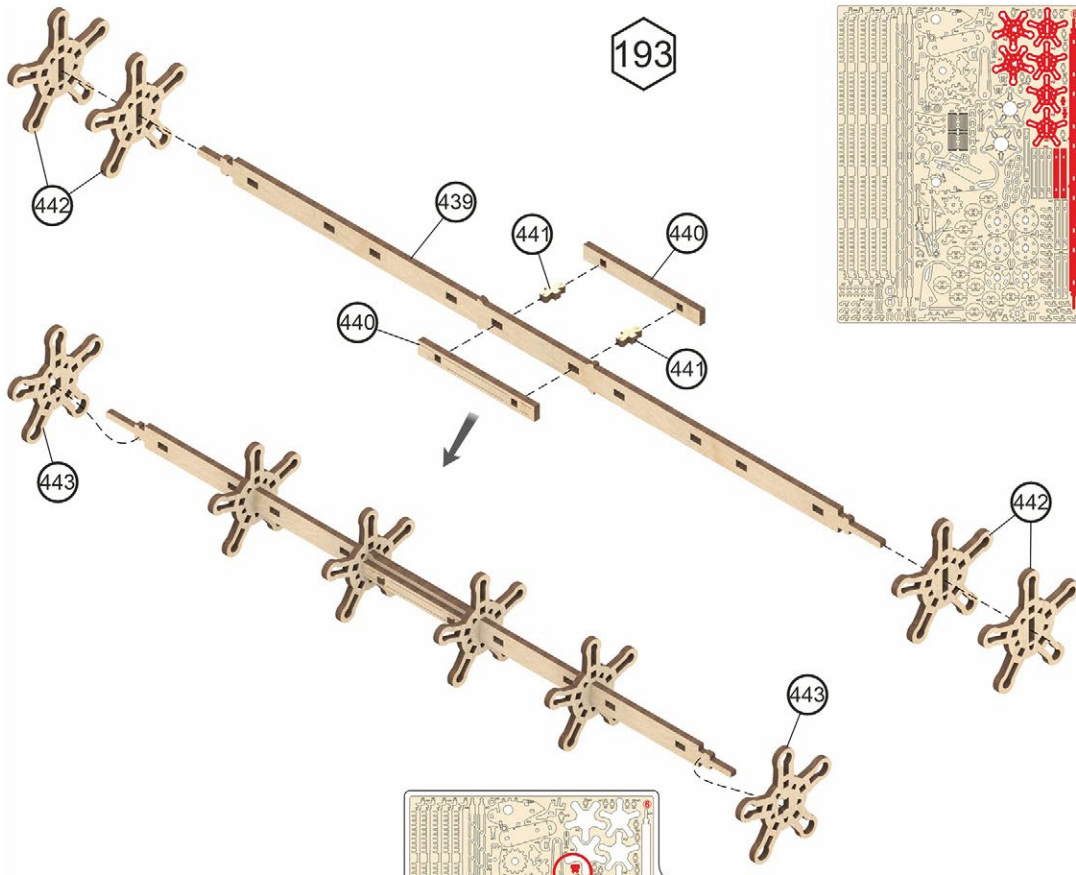

196

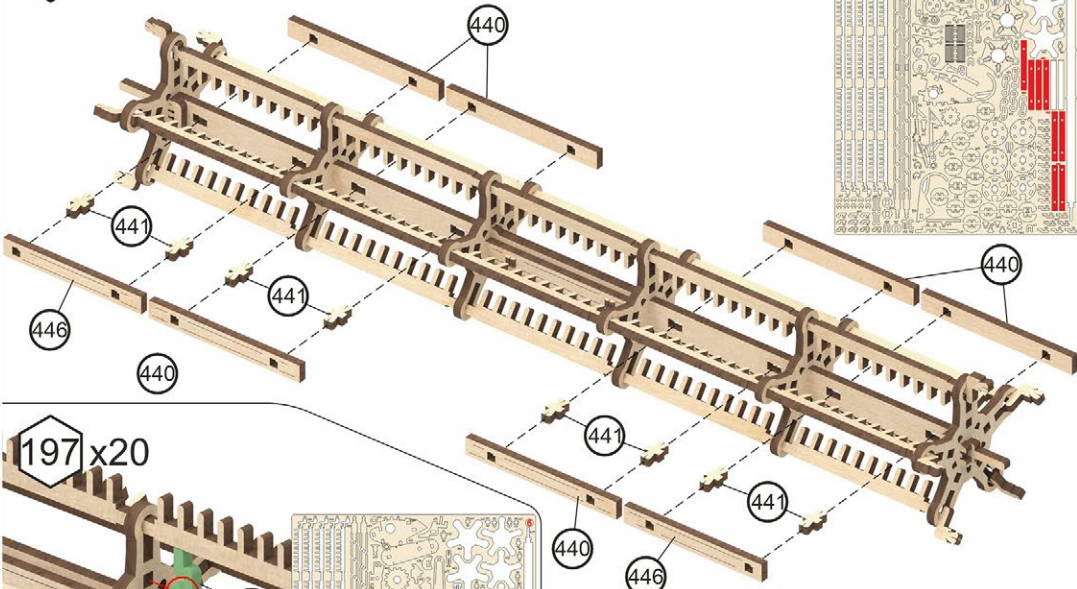

197 x20

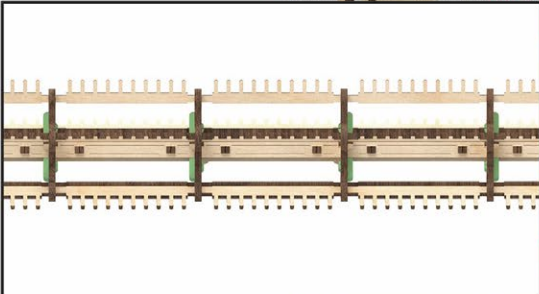
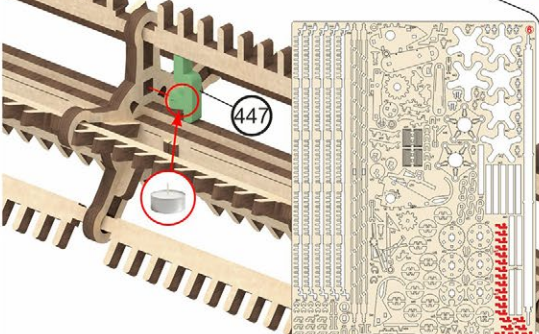

198 x10

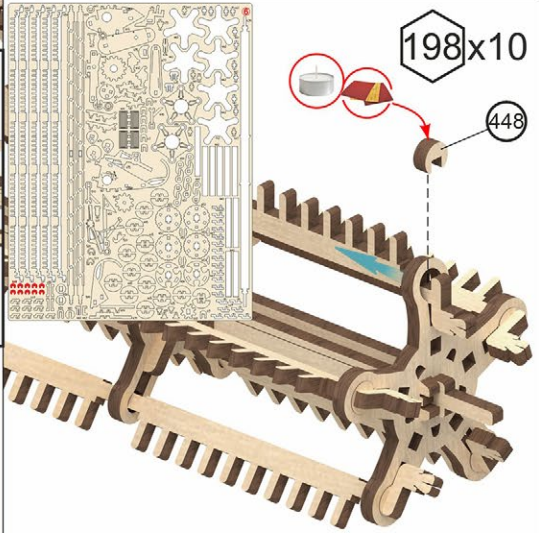

x10

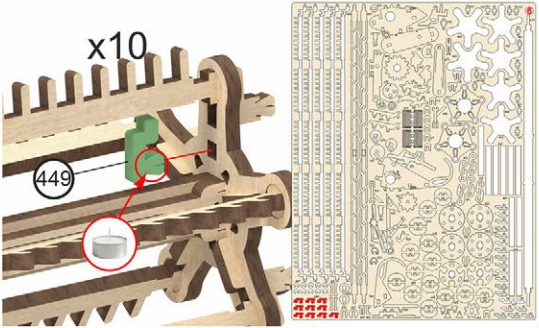

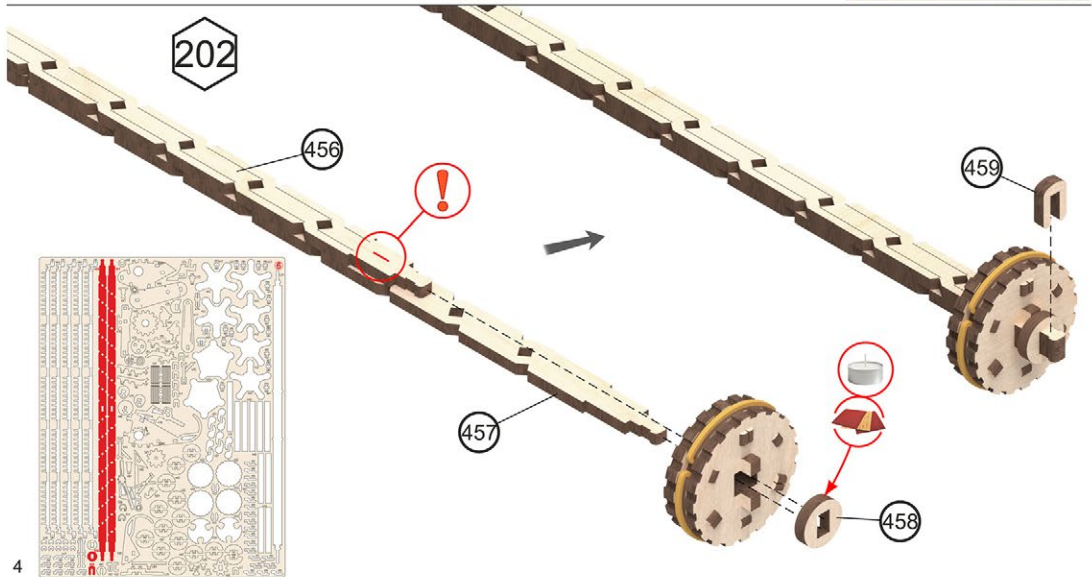
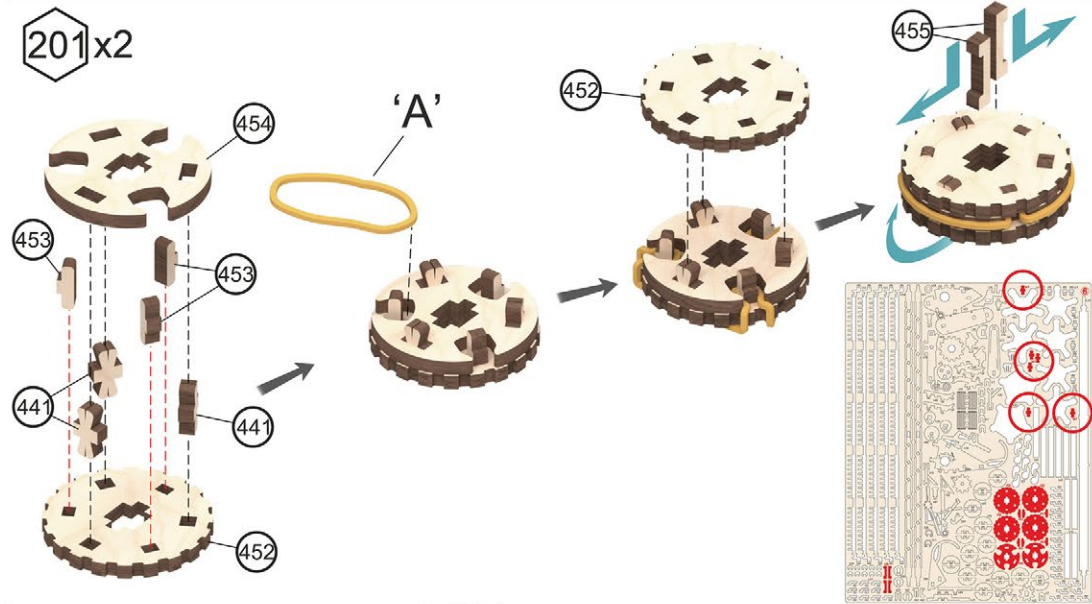
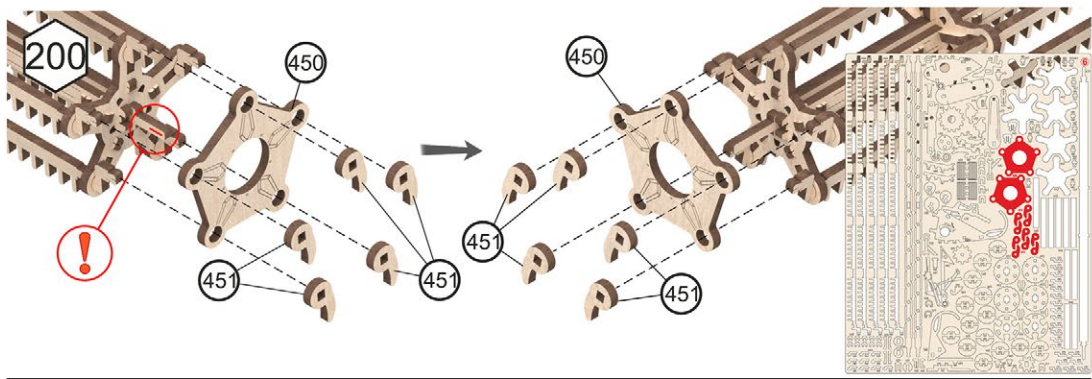

203

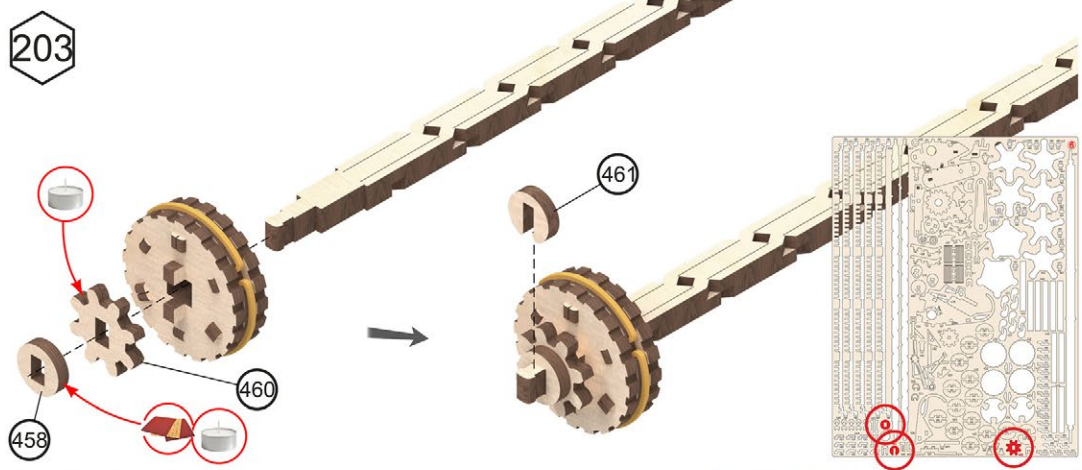

204

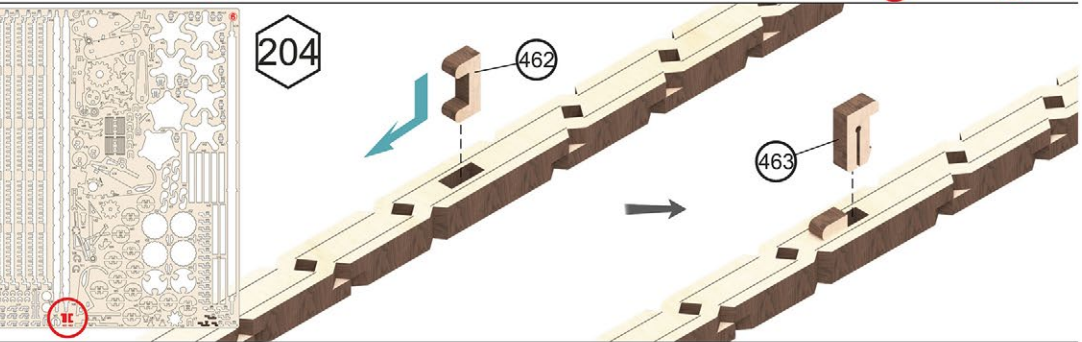

205

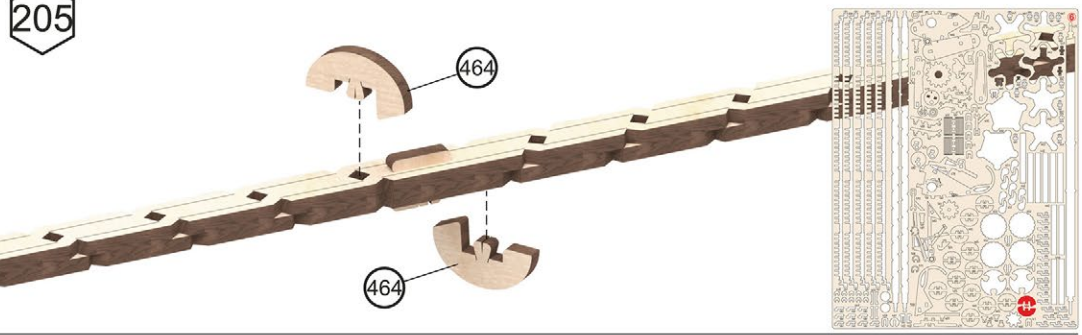

206x26

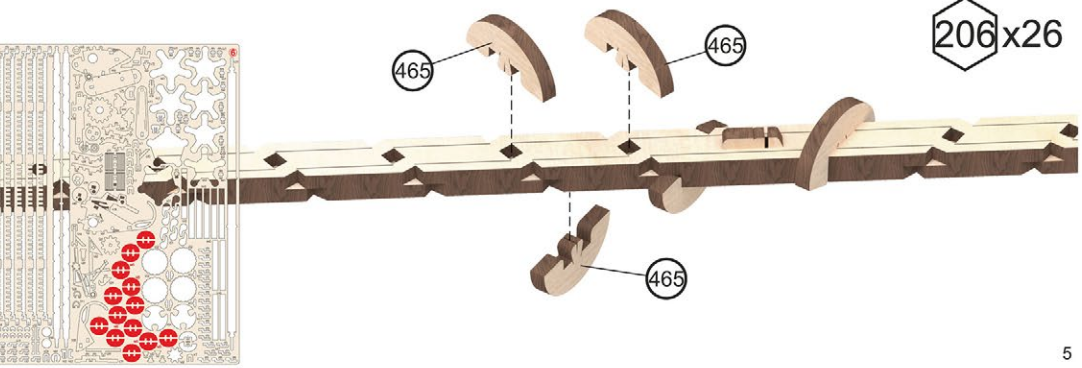

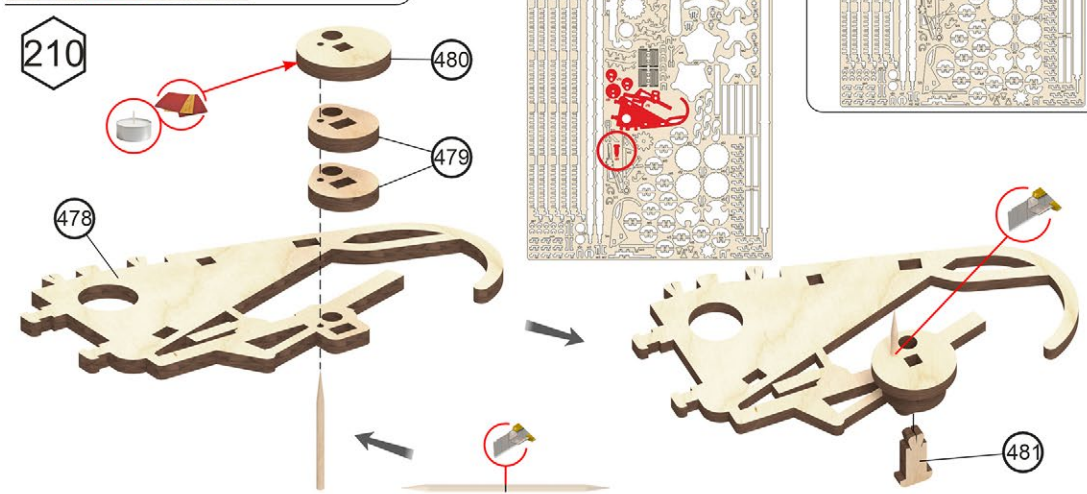
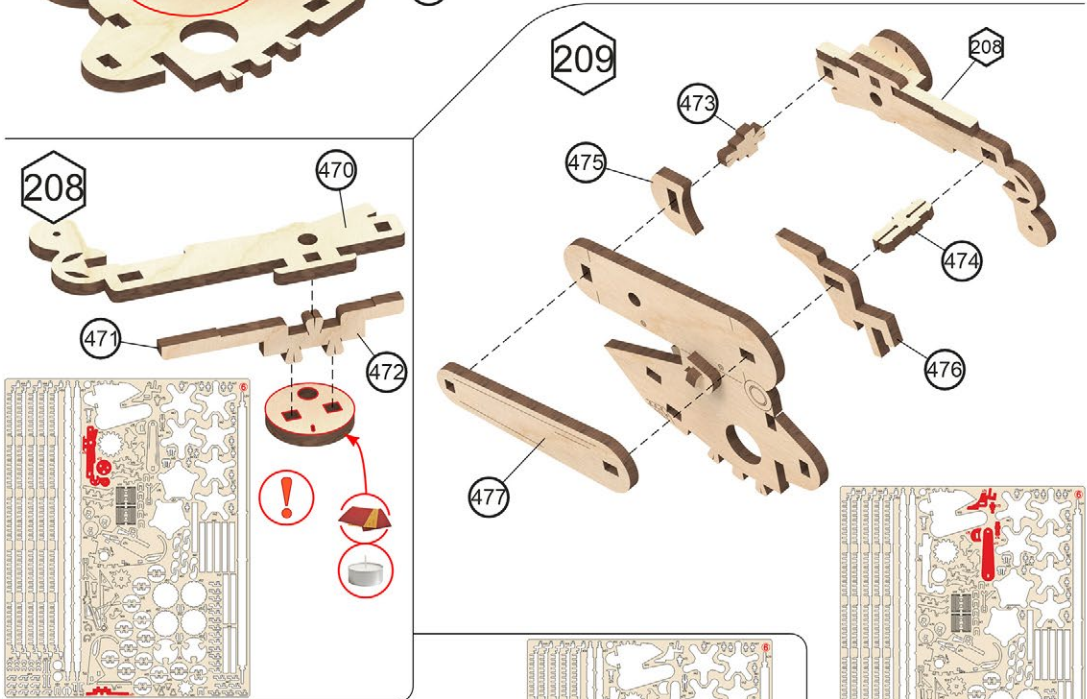
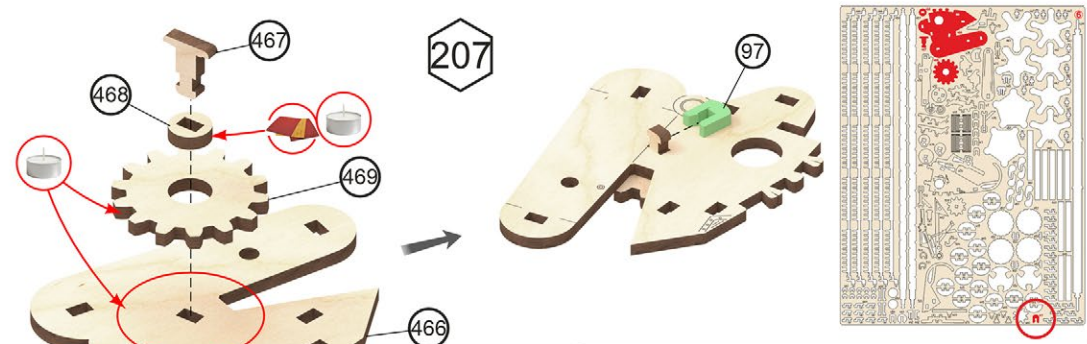

211

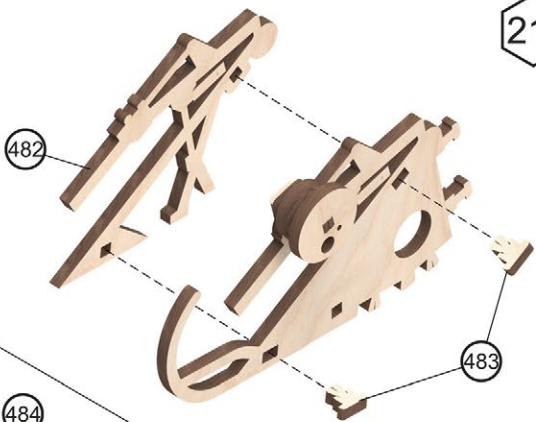

212

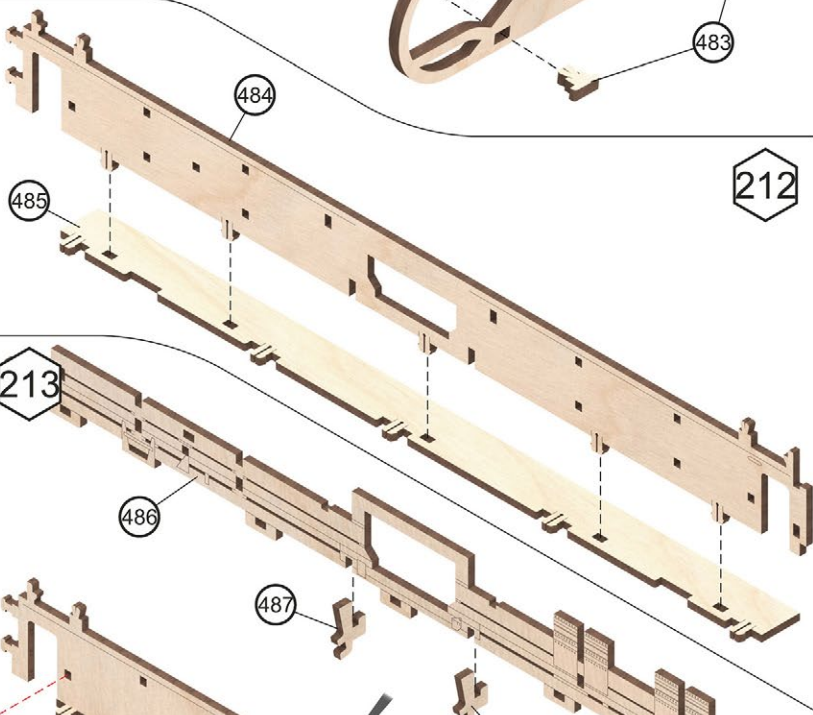

213

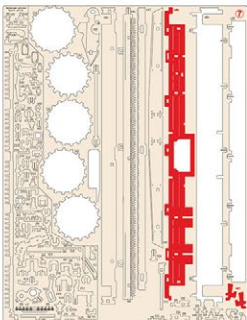
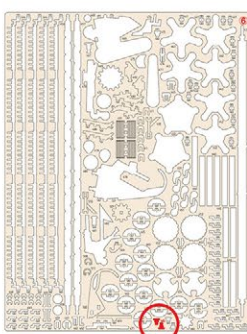
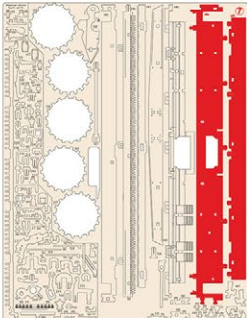
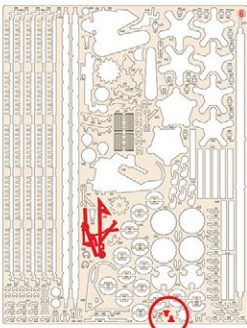
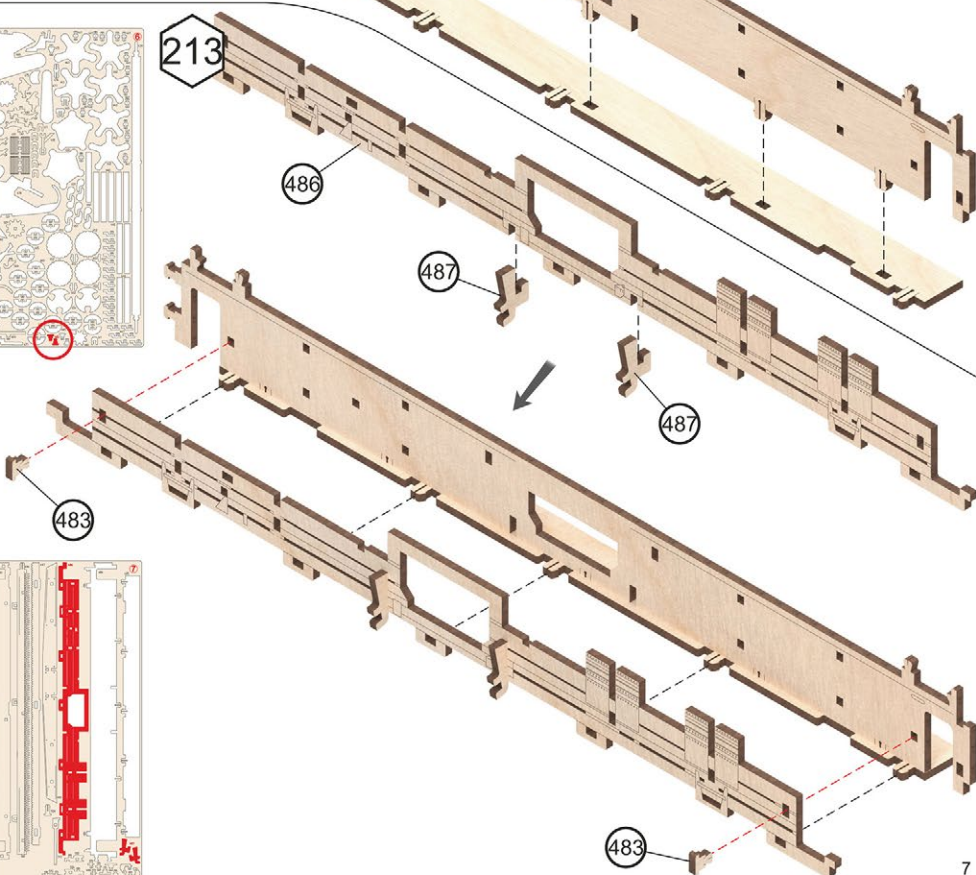

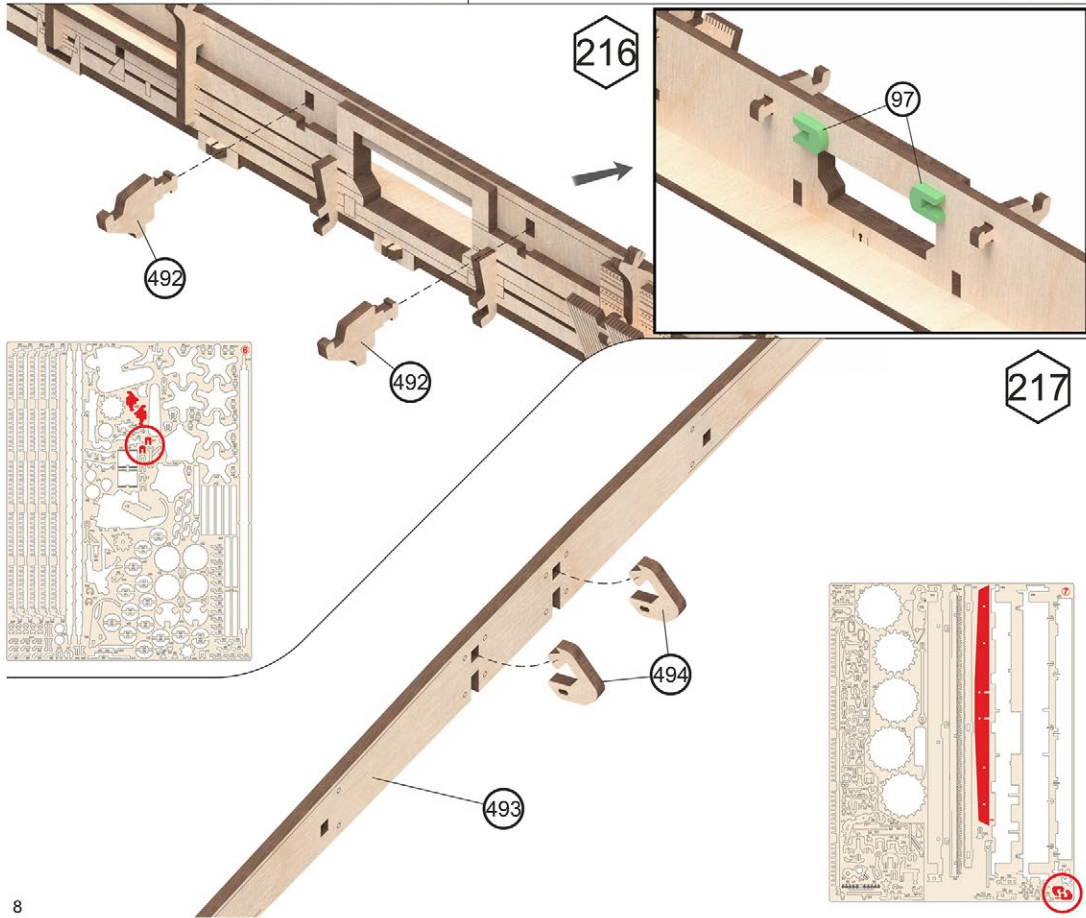
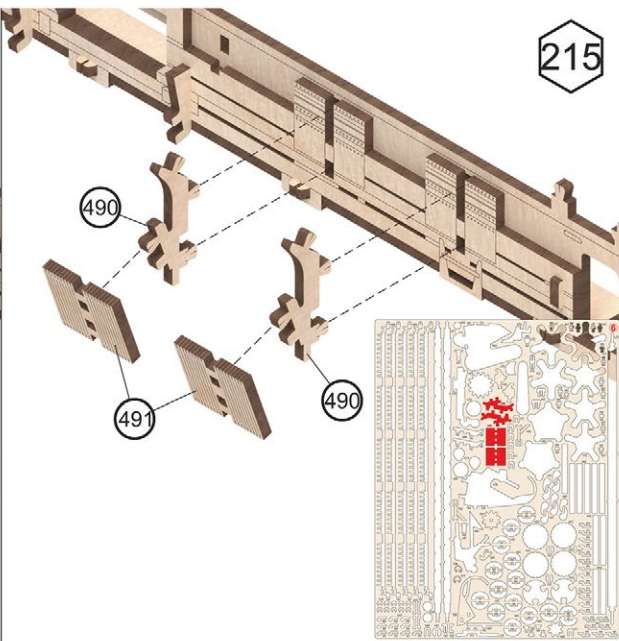
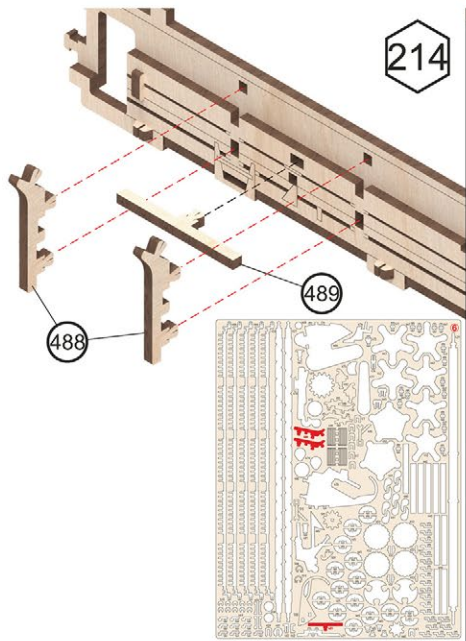

218

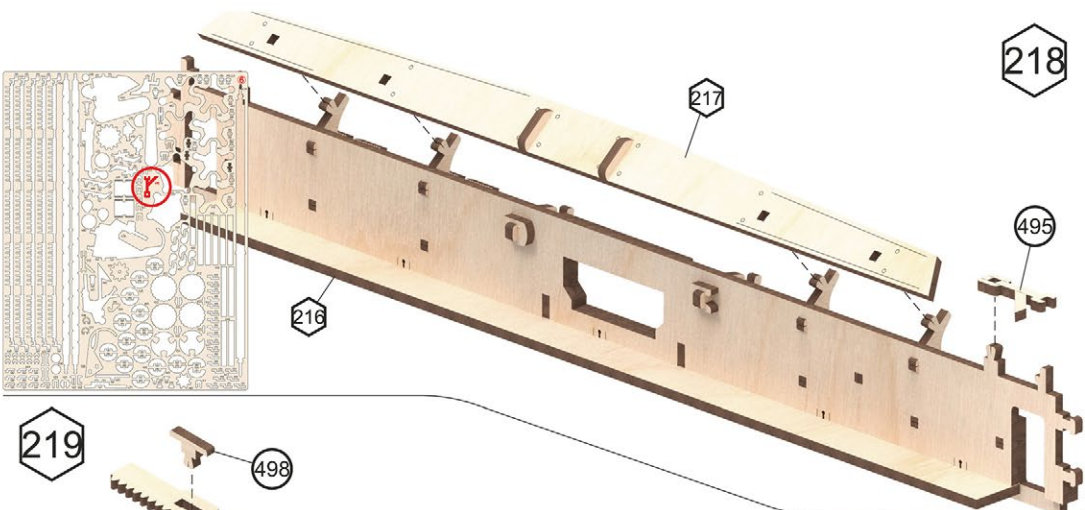

219

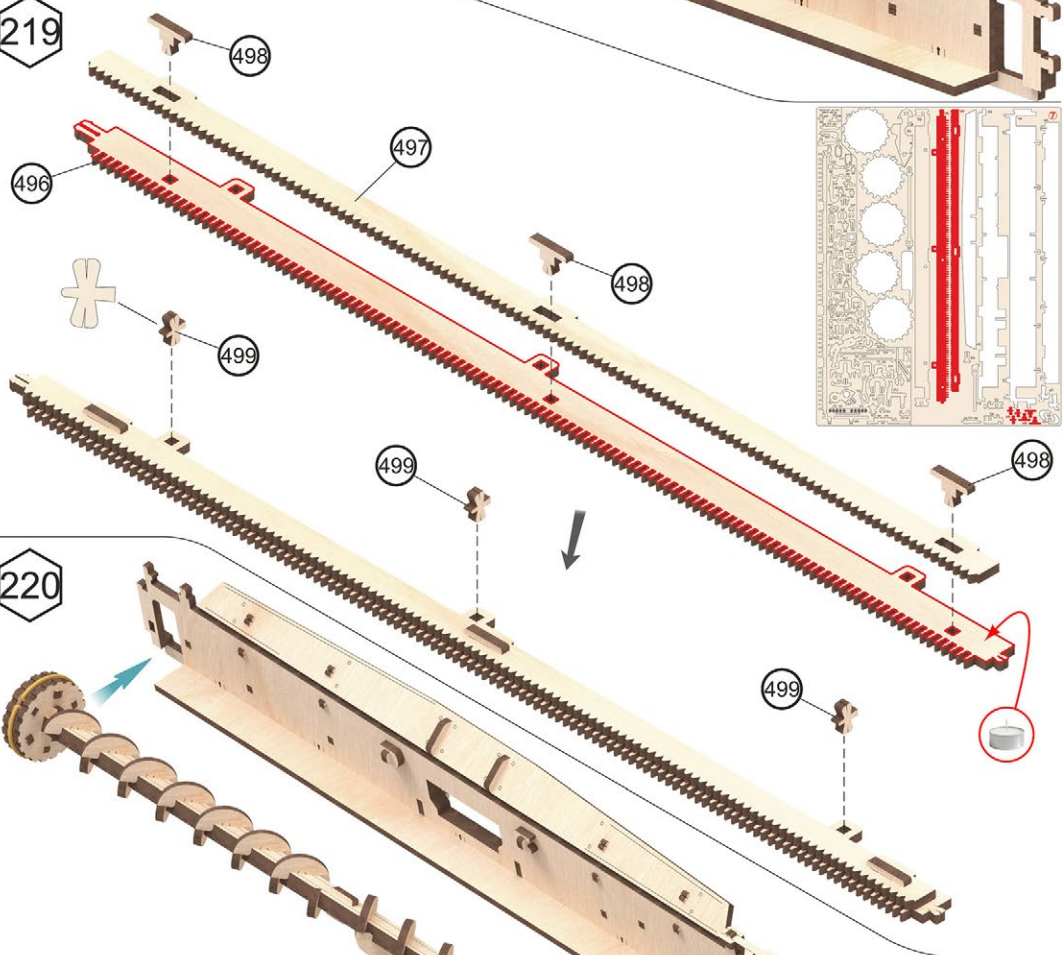

220

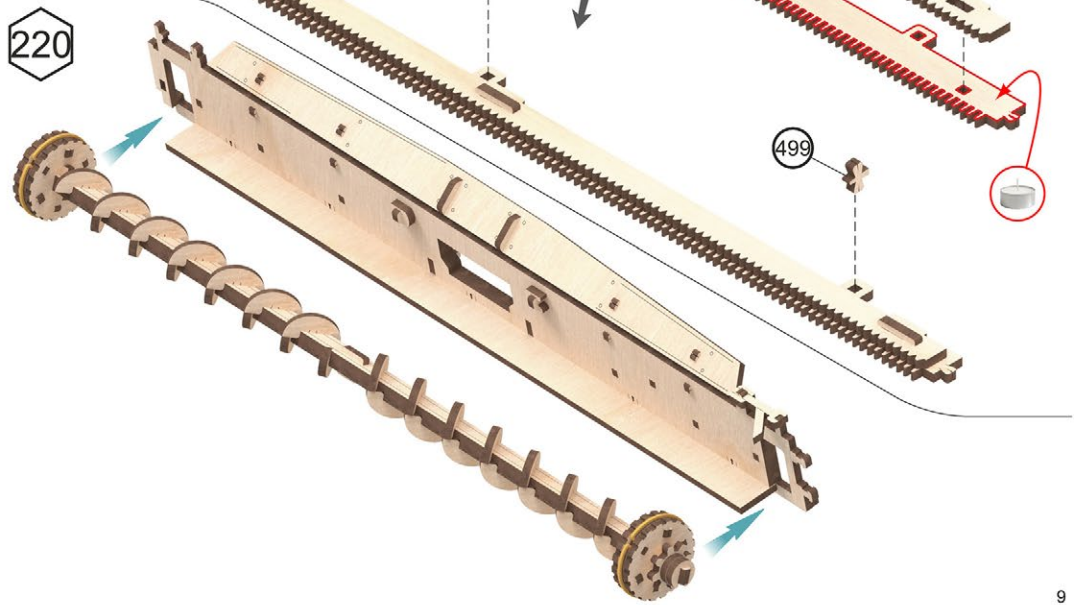

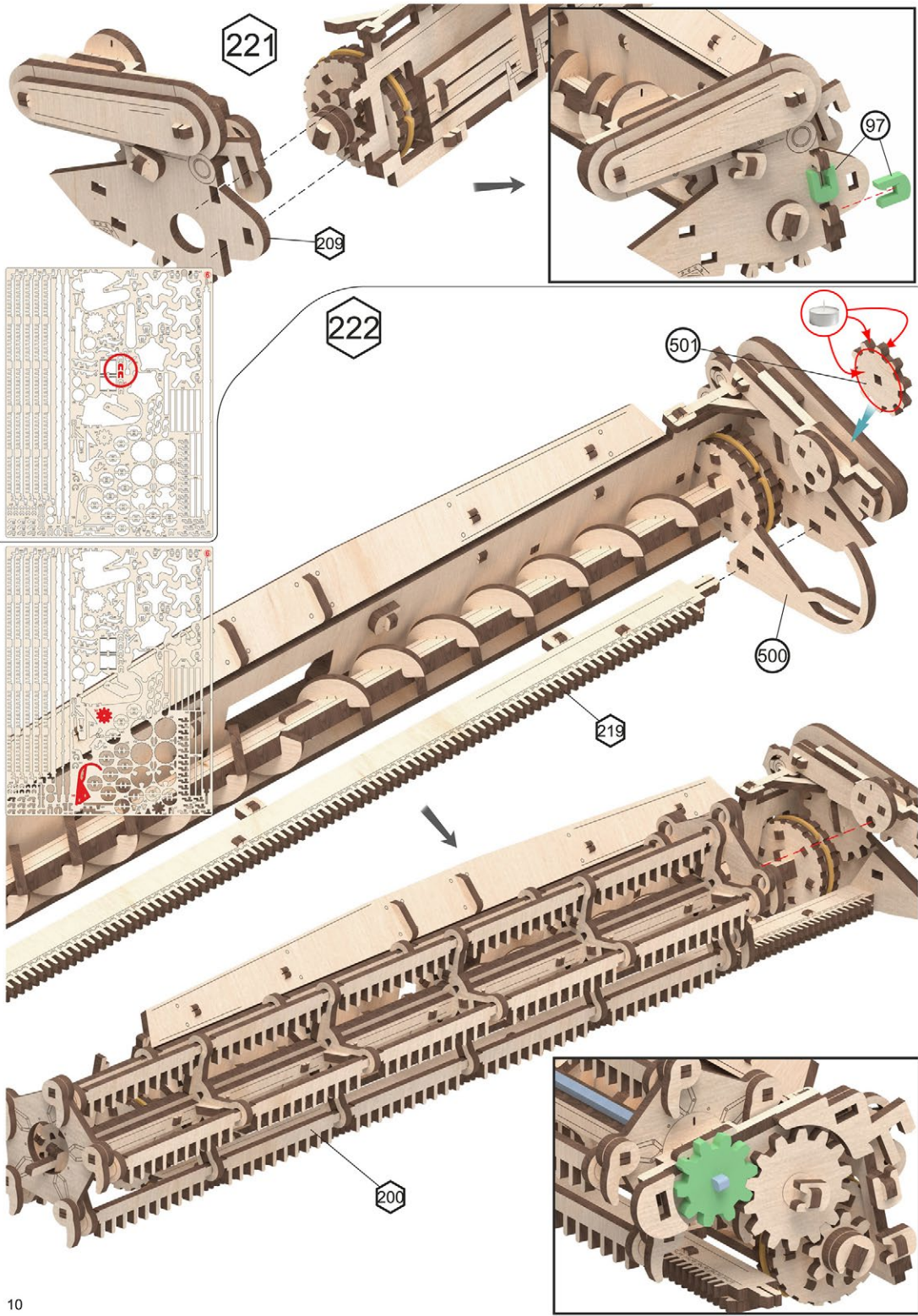

223

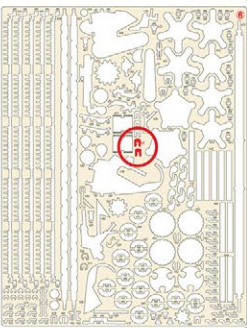
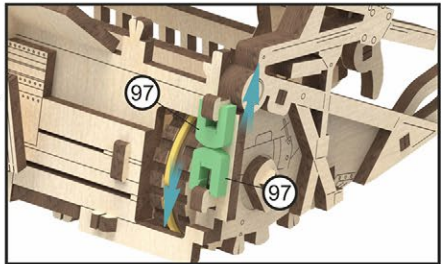

211

504

224

502

503

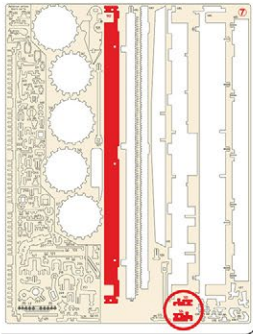
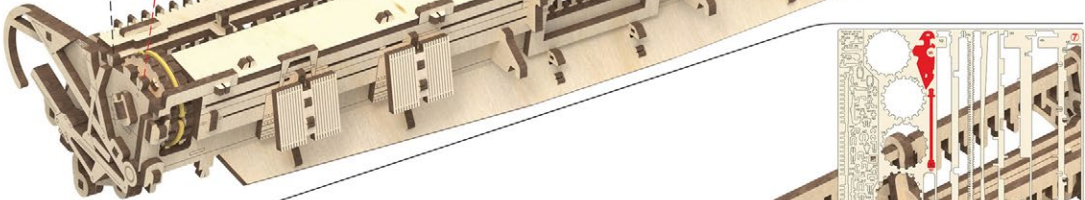

225

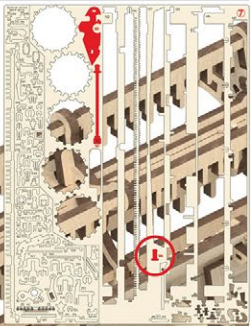

505

507

506

