

# ASSEMBLY INSTRUCTION FOR MODEL

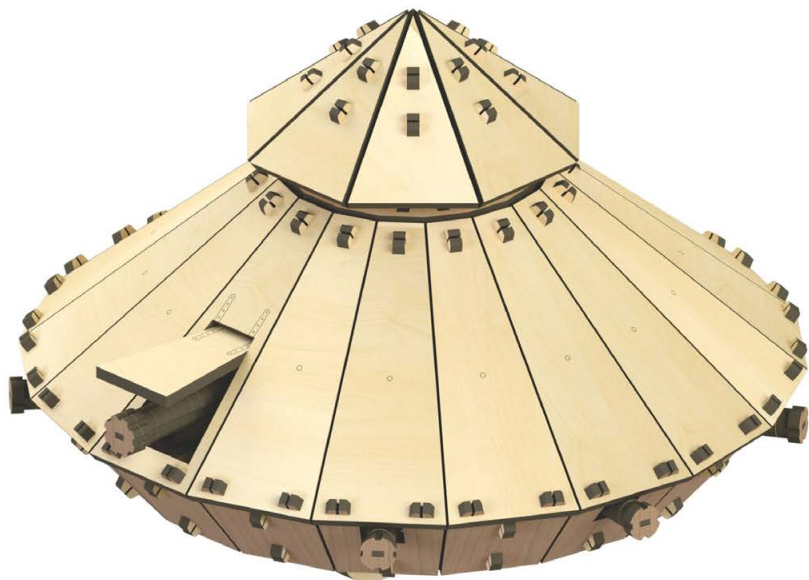

# DA VINCI TANK

EN The ledge is for the squeezing the small details out of the board  
 PL Występ w linijce przeznaczony jest do wyciskania małych detali z arkusza sklejk  
 FR La proéminence est conçue pour aider à presser et enlever les petits détails de la feuille  
 ES La repisa es para apretar los pequeños detalles fuera del tablero  
 DE Der Vorsprung dient dazu, kleine Teile aus den Platten zu drücken  
 RU Выступ предназначен для выдавливания из листа мелких деталей  
 IT Le proiezioni riportate sui fogli di istruzione sono utili anche nella fase di smontaggio per estrarre i pezzi  
 CZ Použitje k vytlačení malých částí z desky  
 CN 輔助測量尺可幫助取出或緊壓細小零件時使用



EN Use for the change the length  
 PL Stosować do wyznaczenia długości  
 FR Appliquer pour définir la longueur  
 ES Utilizar para determinar la longitud  
 DE Zur Änderung der Länge verwenden  
 RU Использовать для определения длины  
 IT Usare per determinare la lunghezza  
 CZ Použitje pro změnění délky  
 CN 用它來 測量長度

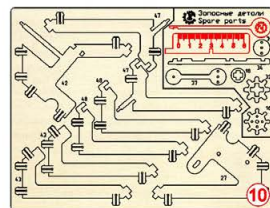
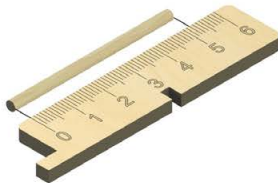

EN Rubber bands  
 PL Gumki recepturki  
 FR Des élastiques  
 ES Gomas elásticas  
 DE Gummibänder  
 RU Резинки  
 IT Elastici  
 CZ Gumičky  
 CN 枚橡皮筋



EN Cut it with a razor blade  
 PL Odetnij nożem do kopert  
 FR Couper avec un cutter  
 ES Cortar con un bisturí  
 DE Mit Rasierklinge durchschneiden  
 RU Обрезать канцелярским ножом  
 IT Tagliare con un coltello da cancelleria  
 CZ Vyřizněte řezákem  
 CN 用刀片切斷



EN Remove the burrs with sandpaper  
 PL Usunąć zadziory papierem ściernym  
 FR Retirer les bavures avec du papier à polir  
 ES Quitar las rebabas con el papel esmeril  
 DE Grate mit Schleifpapier entfernen  
 RU Удалить заусенцы наждачной бумагой  
 IT Sbavare con carta vetrata  
 CZ Vyhlaďte smirkových papírem  
 CN 用砂紙去除毛刺。



EN Details should rotate freely  
 PL Swobodne obracanie  
 FR Libre rotation  
 ES Rotación libre  
 DE Auf freie Rotation achten  
 RU Свободное вращение  
 IT Rotazione libera  
 CZ Části by se měly volně otáčet  
 CN 流暢地旋轉



EN Wax it with a candle  
 PL Posmaruj za pomocą świecy parafinowej  
 FR Graisser avec une bougie de paraffine  
 ES Engrasar con ayuda de una vela de parafina  
 DE Mit einer Kerze wachsen  
 RU Смазать парафиновой свечой  
 IT Lubrificare con candela di paraffina  
 CZ Navoskujte svíčkou  
 CN 用干蠟燭上蠟潤滑



EN Pay attention  
 PL Uwaga  
 FR Prêter attention  
 DE Achtung  
 RU Уделить внимание  
 IT Prestare attenzione  
 CZ Pozor  
 CN 請注意



EN The manufacturer reserves the right to make changes in the design of the product, not worsening its technical characteristics. Information about the changes made may not be present in this manual.

PL Producent zastrzega sobie prawo do zmiany konstrukcji wyrobu bez pogorszenia jego właściwości technicznych. Niniejsza instrukcja może nie zawierać informacji o zmianach.

FR Le producteur se réserve le droit d'apporter des modifications dans la construction du produit à condition si elles ne portent atteinte à ses caractéristiques techniques. Les renseignements sur les modifications apportées peuvent ne pas être dans la présente notice.

ES El fabricante se reserva el derecho de introducir modificaciones en la construcción del producto, que no empeoren sus características técnicas. Datos sobre modificaciones introducidas pueden no aparecer en esta instrucción.

DE Der Hersteller behält sich das Recht auf Designänderungen, die die technischen Merkmale und Funktionen nicht negativ beeinflussen, vor.

RU Производитель оставляет за собой право вносить изменения в конструкцию изделия, не ухудшающие его технические характеристики. Сведения о внесенных изменениях могут отсутствовать в настоящей инструкции.

IT Il produttore si riserva il diritto di apportare modifiche al design del prodotto, non peggiorando le sue caratteristiche tecniche. Informazioni sulle modifiche apportate potrebbero non essere presenti in questo manuale.

CZ Výrobce si vyhrazuje právo na takové změny v designu produktu, které nebudou mít za následek zhoršení technických vlastností. Informace o změnách nemusí být v návodu uvedeny.

1 CN 製造商保留對產品設計更改的權利，一切改良旨在增強產品的技術性能。改良處若未出現在手冊中，敬請諒解

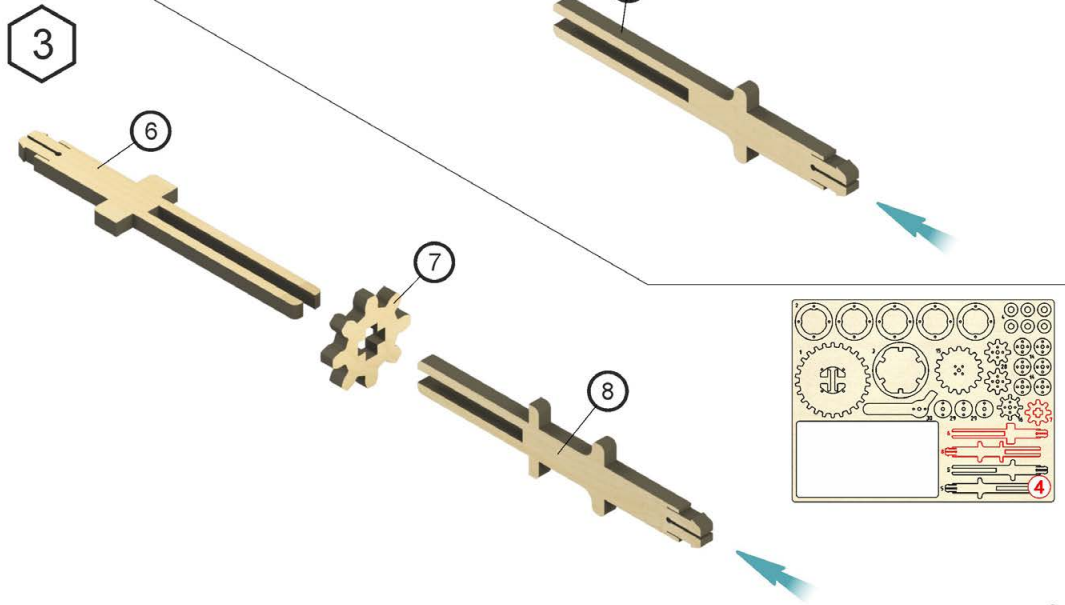
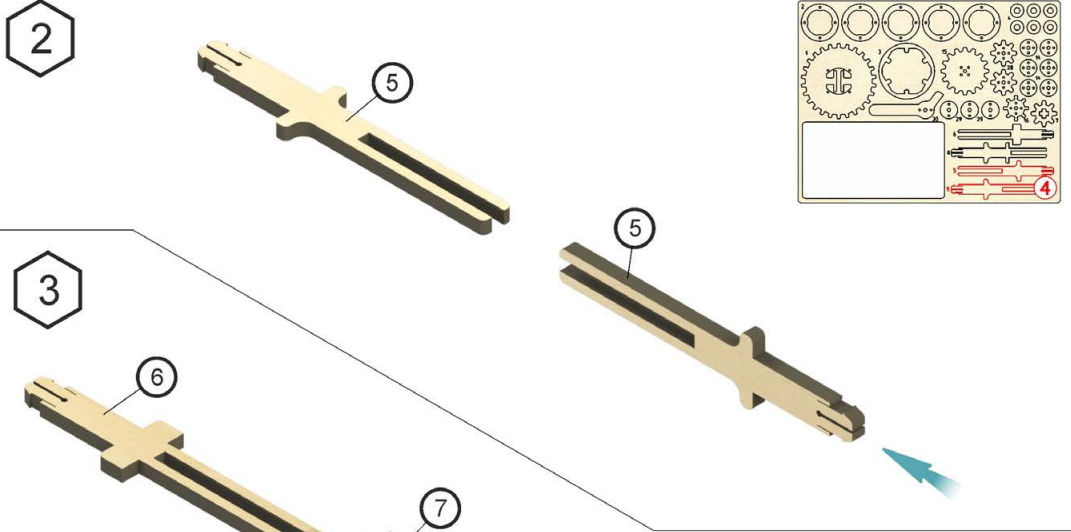
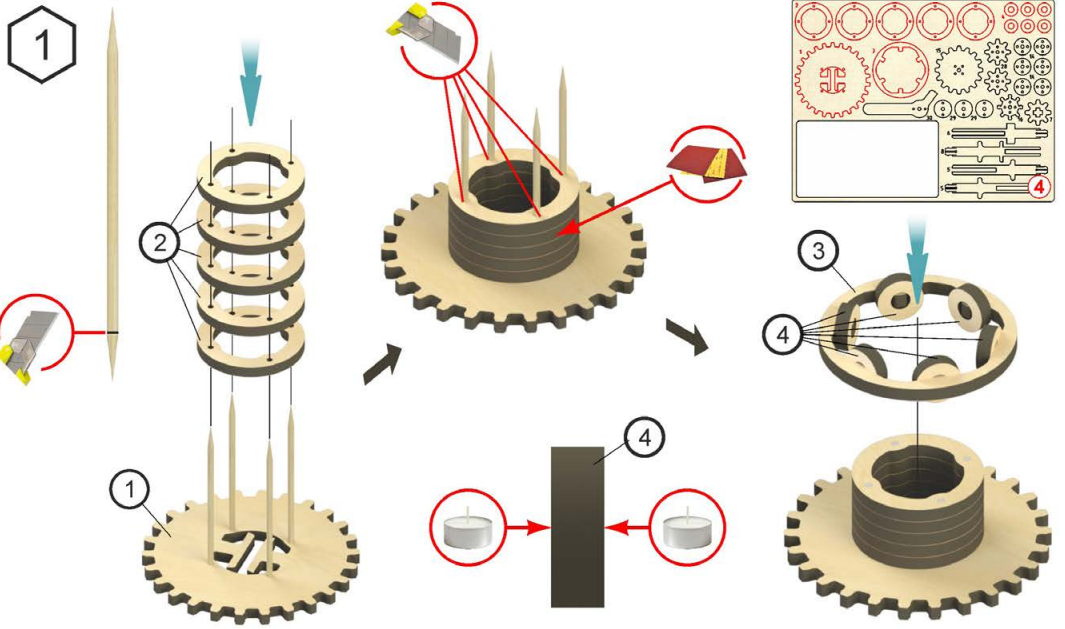

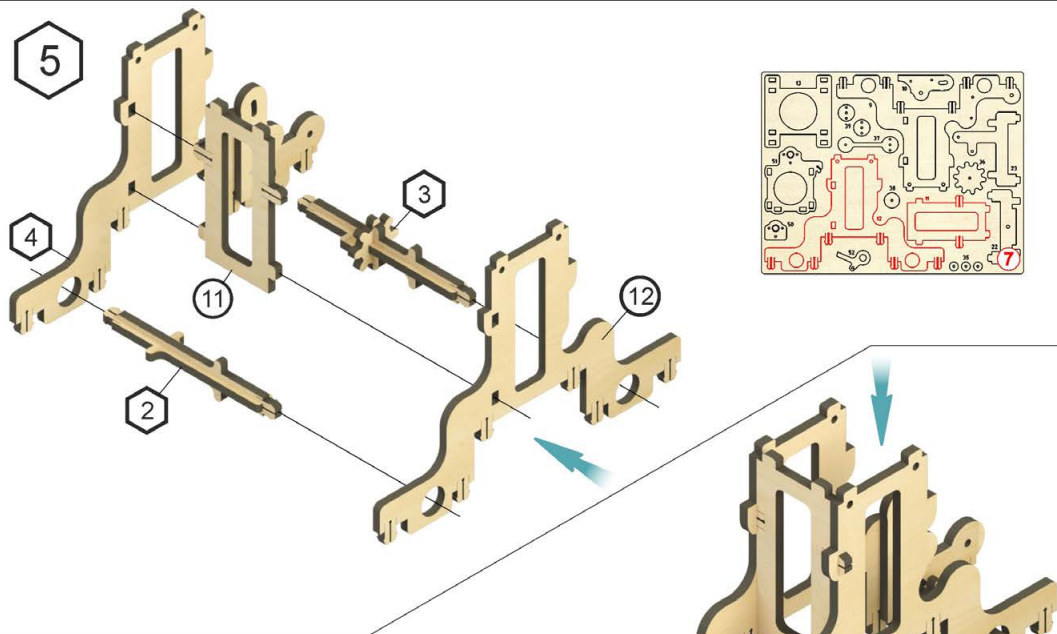
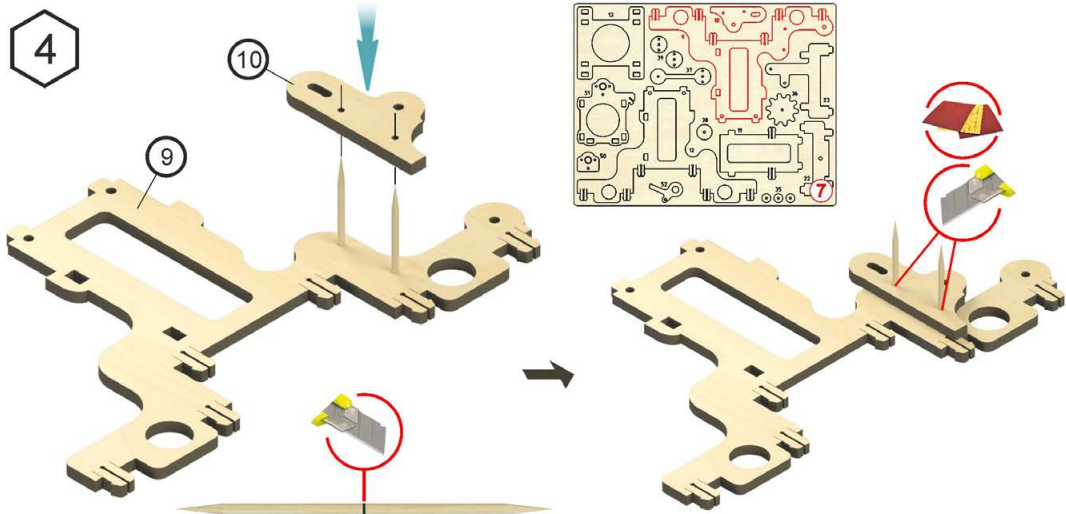

7

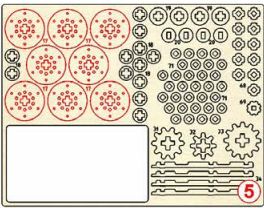
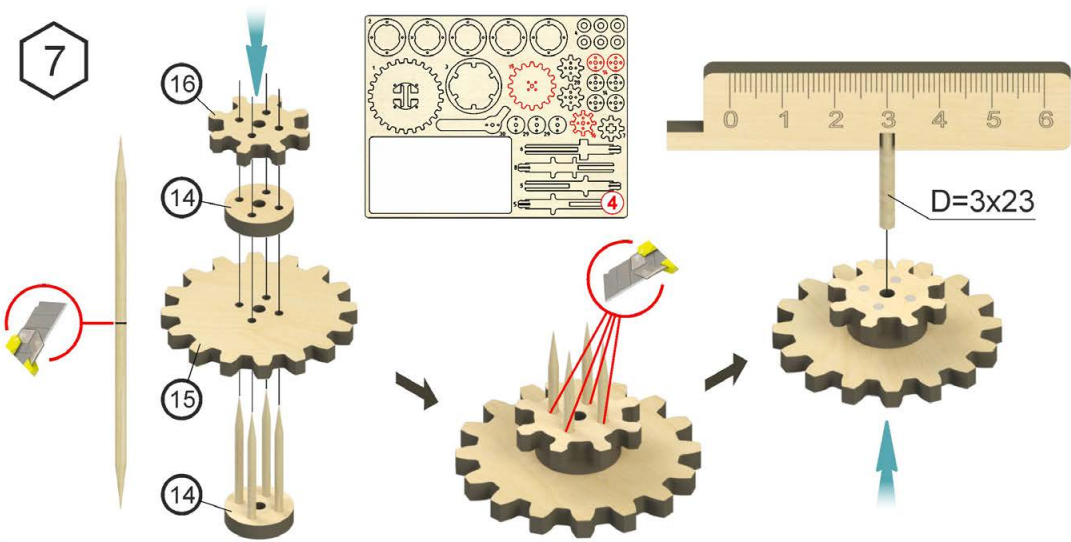

8 x4

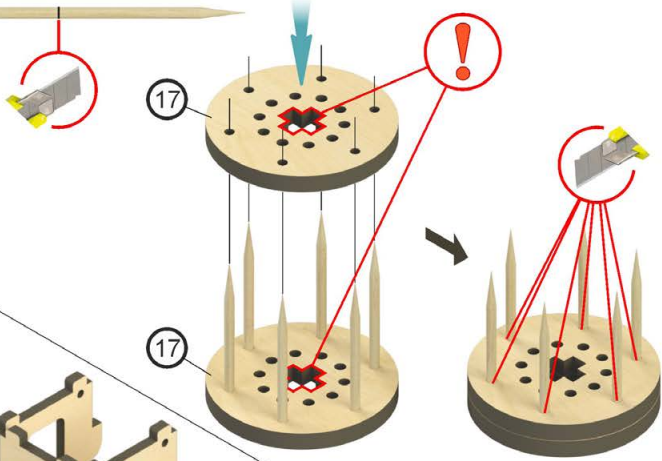

9

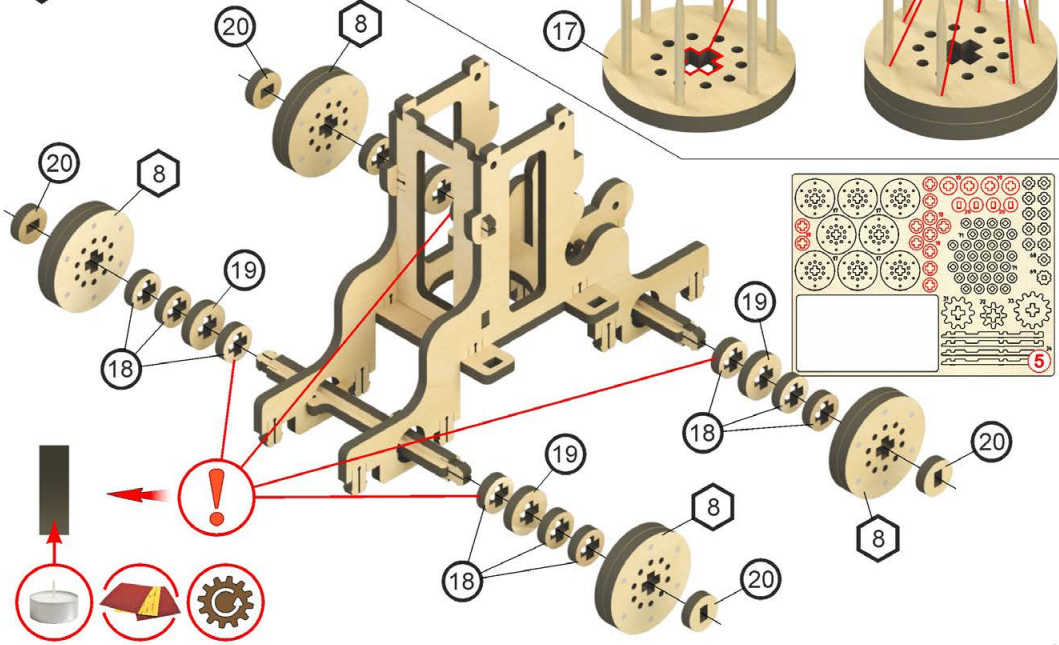

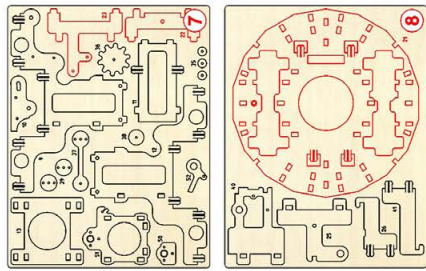

10

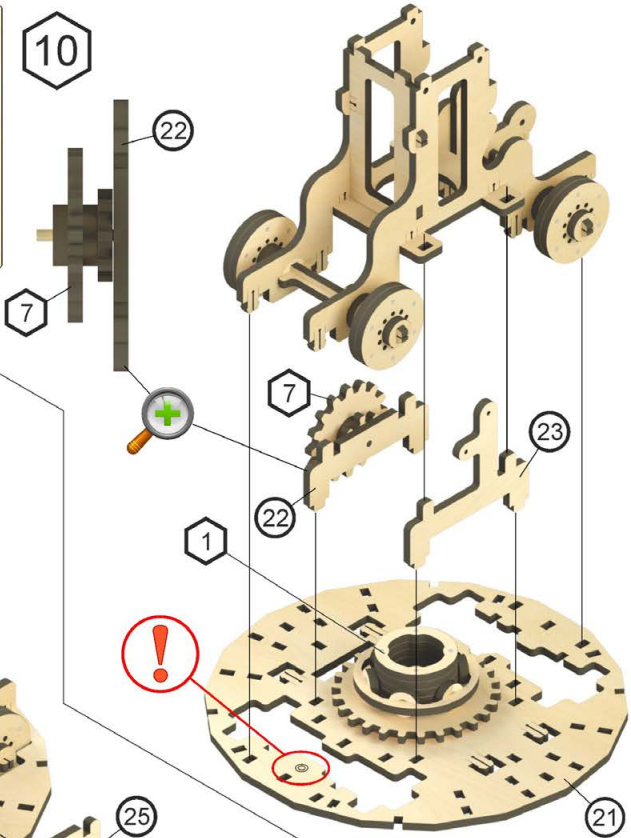

11

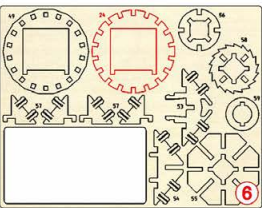
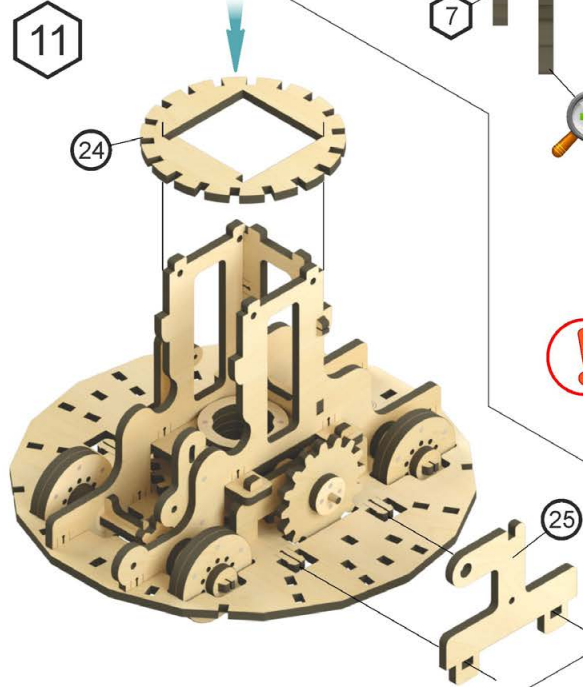

12

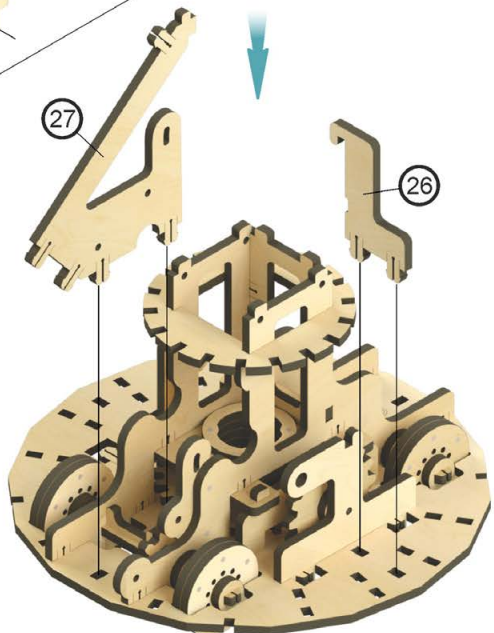
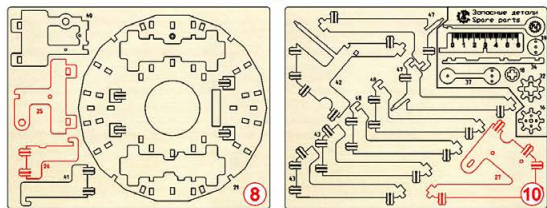

13 x2

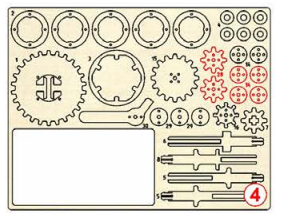
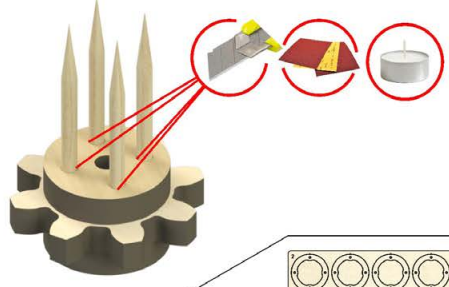
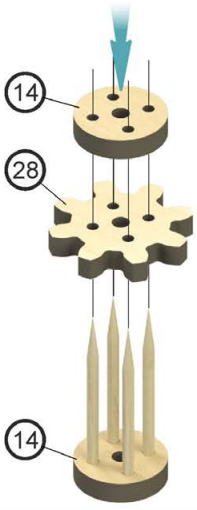
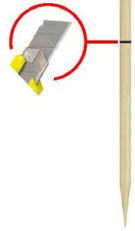

14

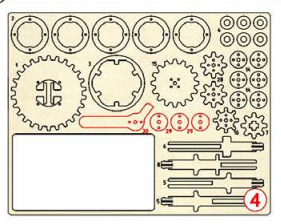
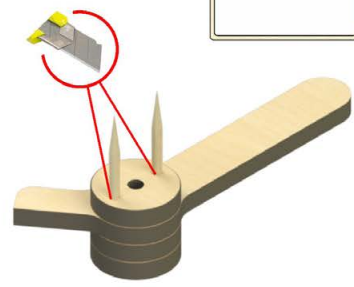
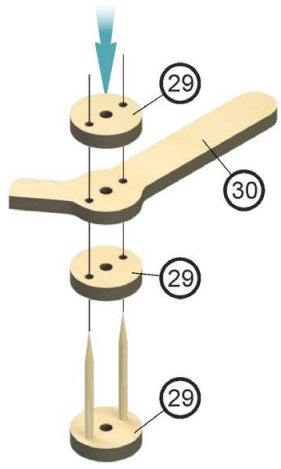
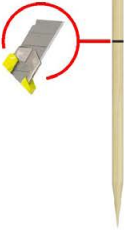

15

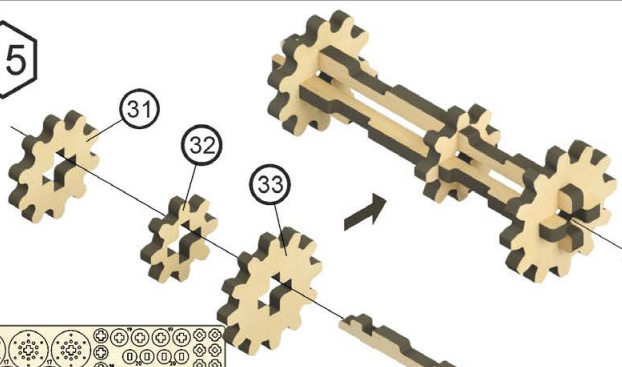
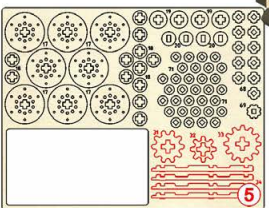

D=6x102

34 x4



16

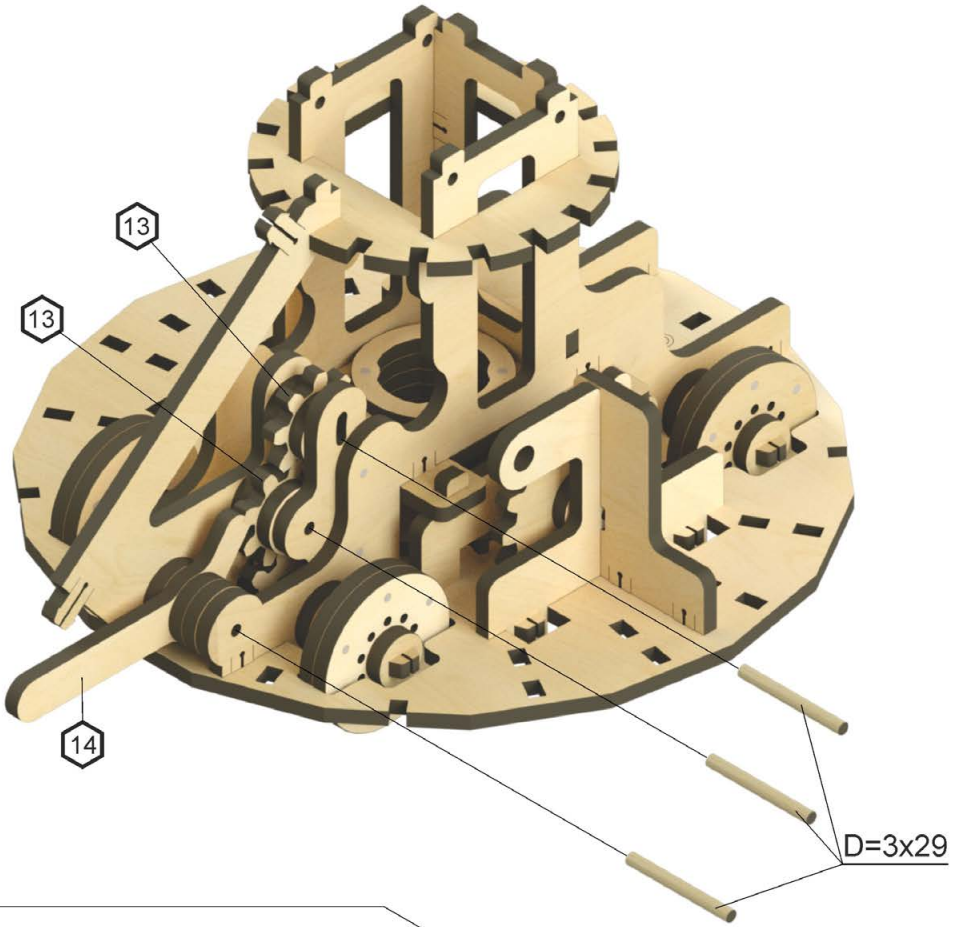

17

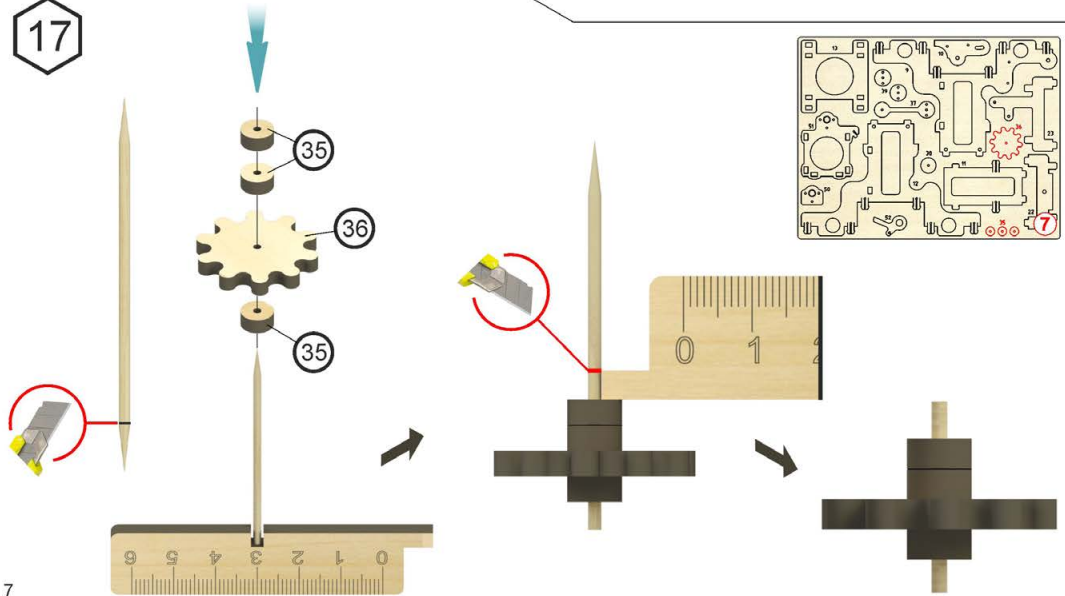

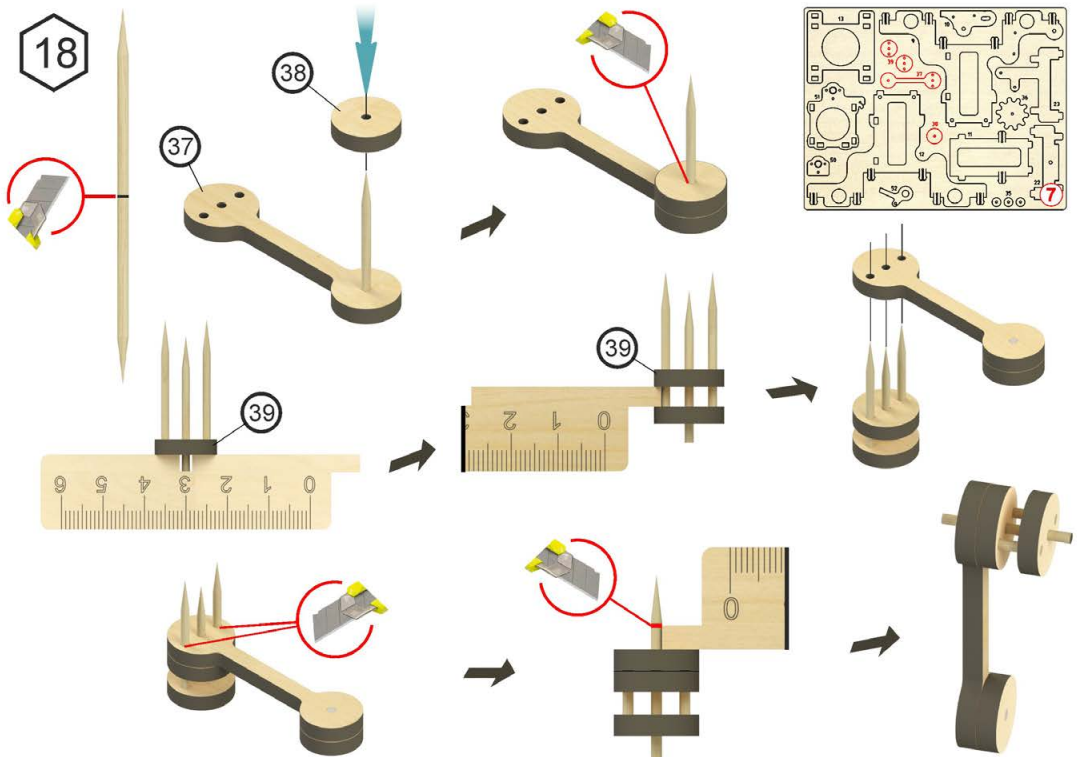

20

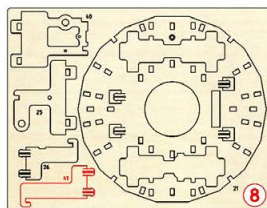
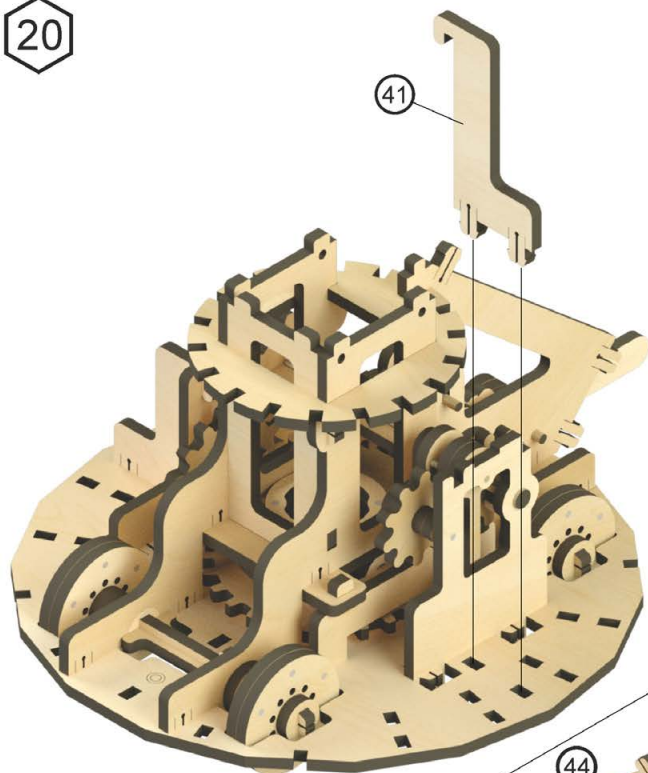

21

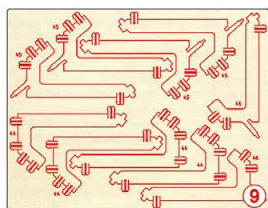
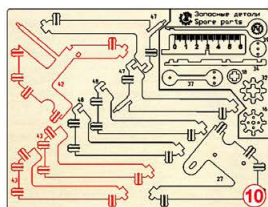
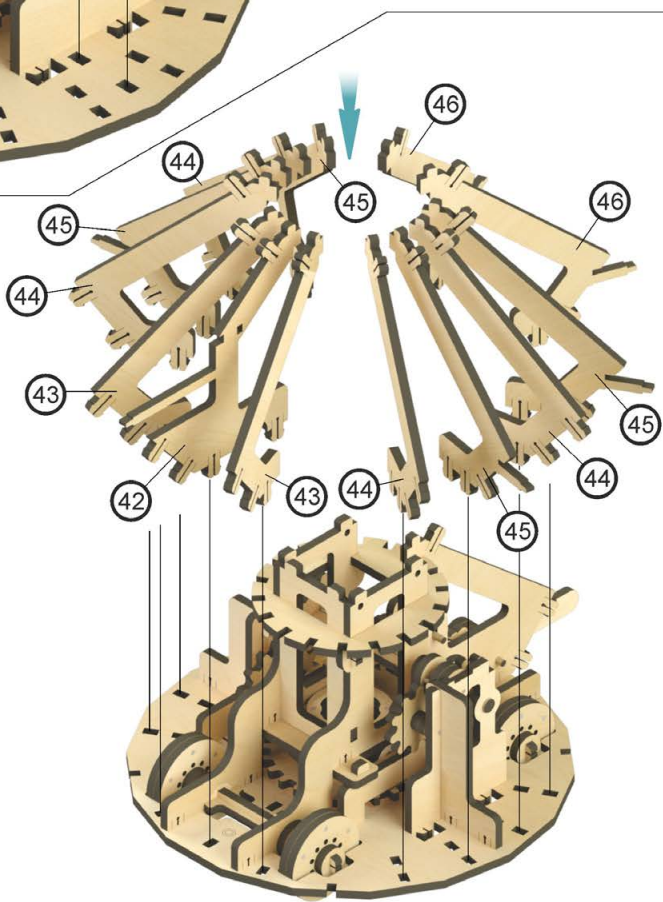

22

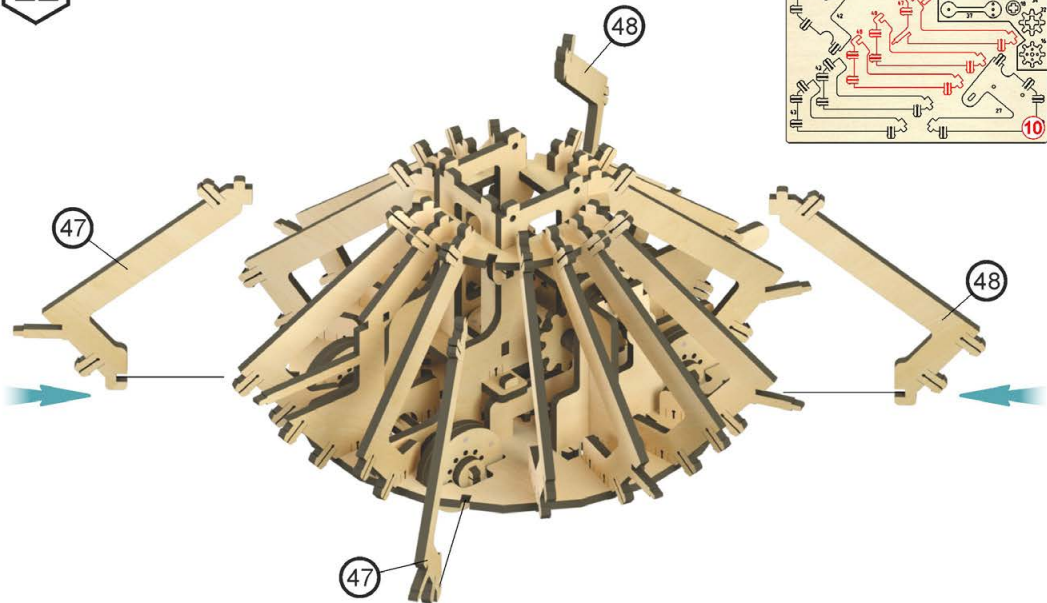

23

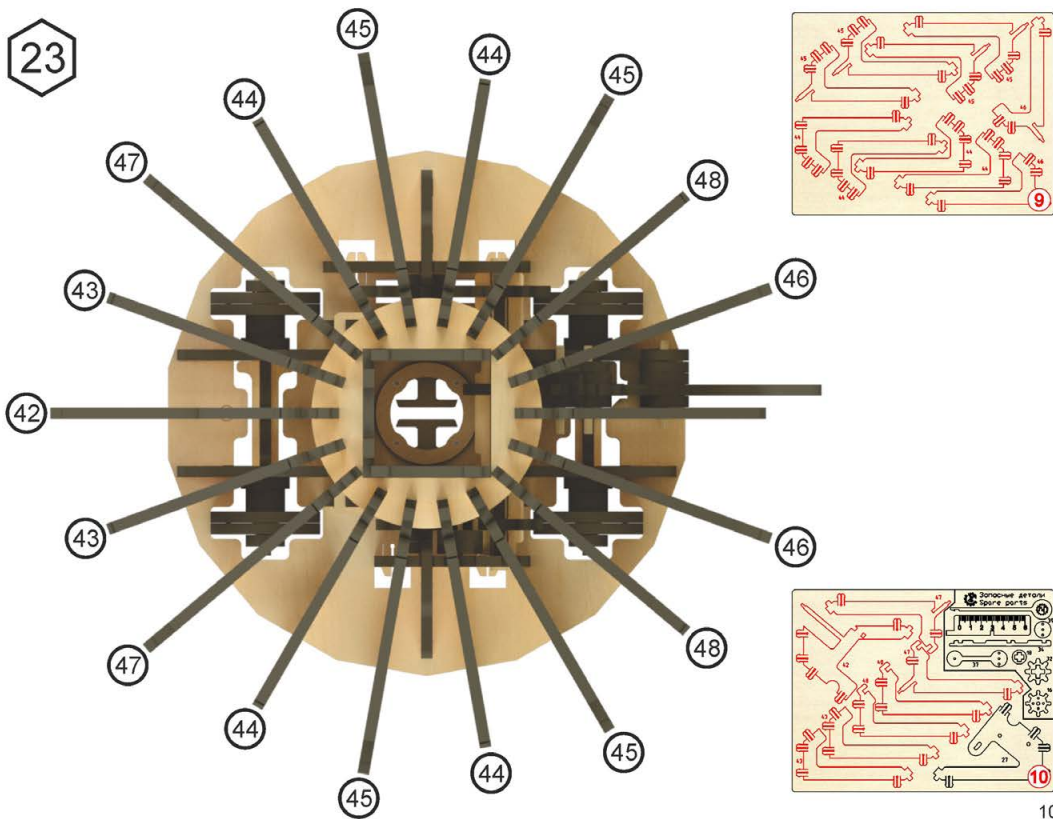

24

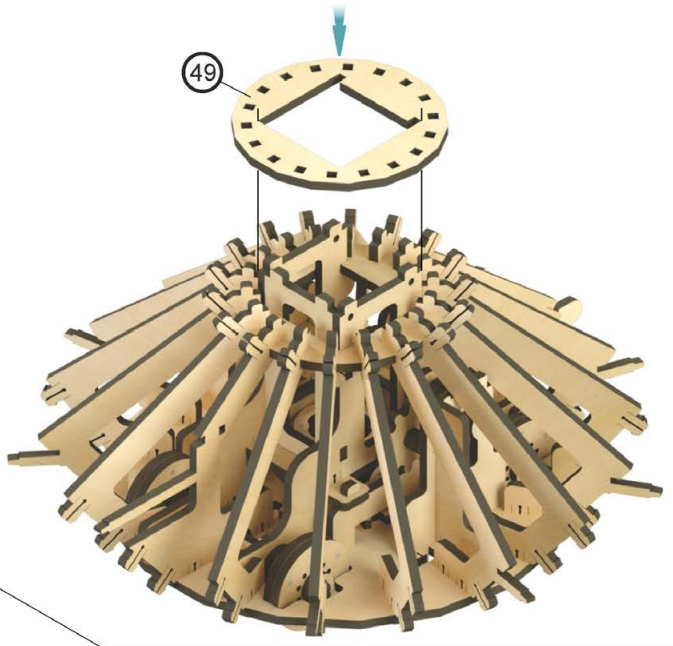
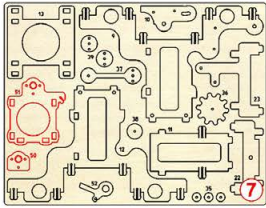
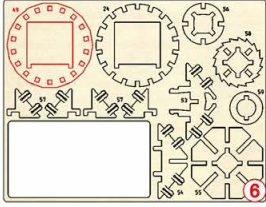

25

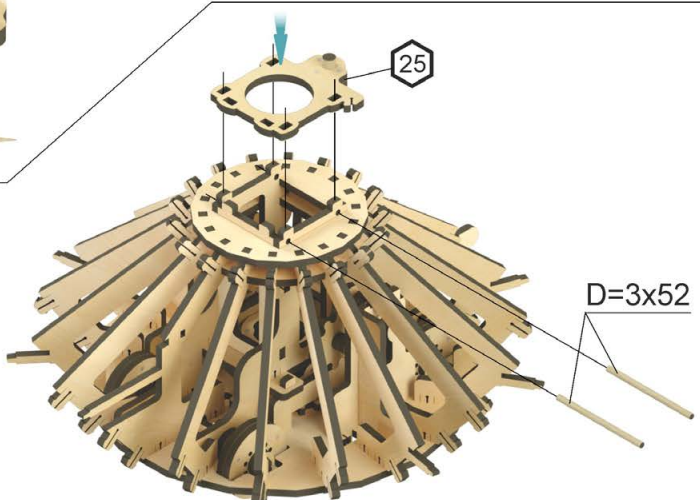
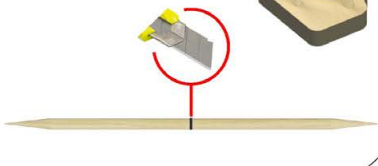
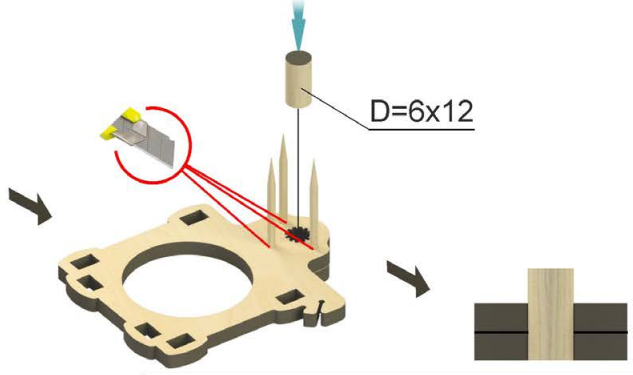
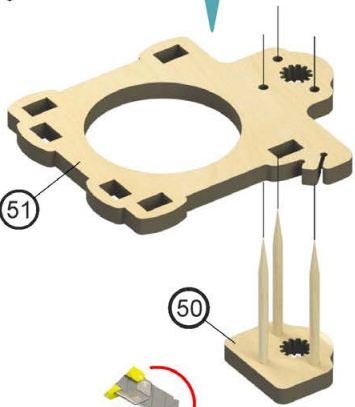

26

27

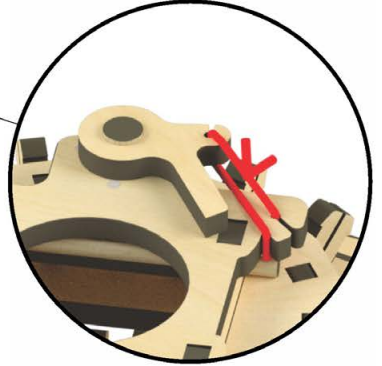
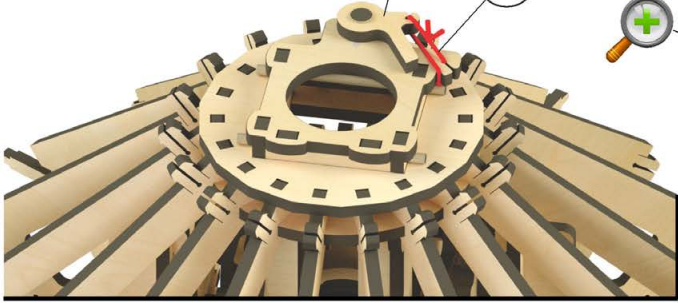
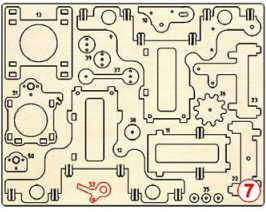

28

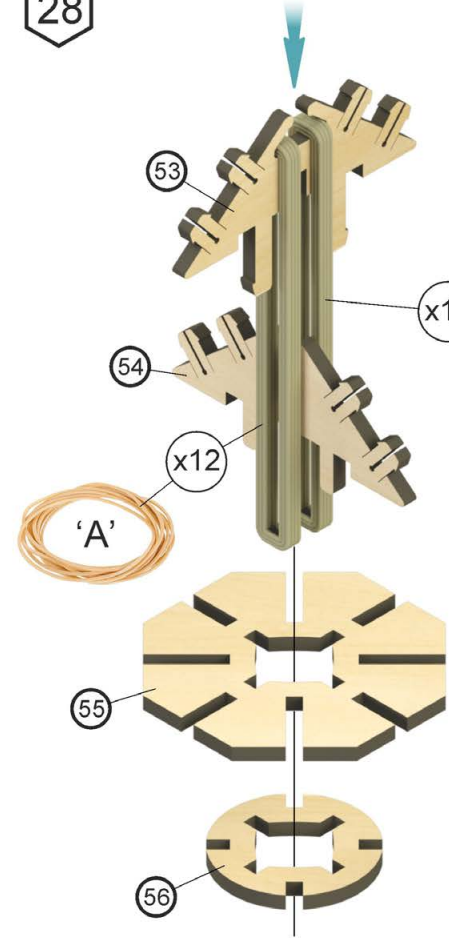
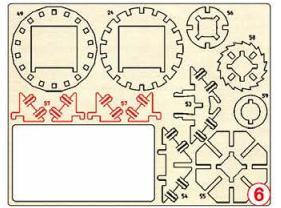
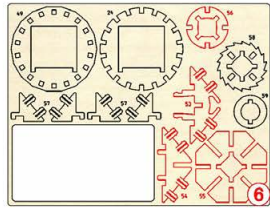

29

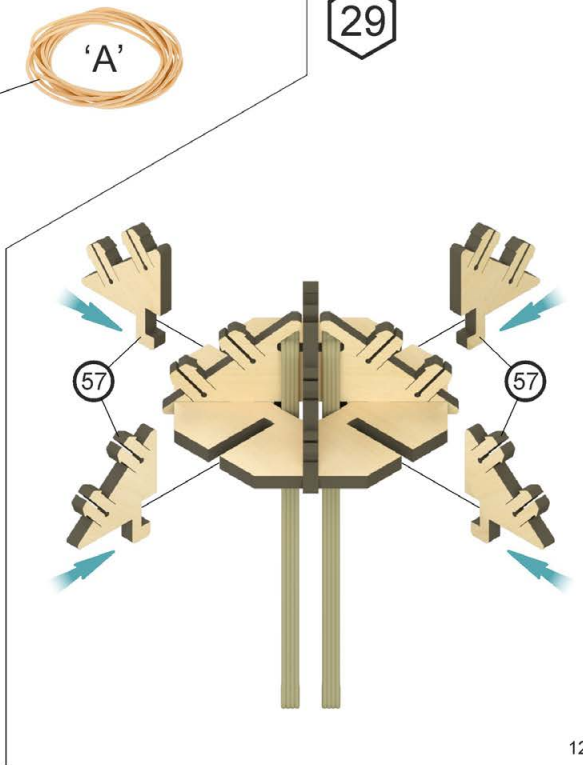

30

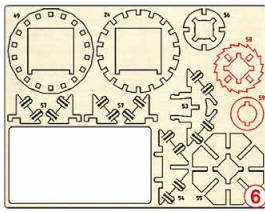

31

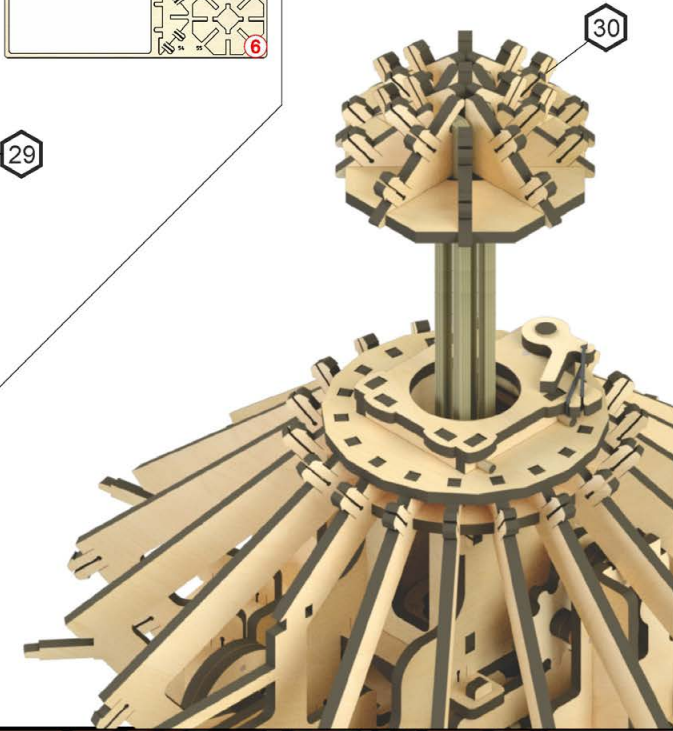
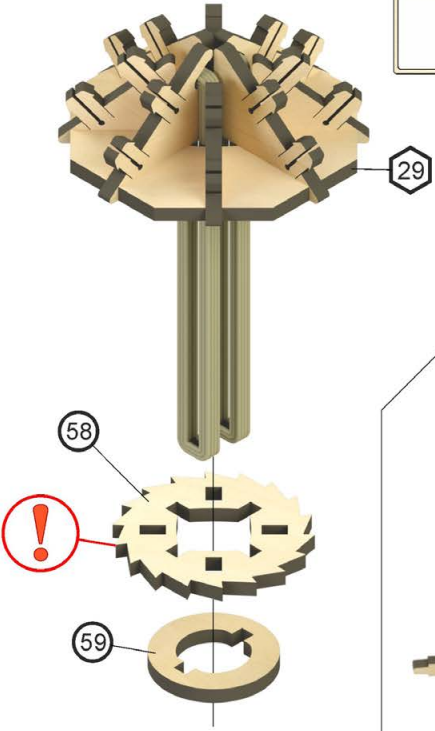

32

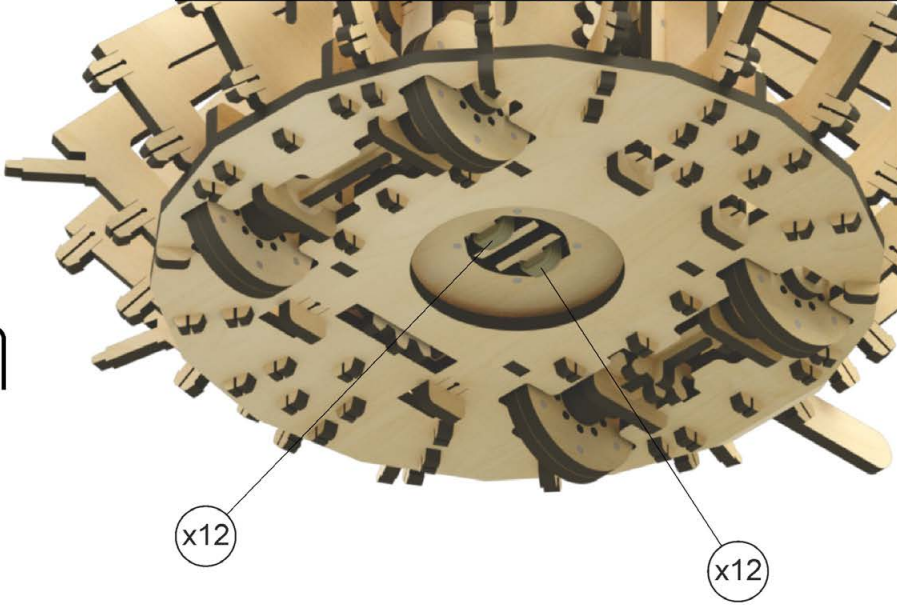
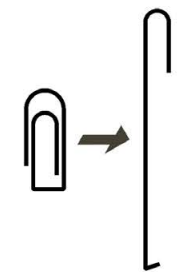

33

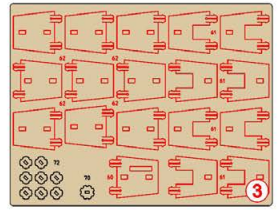
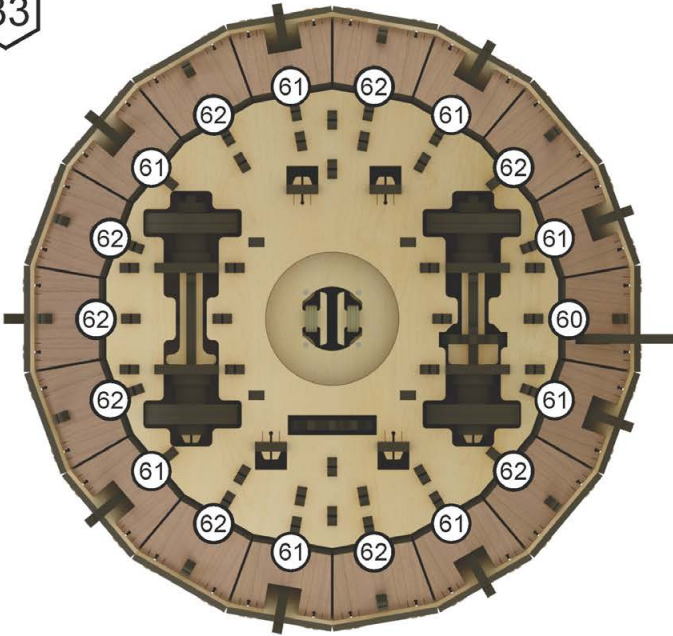

34

