

## ASSEMBLY INSTRUCTION FOR MODEL

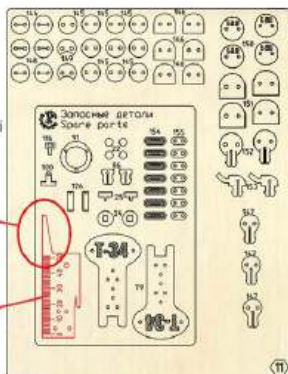

# TANK T-34-85

- EN The ledge is for the squeezing the small details out of the board  
 PL Występ w linijce przeznaczony jest do wyciskania małych detali z arkusza sklejk  
 FR La proéminence est conçue pour aider à presser et enlever les petits détails de la feuille  
 ES La repisa es para apretar los pequeños detalles fuera del tablero  
 DE Der Vorsprung dient dazu, kleine Teile aus den Platten zu drücken  
 RU Выступ предназначен для выдвигания из листа мелких деталей  
 IT Le proiezioni riportate sui fogli di istruzioni sono utili anche nella fase di smontaggio per estrarre i pezzi  
 CZ Použijte k vytlačení malých částí z desky  
 CN 輔助測量尺可幫助取出或緊接細小零件時使用



- EN Use for the change the length  
 PL Stosować do wyznaczenia długości  
 FR Appliquer pour définir la longueur  
 ES Utilizar para determinar la longitud  
 DE Zur Änderung der Länge verwenden  
 RU Использовать для определения длины  
 IT Usare per determinare la lunghezza  
 CZ Použijte pro změnění délky  
 CN 用它来 测量长度

- EN Rubber bands  
 PL Gumki recepturki  
 FR Des élastiques  
 ES Gomas elásticas  
 DE Gummibänder  
 RU Резинки  
 IT Elastici  
 CZ Gumičky  
 CN 枚橡皮筋



- EN Cut it with a razor blade  
 PL Odetnij nożem do kopert  
 FR Couper avec un cutter  
 ES Cortar con un bisturí  
 DE Mit Rasierklinge durchschneiden  
 DE Обрезать канцелярским ножом  
 IT Tagliare con un coltello da cancelleria  
 CZ Vyřizněte řezákem  
 CN 用刀片切斷



- EN Remove the burrs with sandpaper  
 PL Usunąć zadziory papierem ściernym  
 FR Retirer les bavures avec du papier à polir  
 ES Quitar las rebabas con el papel esmeril  
 DE Grate mit Schleifpapier entfernen  
 RU Удалить заусенцы наждачной бумагой  
 IT Sbravare con carta vetrata  
 CZ Vyhlaďte smirkových papírem  
 CN 用砂紙去除毛刺。



- EN Details should rotate freely  
 PL Swobodne obracanie  
 FR Libre rotation  
 ES Rotación libre  
 DE Auf freie Rotation achten  
 RU Свободное вращение  
 IT Rotazione libera  
 CZ Části by se měly volně otáčet  
 CN 流暢地旋轉



- EN Wax it with a candle  
 PL Posmaruj za pomocą świecy parafinowej  
 FR Graisser avec une bougie de paraffine  
 ES Engrasar con ayuda de una vela de parafina  
 DE Mit einer Kerze wachsen  
 RU Смазать парафиновой свечой  
 IT Lubrificare con candela di paraffina  
 CZ Navoskujte svíčkou  
 CN 用干蠟燭上蠟潤滑



- EN Pay attention  
 PL Uwaga  
 FR Prête attention  
 ES Prestar atención  
 DE Achtung  
 RU Уделить внимание  
 IT Prestare attenzione  
 CZ Pozor  
 CN 请注意

EN The manufacturer reserves the right to make changes in the design of the product, not worsening its technical characteristics. Information about the changes made may not be present in this manual.

PL Producent zastrzega sobie prawo do zmiany konstrukcji wyrobu bez pogorszenia jego właściwości technicznych. Niniejsza instrukcja może nie zawierać informacji o zmianach.

FR Le producteur se réserve le droit d'apporter des modifications dans la construction du produit à condition si elles ne portent atteinte à ses caractéristiques techniques. Les renseignements sur les modifications apportées peuvent ne pas être dans la présente notice.

ES El fabricante se reserva el derecho de introducir modificaciones en la construcción del producto, que no empeoran sus características técnicas. Datos sobre modificaciones introducidas pueden no aparecer en esta instrucción.

DE Der Hersteller behält sich das Recht auf Designänderungen, die die technischen Merkmale und Funktionen nicht negativ beeinflussen, vor.

RU Производитель оставляет за собой право вносить изменения в конструкцию изделия, не ухудшающие его технические характеристики. Сведения о внесенных изменениях могут отсутствовать в настоящей инструкции.

IT Il produttore si riserva il diritto di apportare modifiche al design del prodotto, non peggiorando le sue caratteristiche tecniche. Informazioni sulle modifiche apportate potrebbero non essere presenti in questo manuale.

CZ Výrobce si vyhrazuje právo na takové změny v designu produktu, které nebudou mít za následek zhoršení technických vlastností. Informace o změnách nemusí být v návodu uvedeny.

CN 製造商保留對產品設計更改的權利，一切改良旨在增強產品的技術性能。改良處若未出現在手冊中，敬請諒解

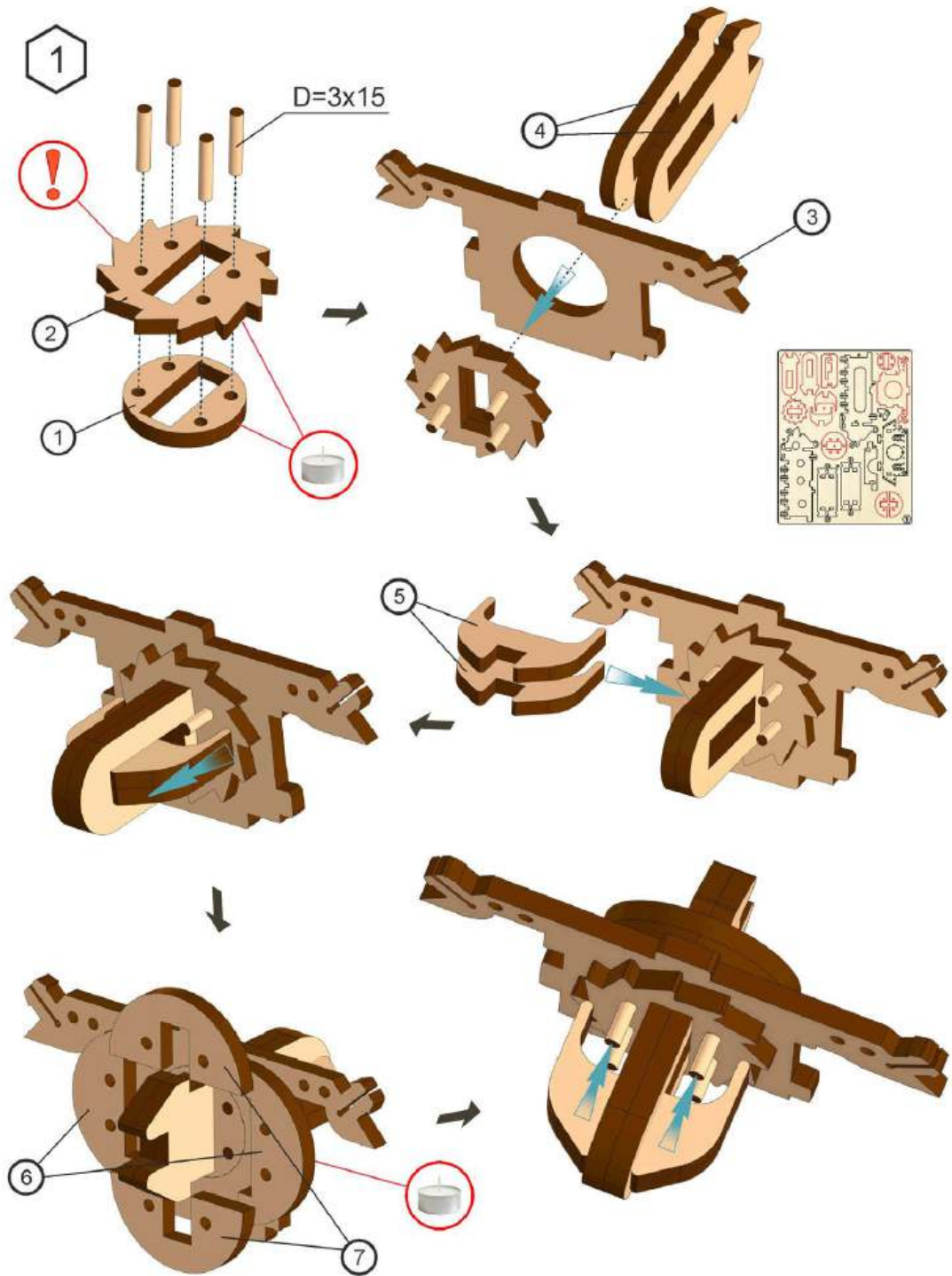

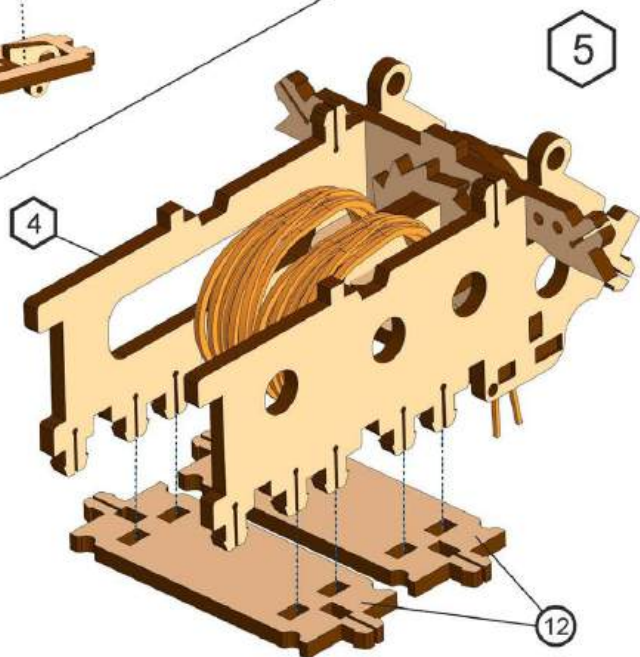
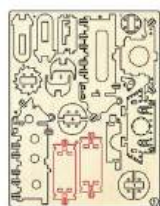
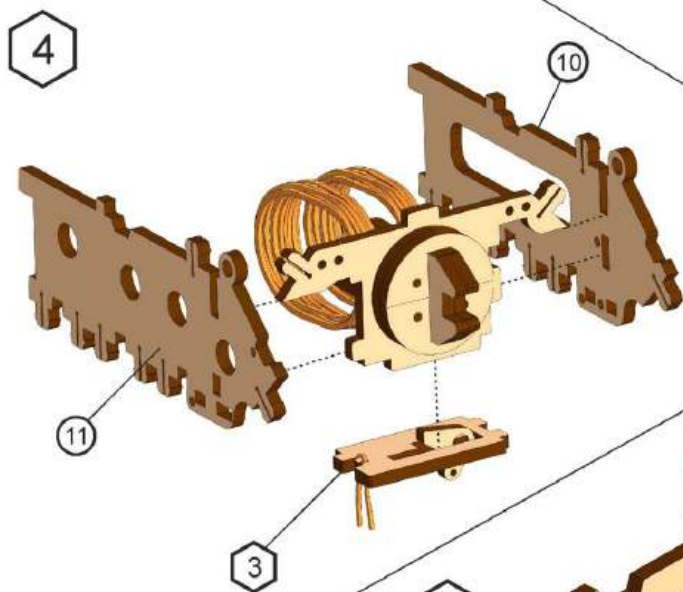
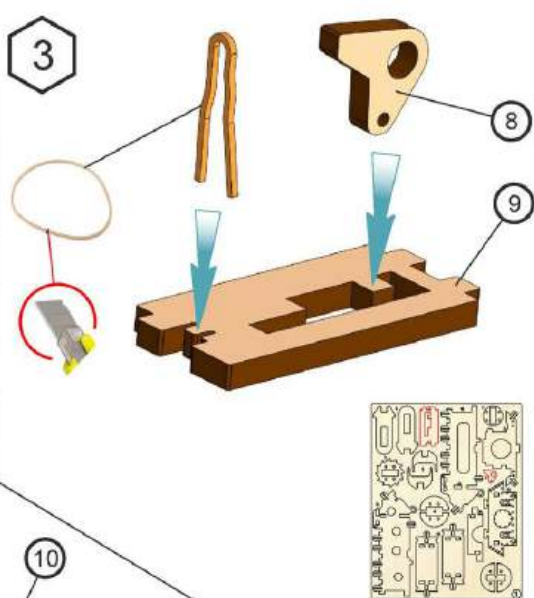
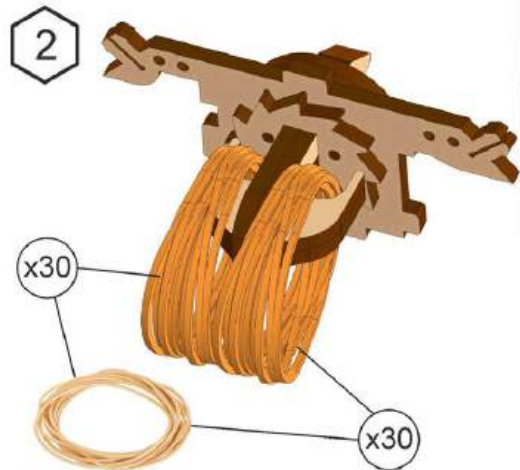

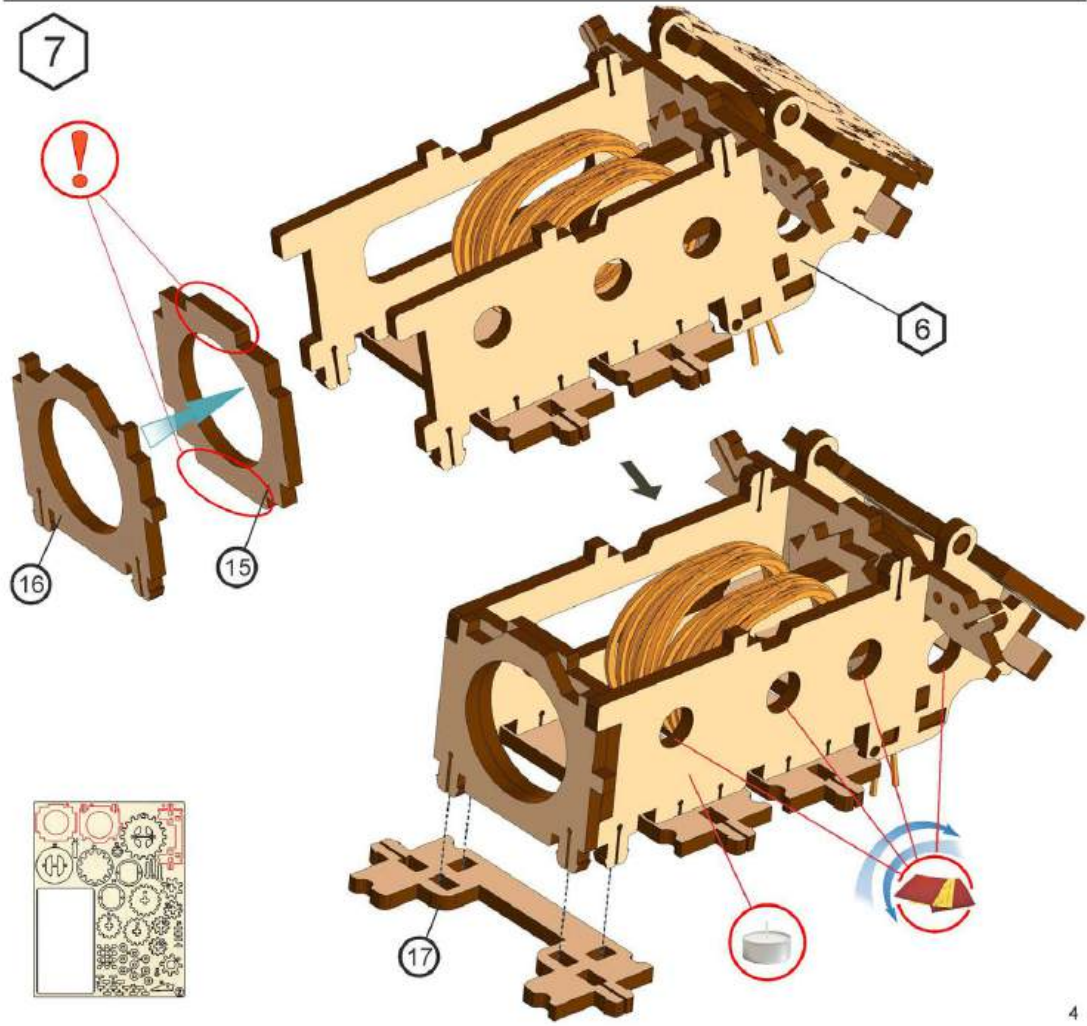
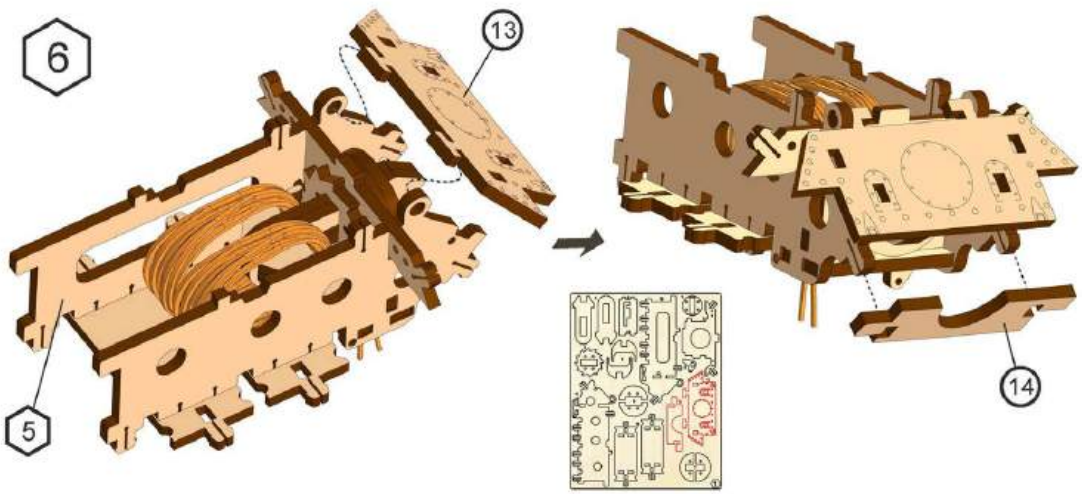

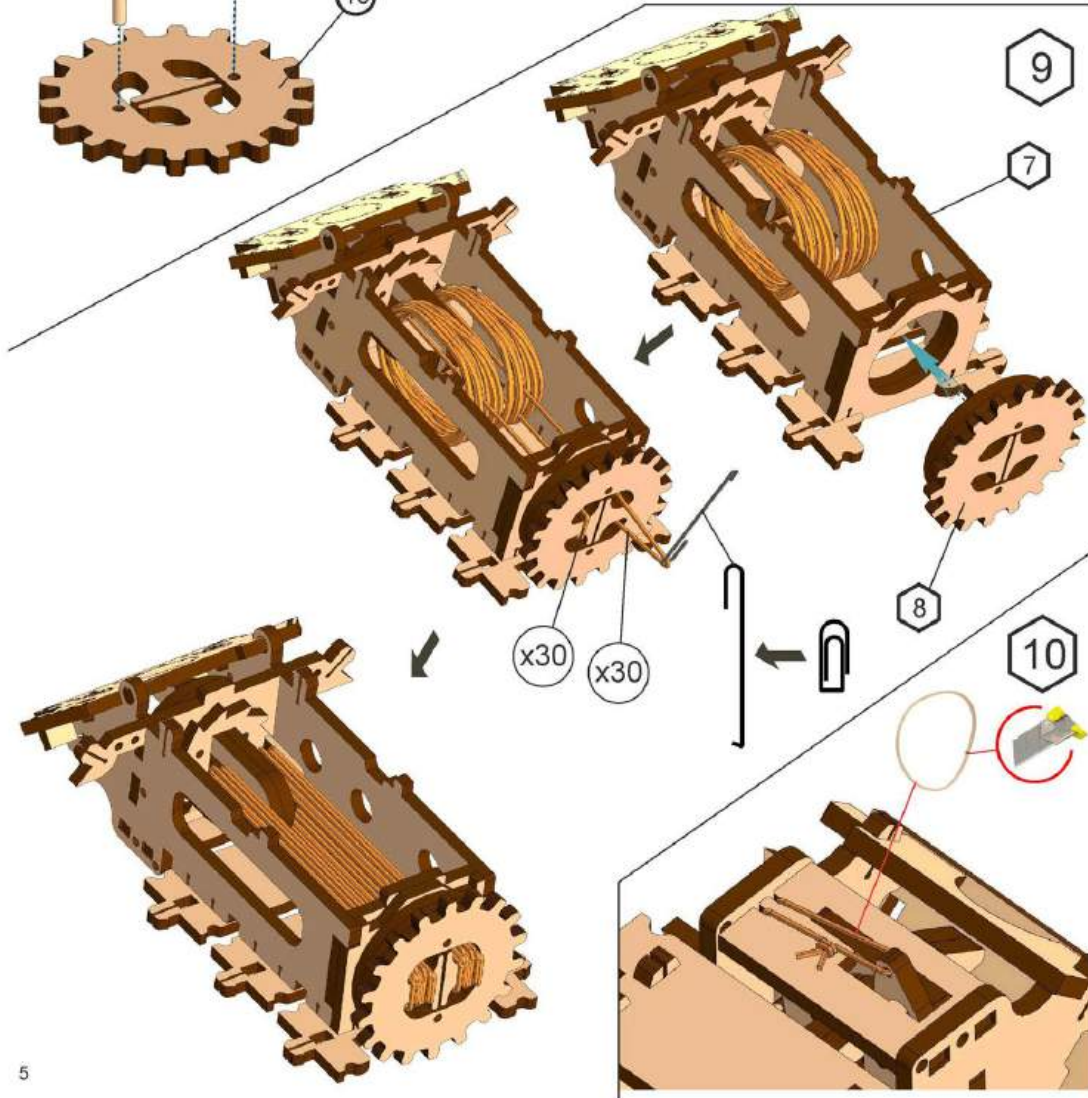
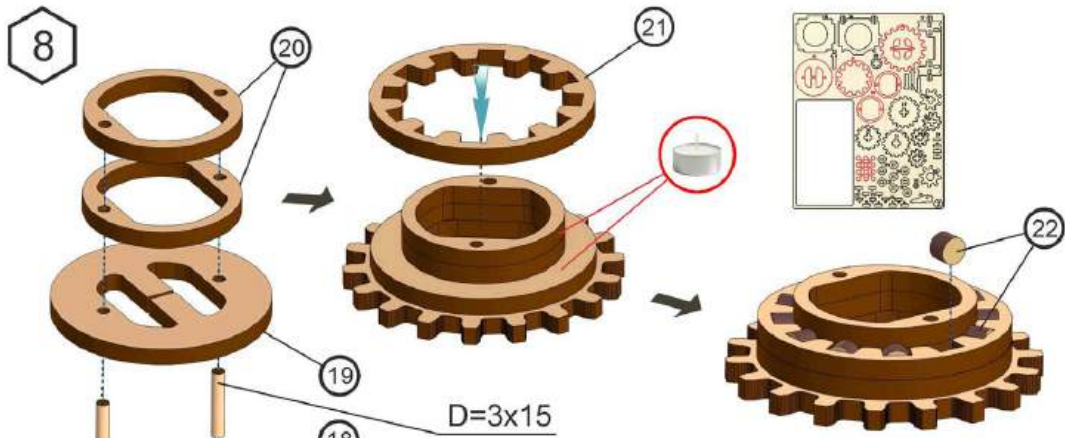

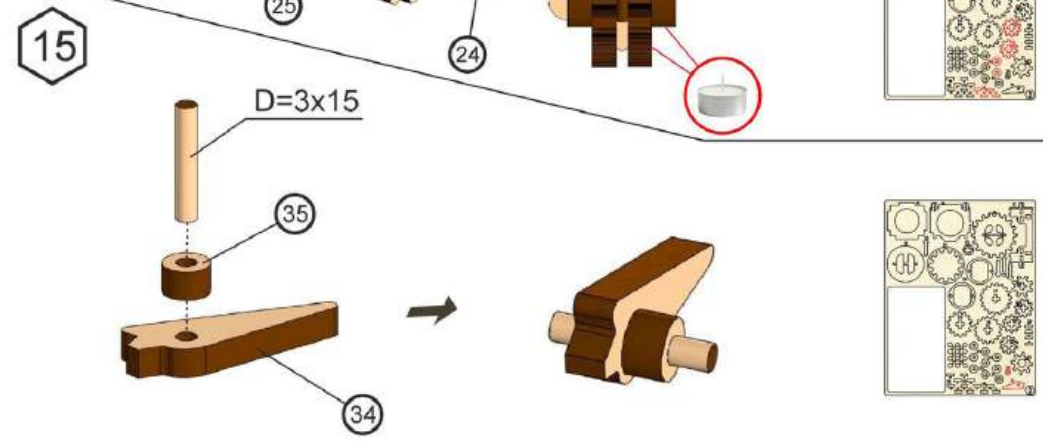
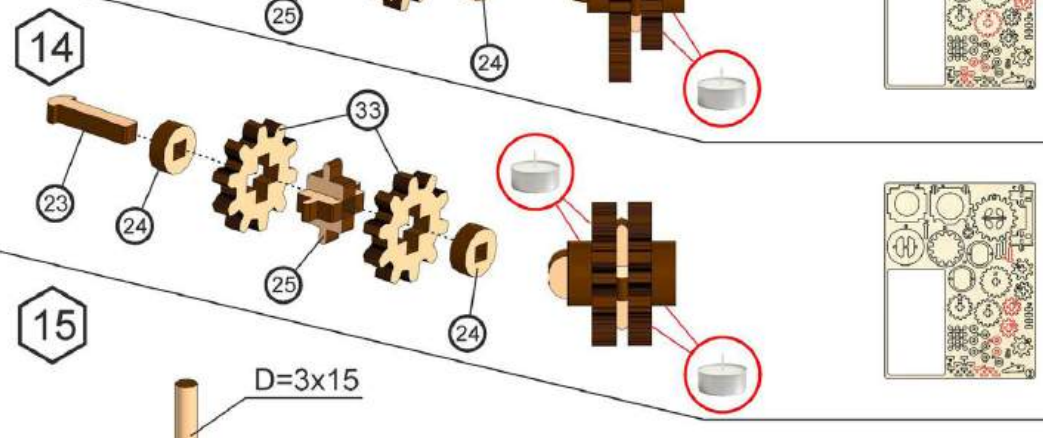
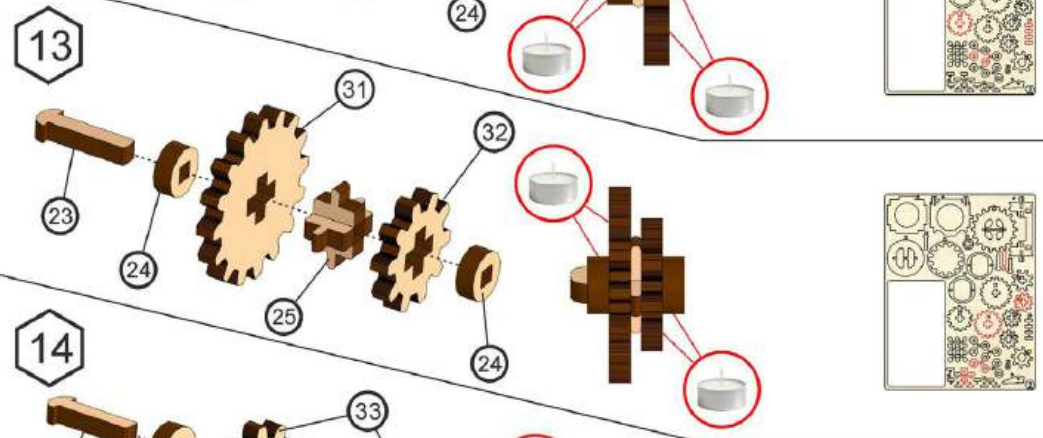
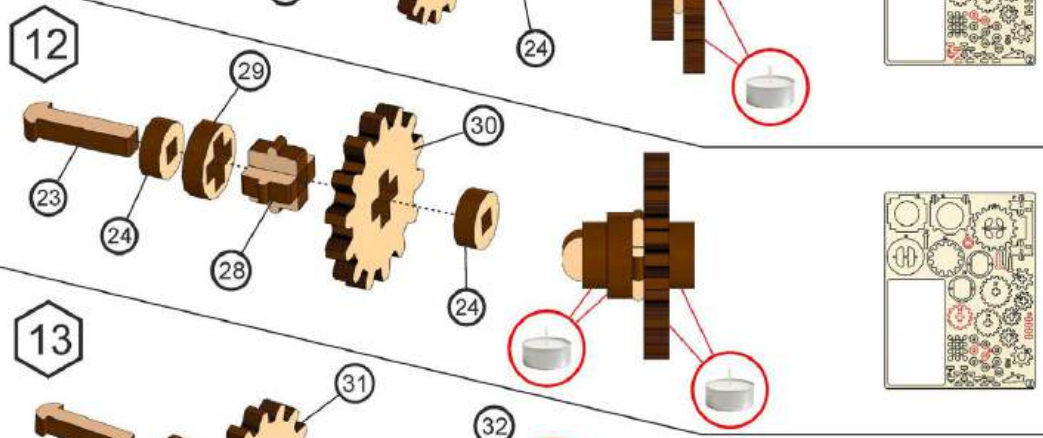
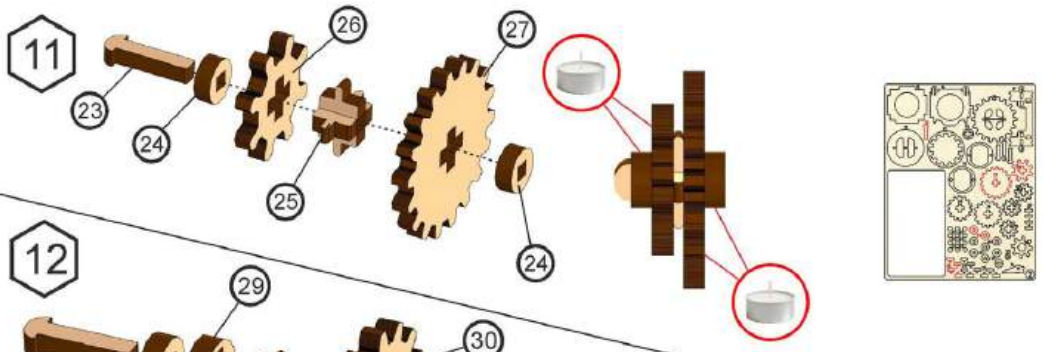

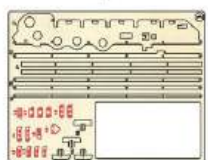
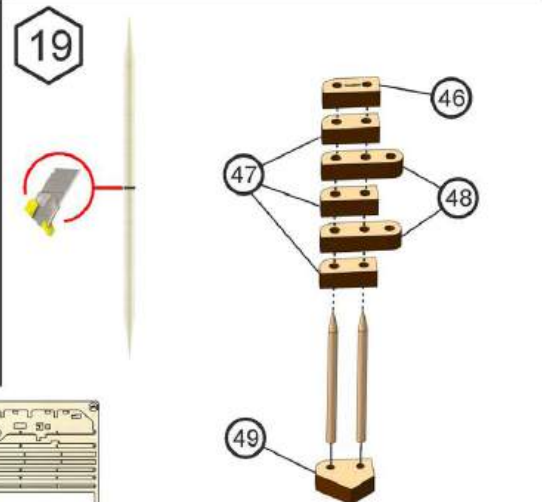
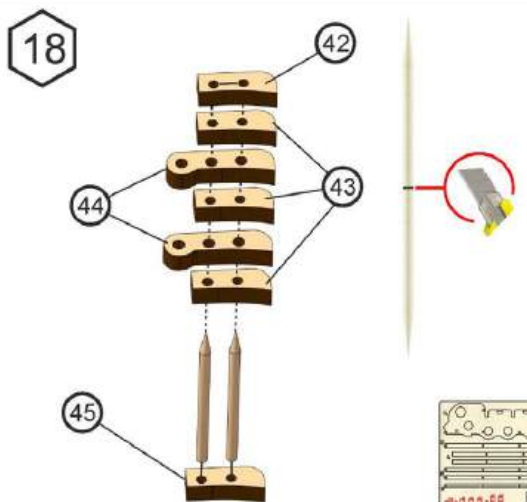
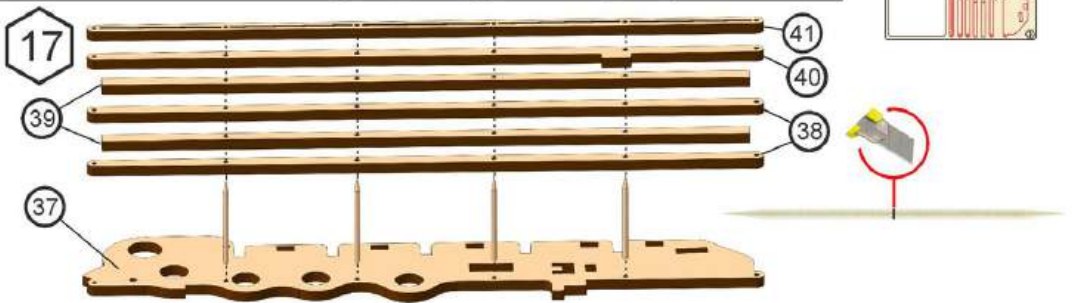
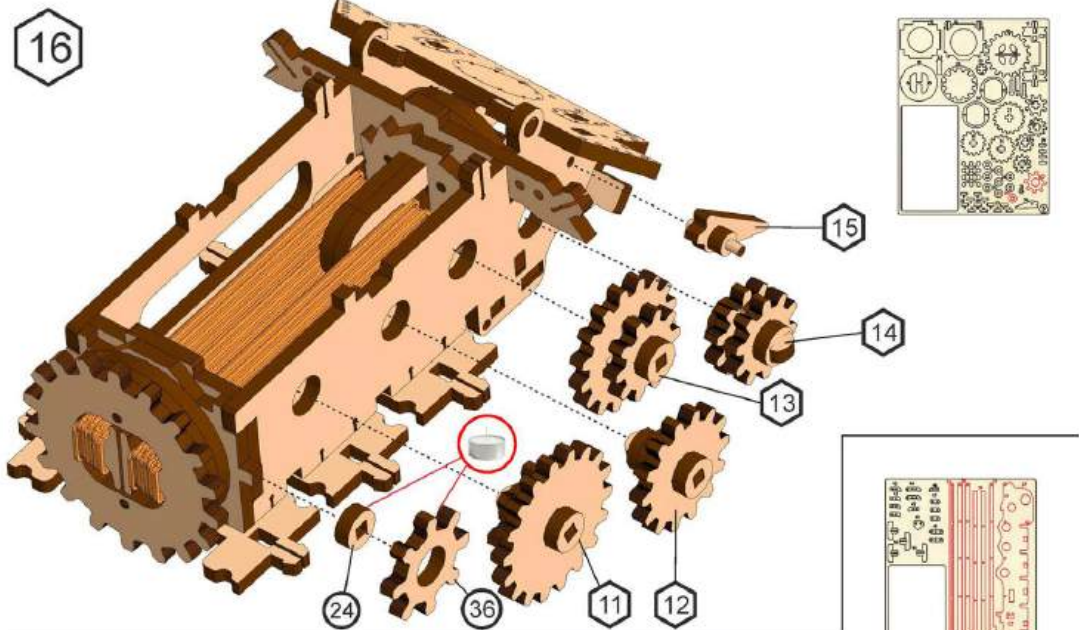

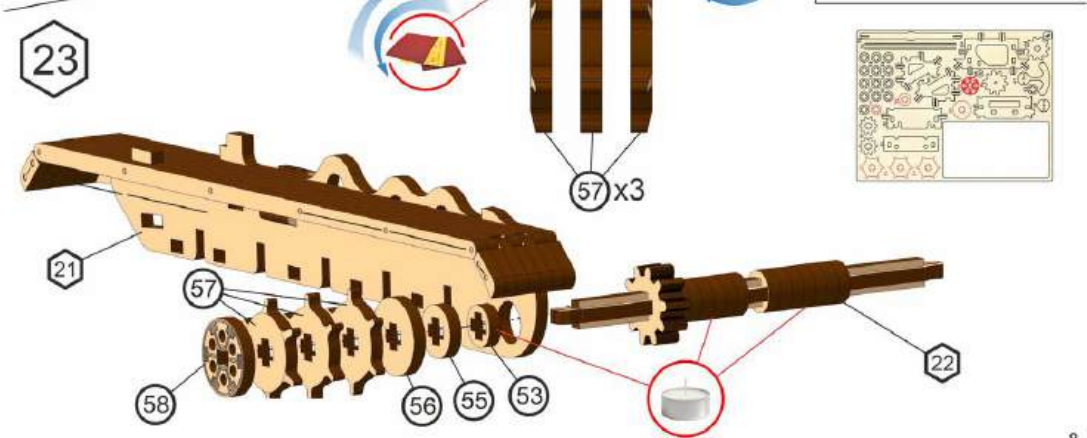
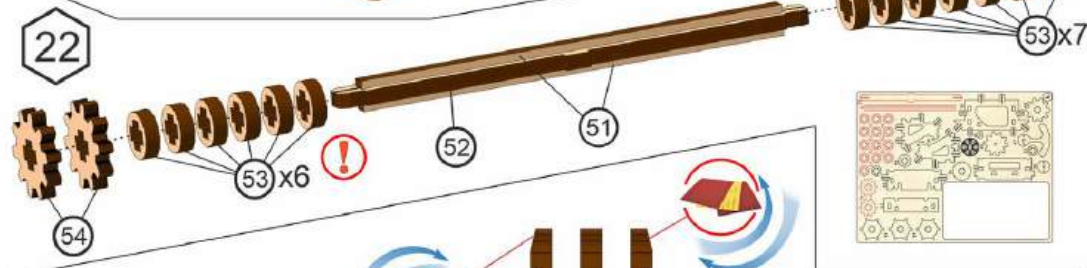
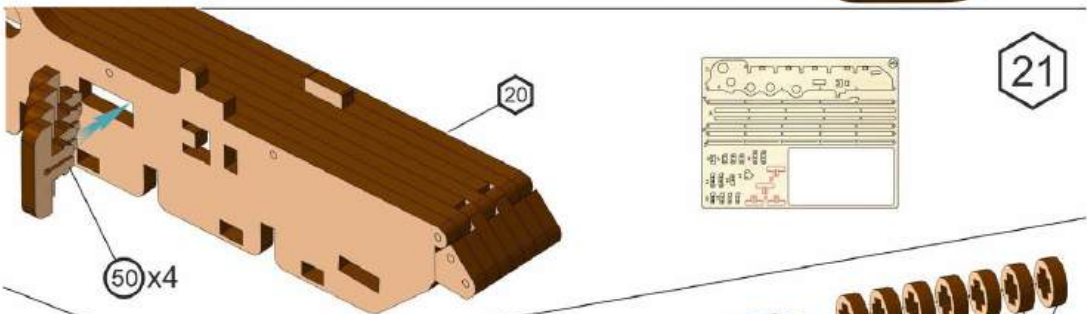
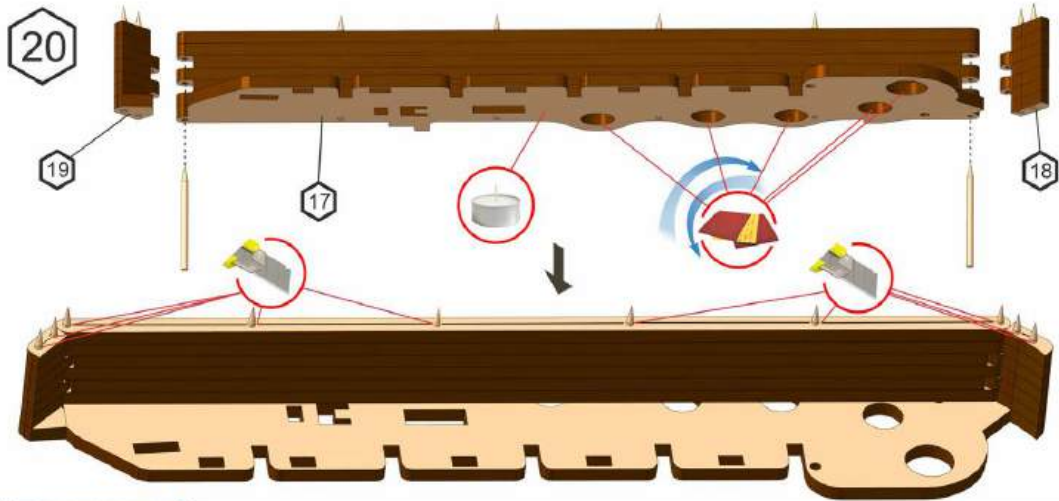

24

23

16

25



59

60

63

62

61

25

24

26

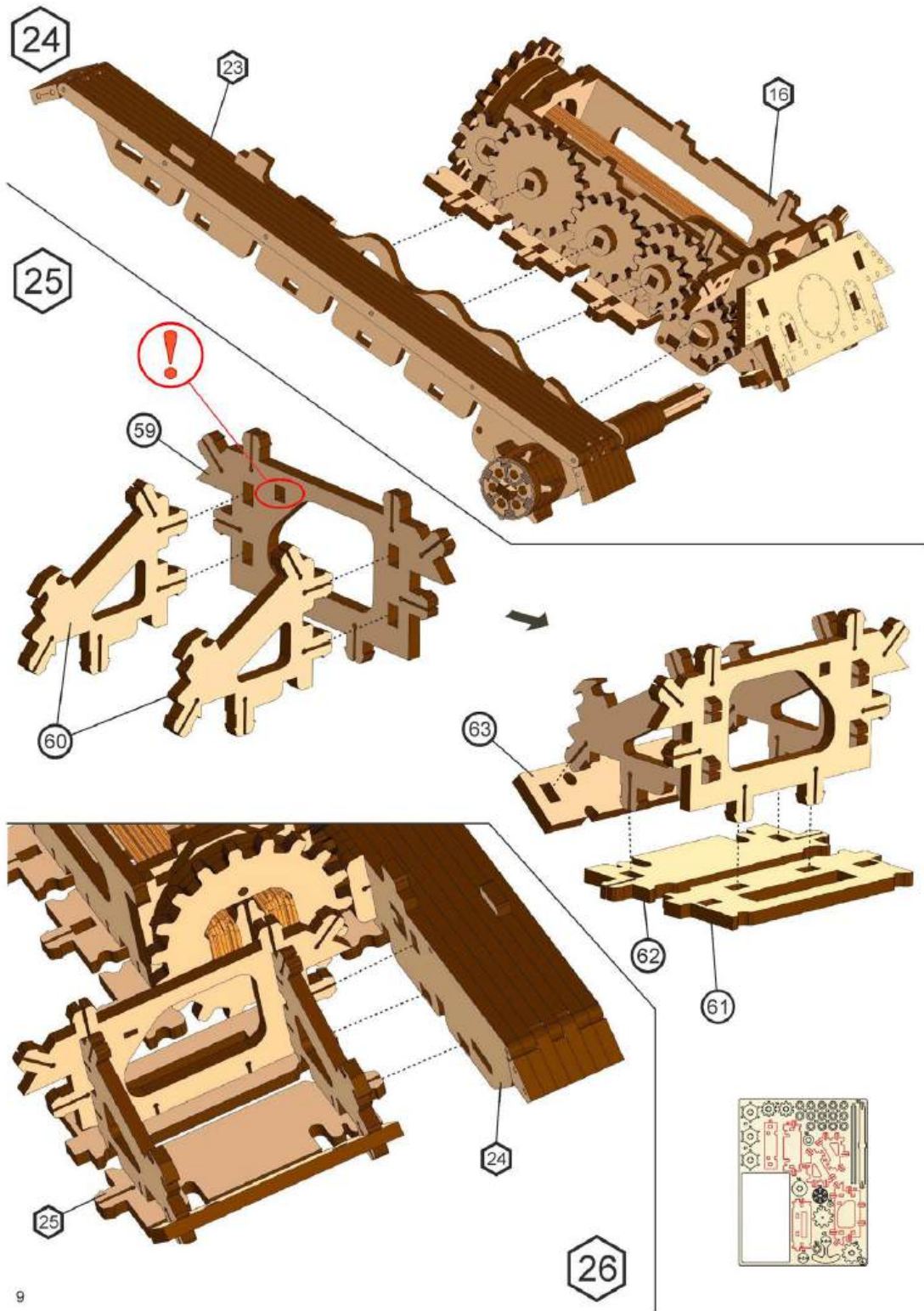
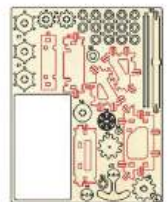

27

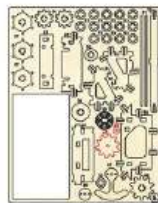
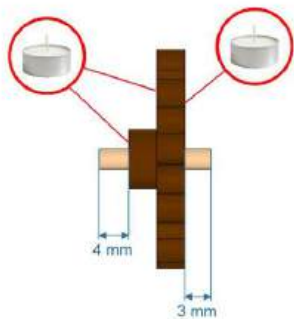
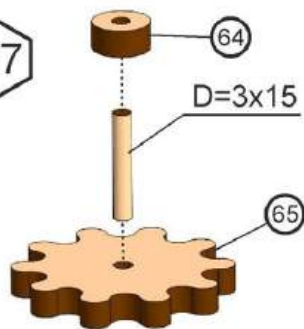

28

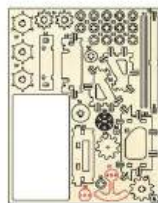
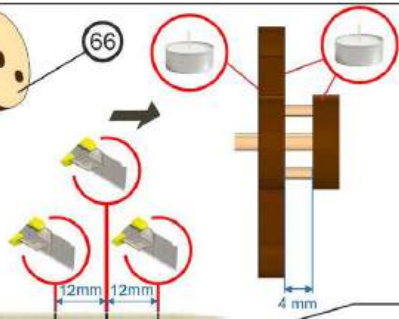
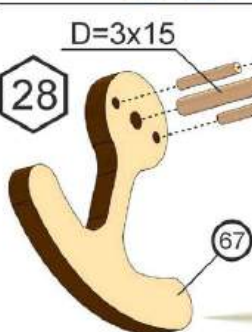

29

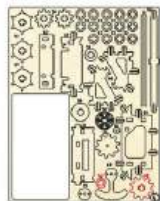
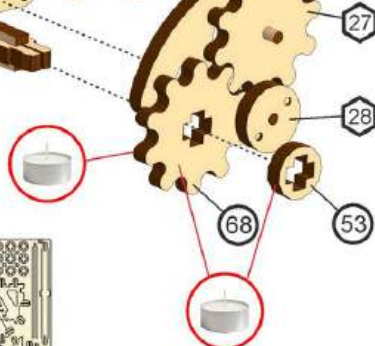
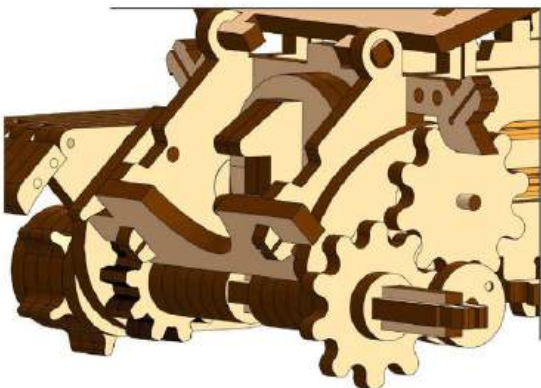
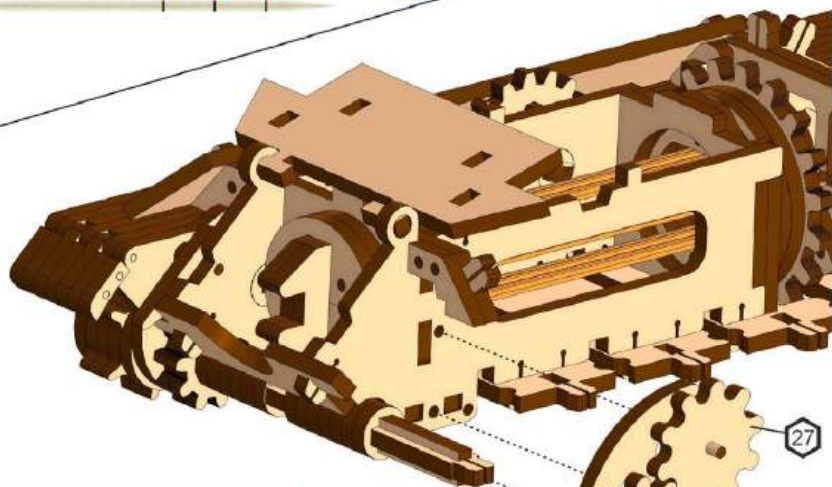

30

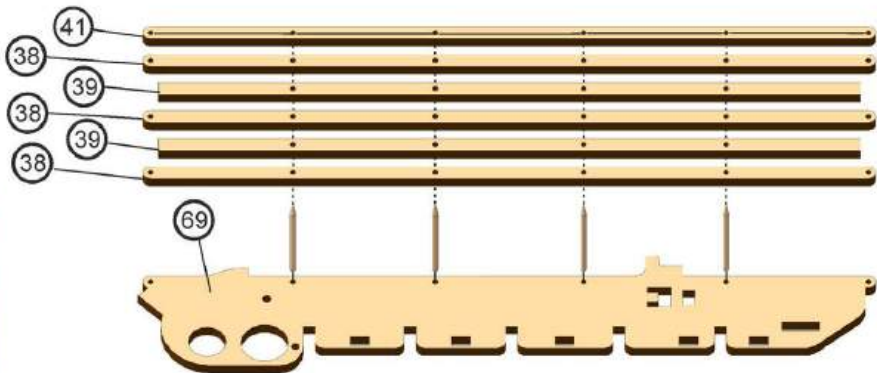
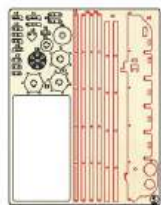

31

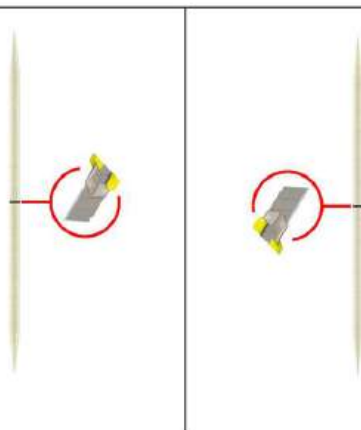
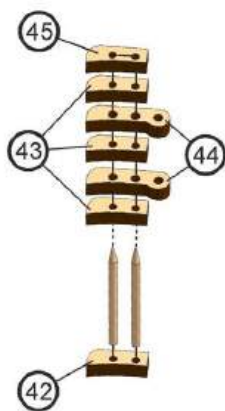

32

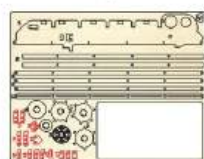
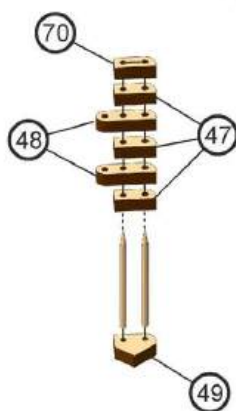

33

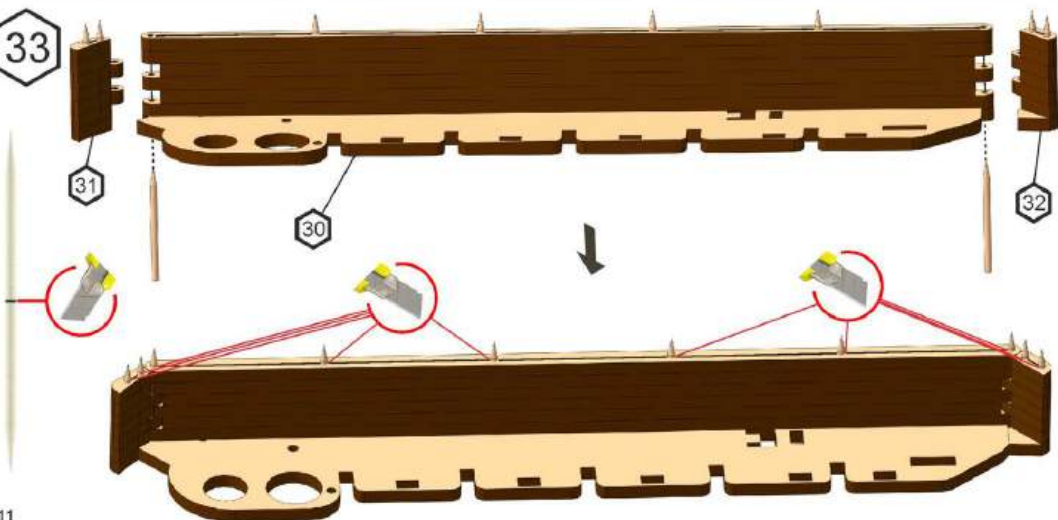

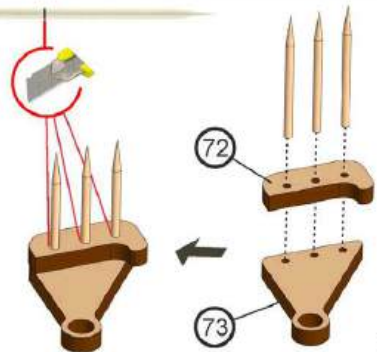
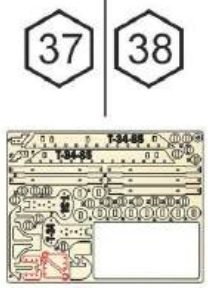
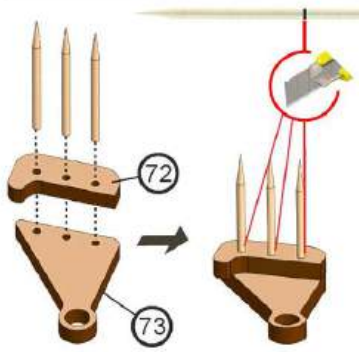
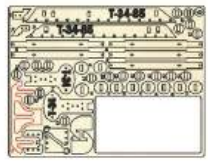
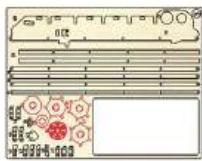
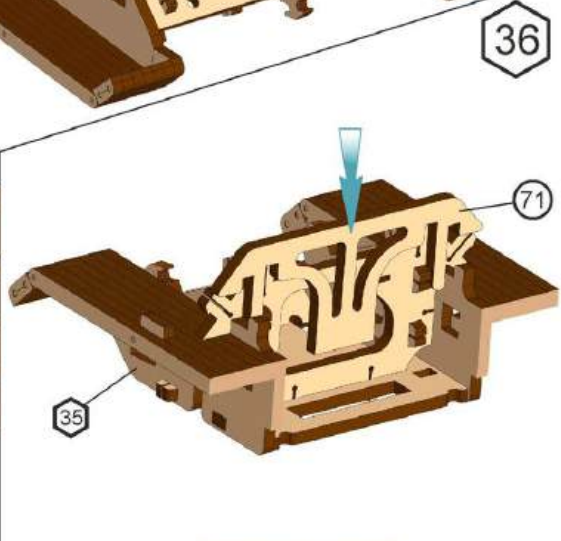
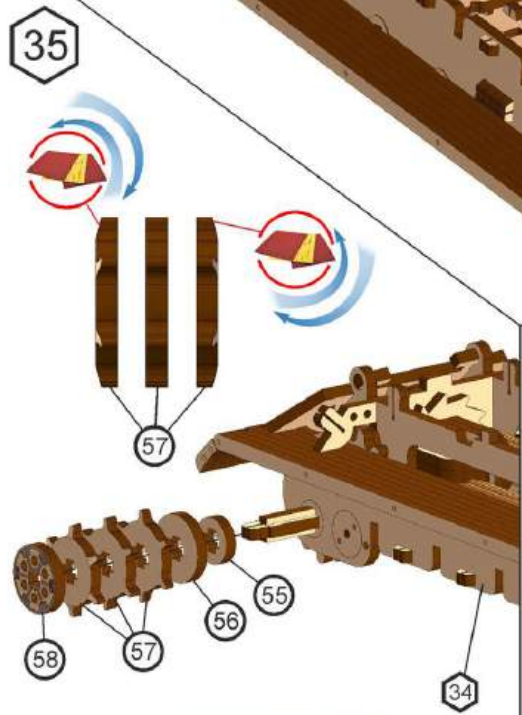
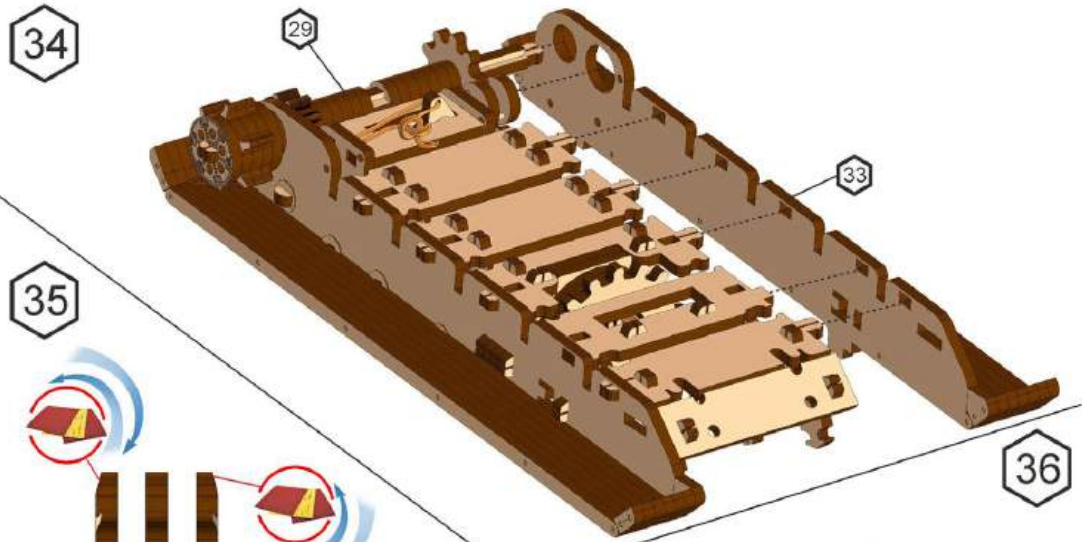

39

37

38

36



74

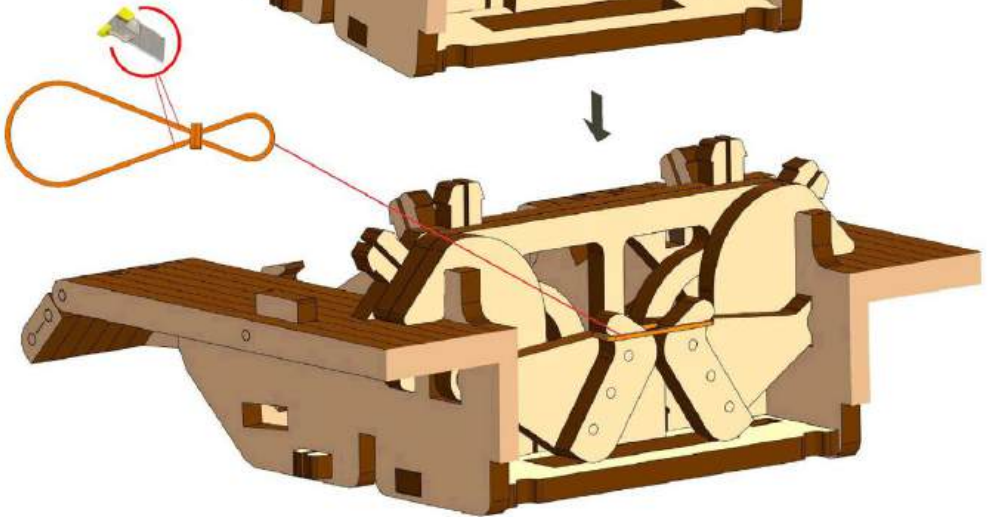

40



39

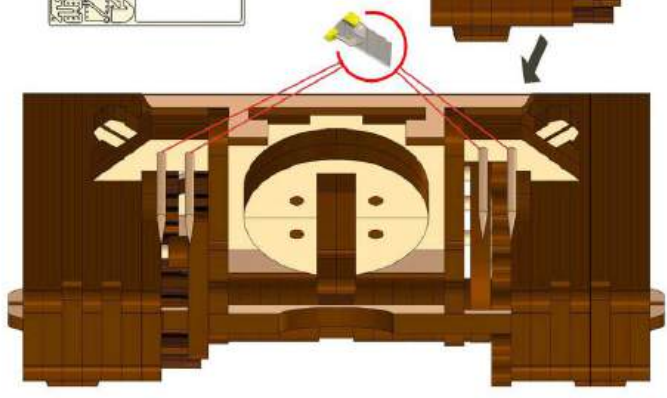
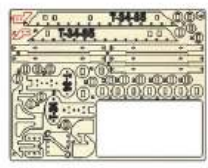
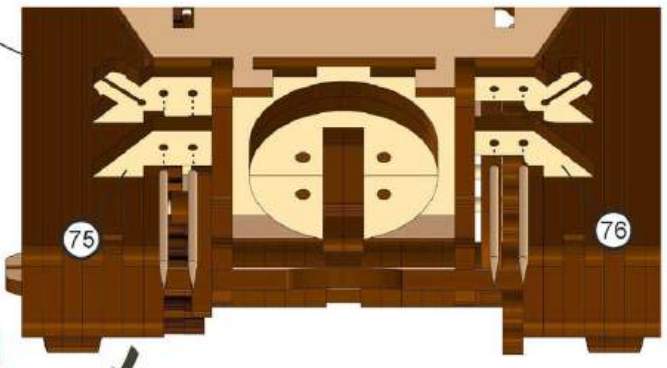

42

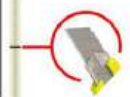
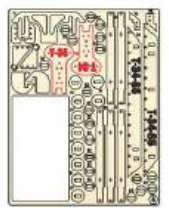

41

78

40

77

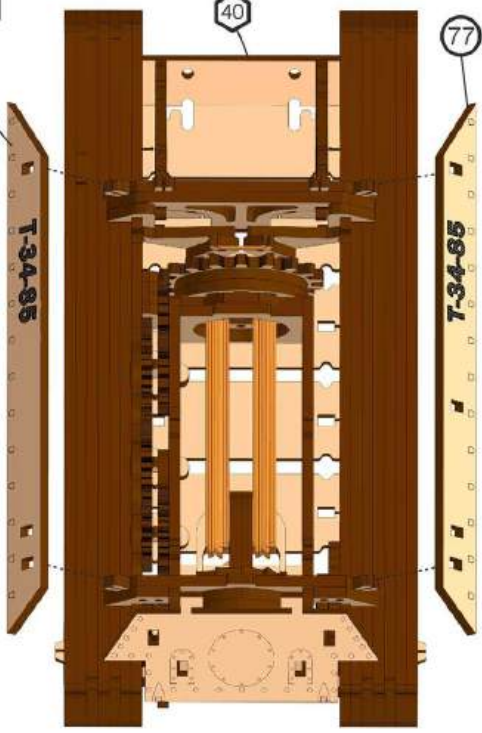

79

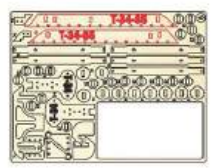
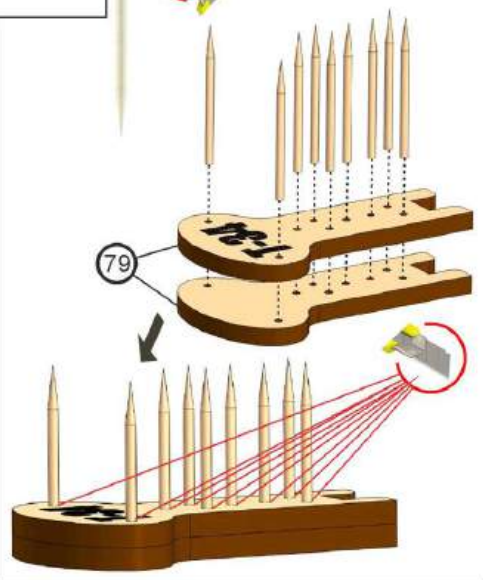

43

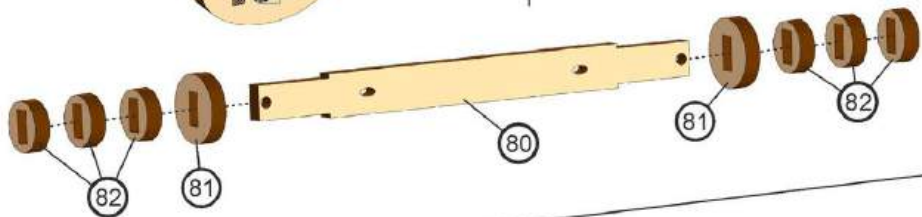
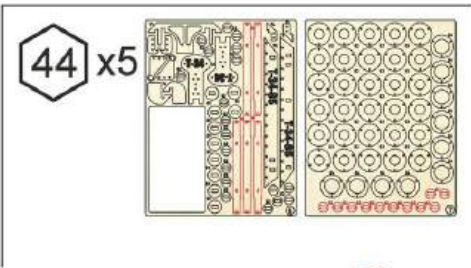
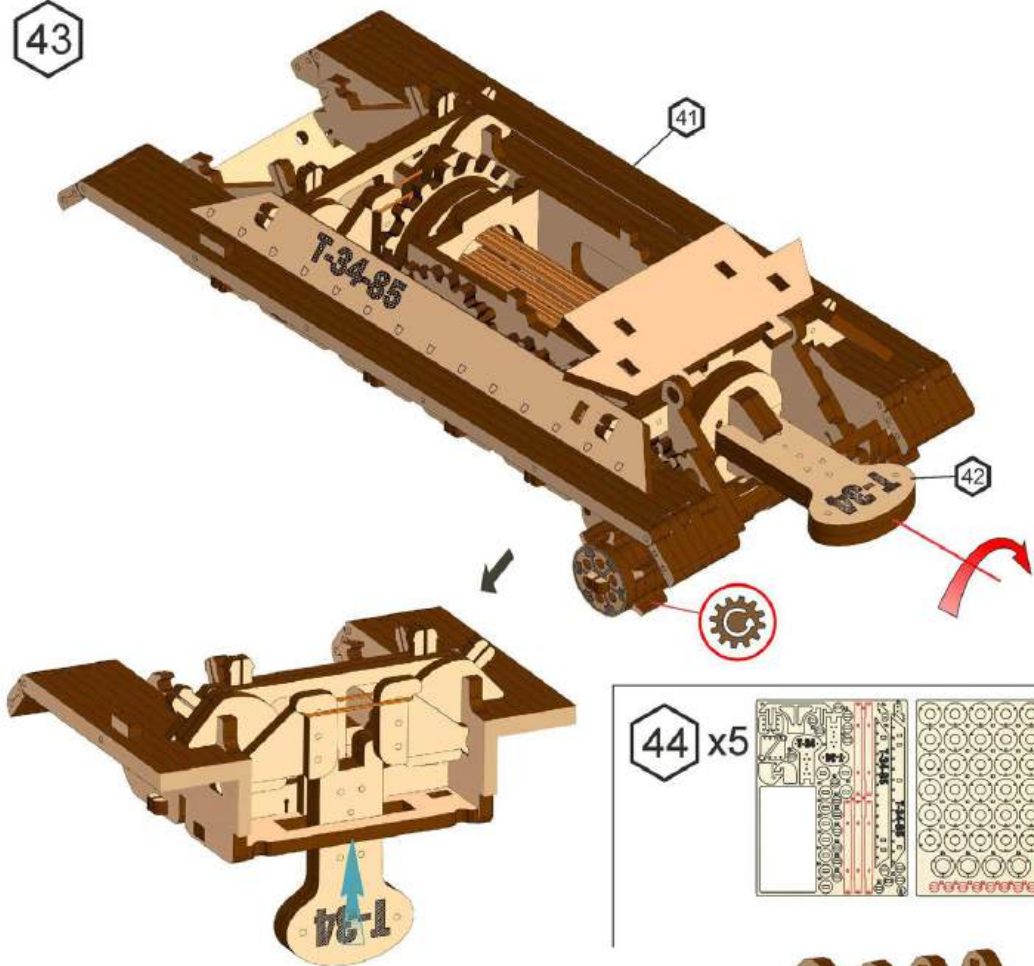

45 x10

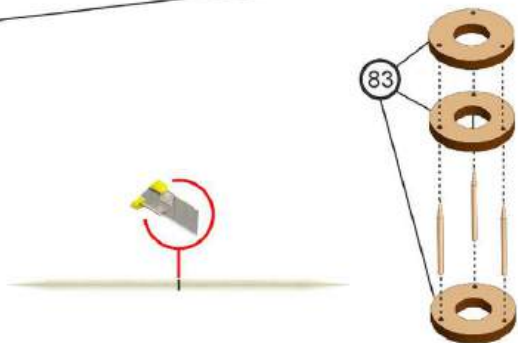

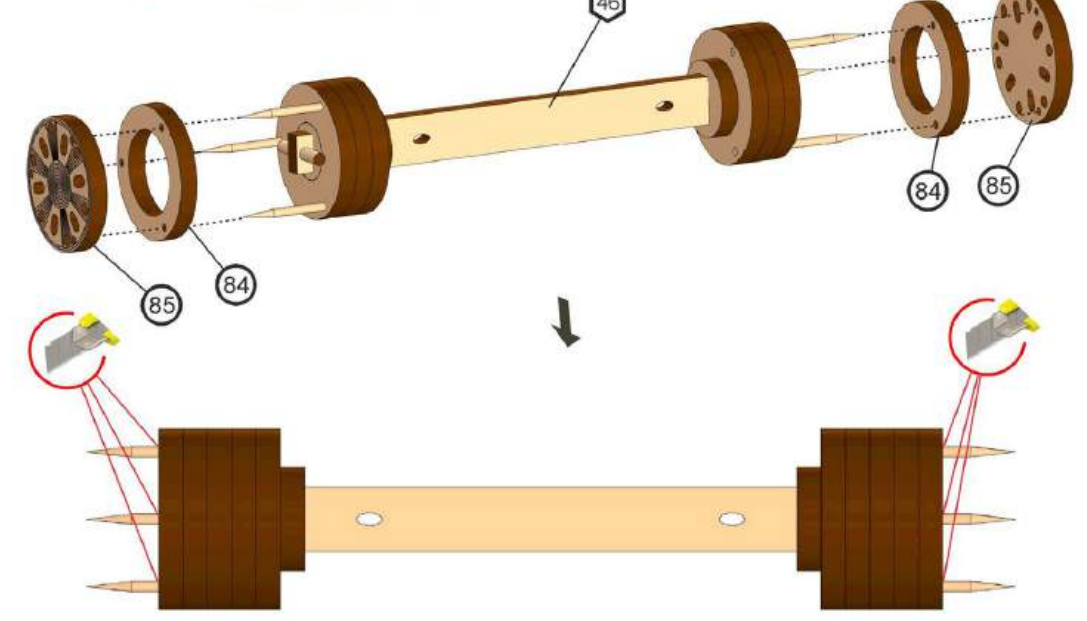
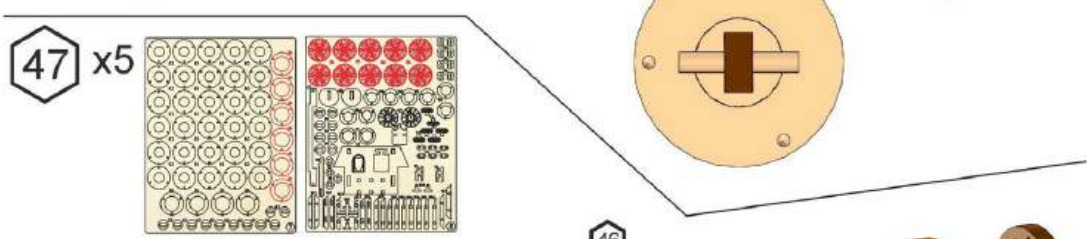
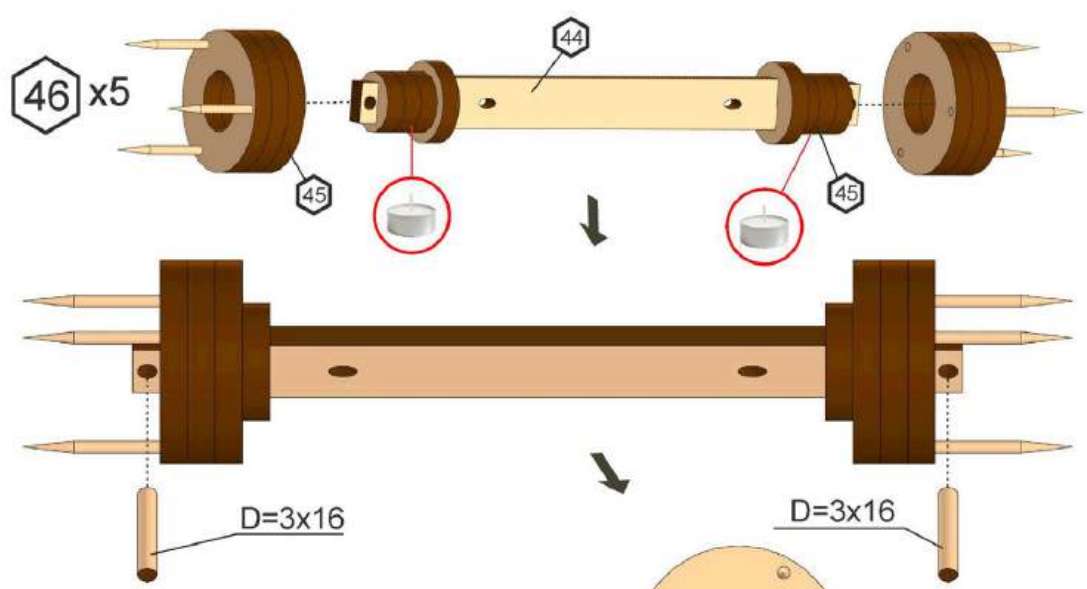

D=3x15

48

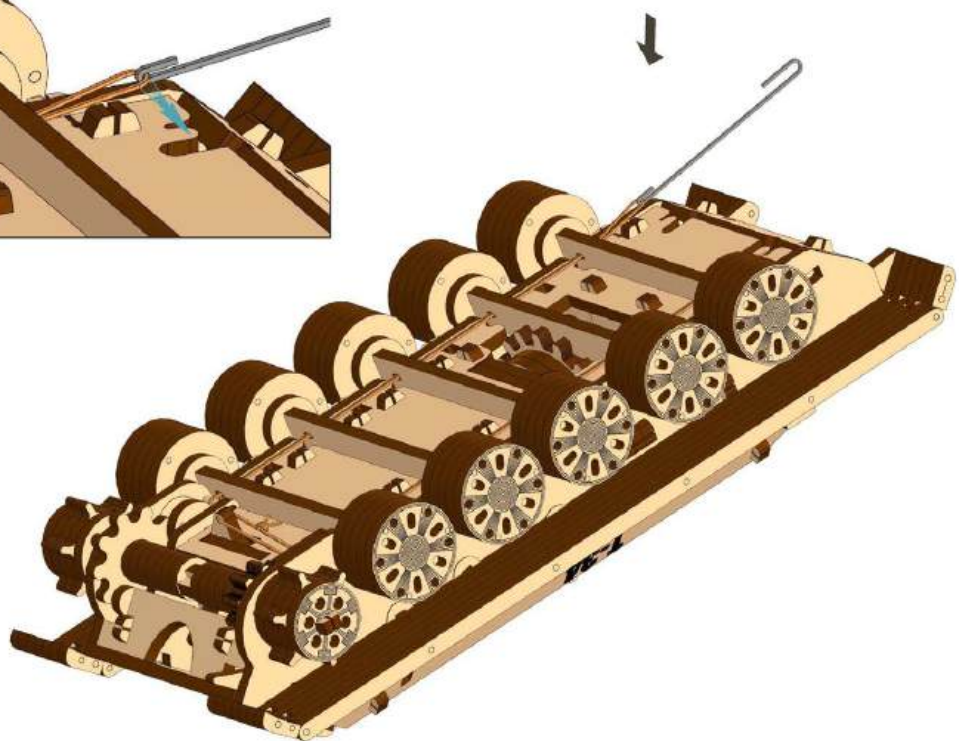
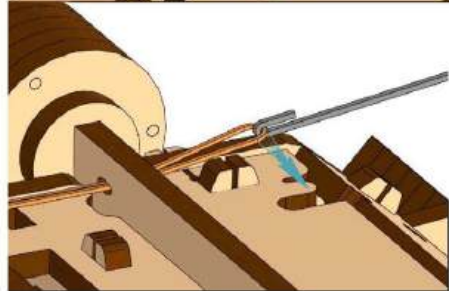
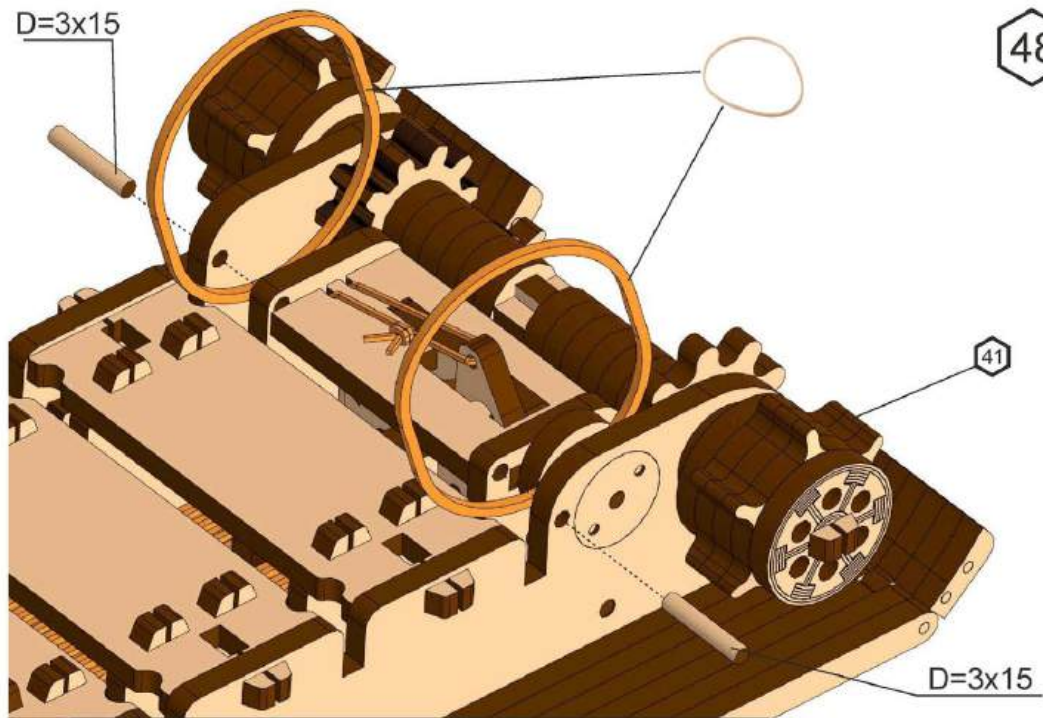



50

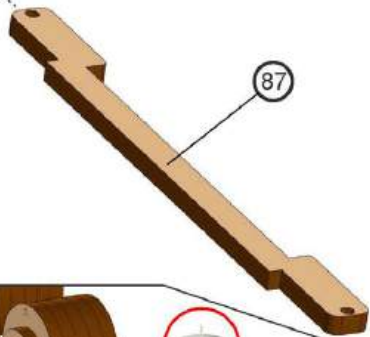
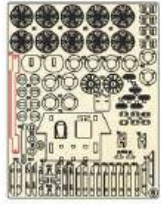
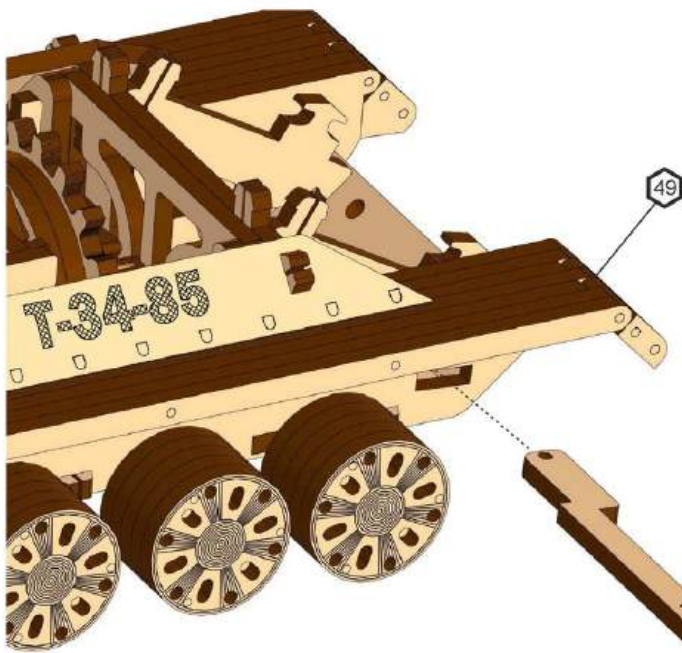

52 x2

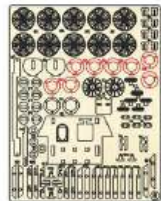
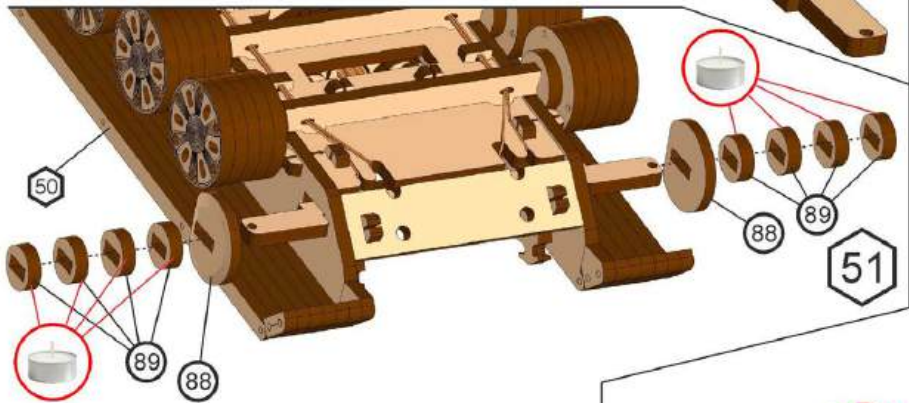
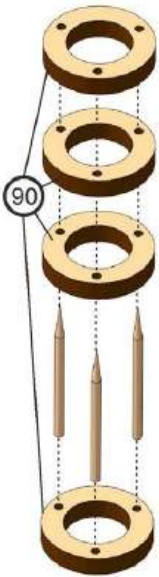

53

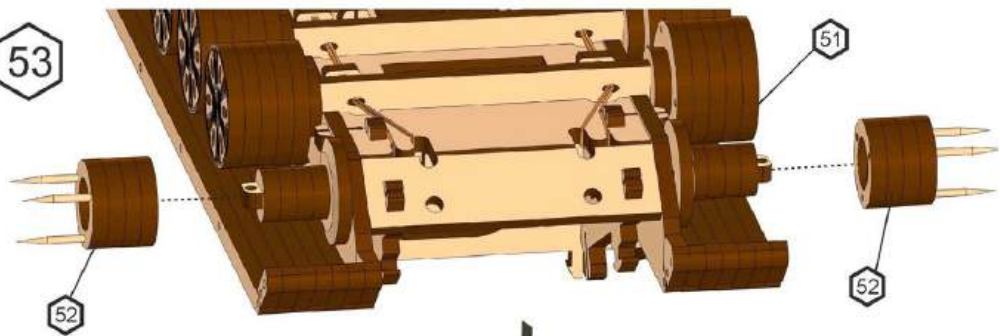

51

52

52



D=3x13

D=3x13

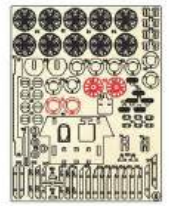
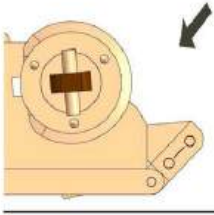
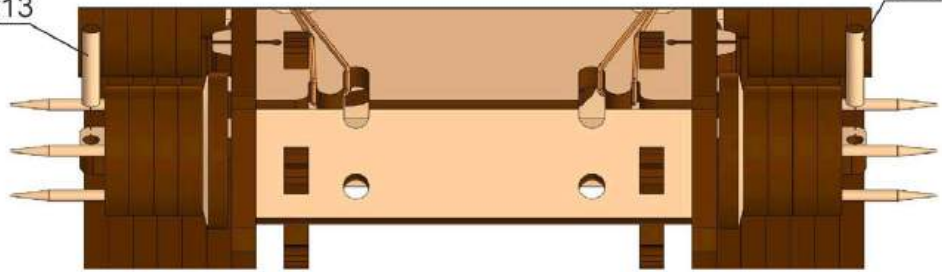

54

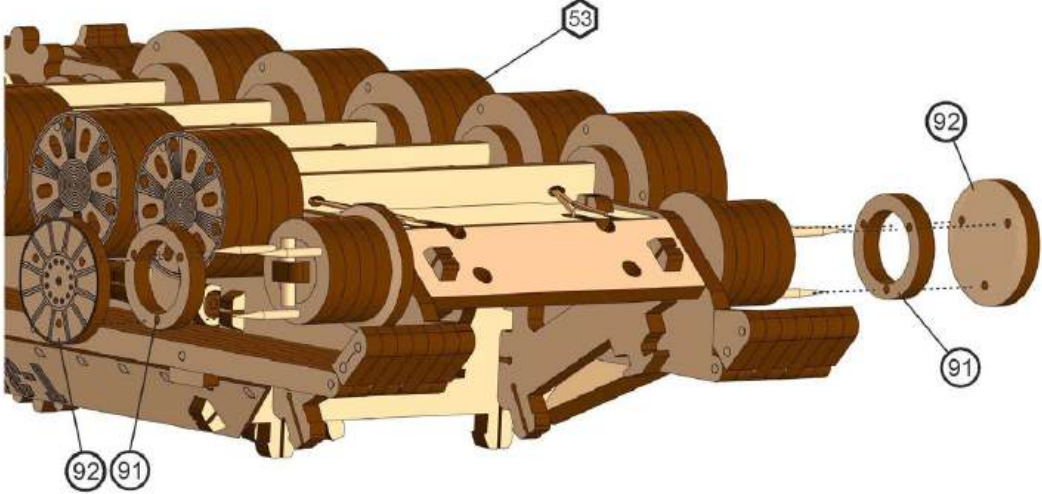

53

92

91

92

91

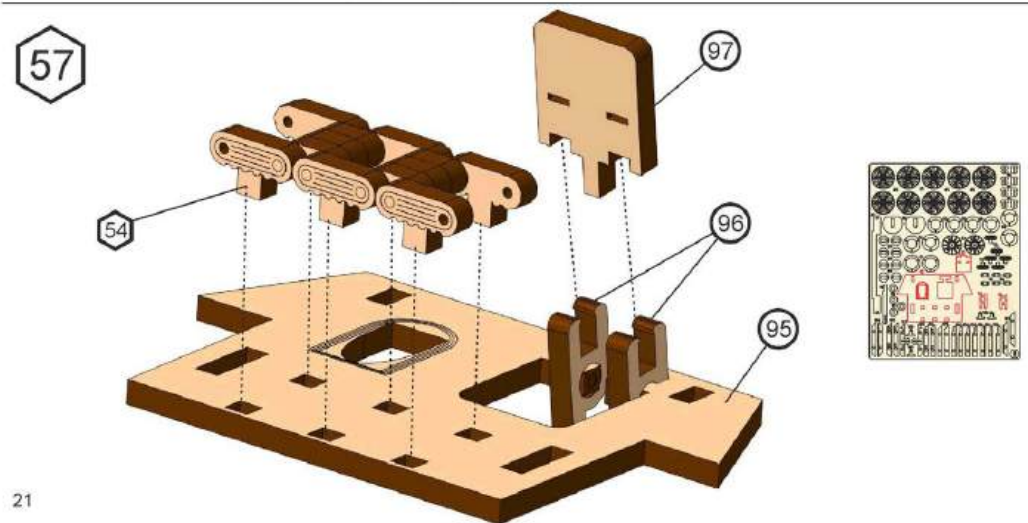
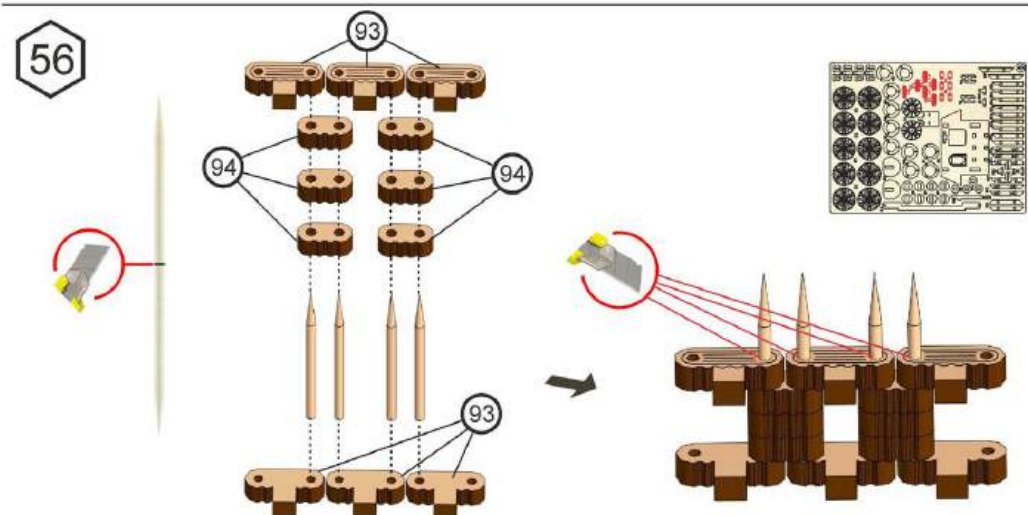
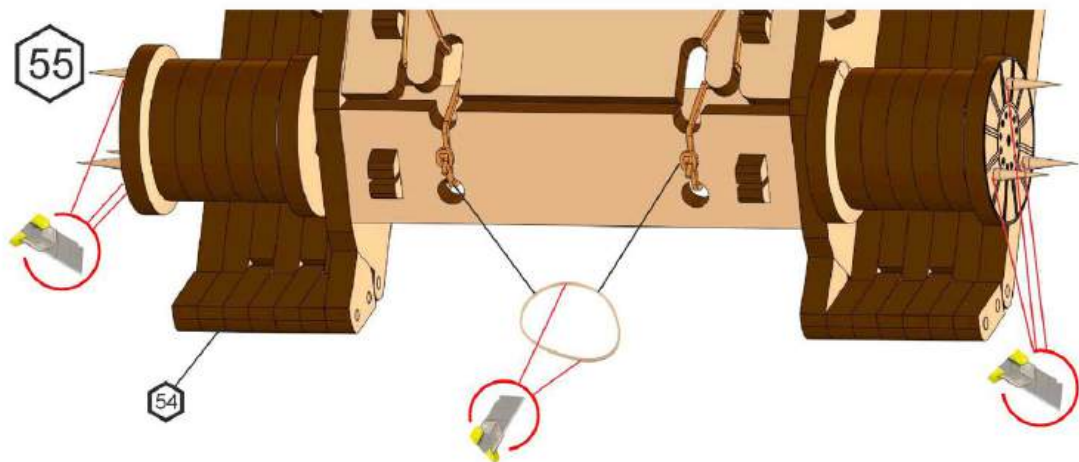

58

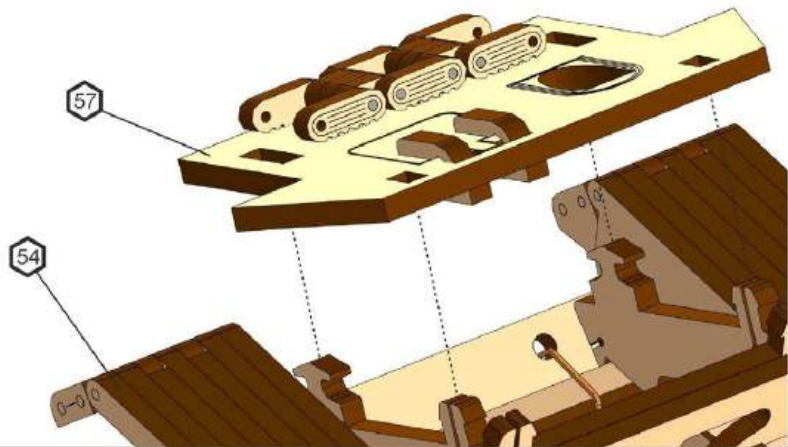

59

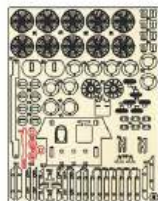
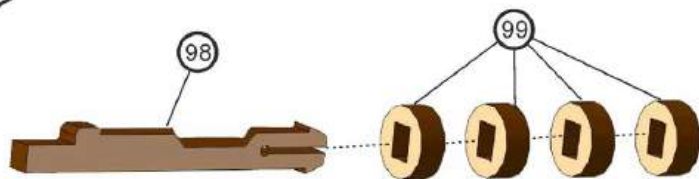

60

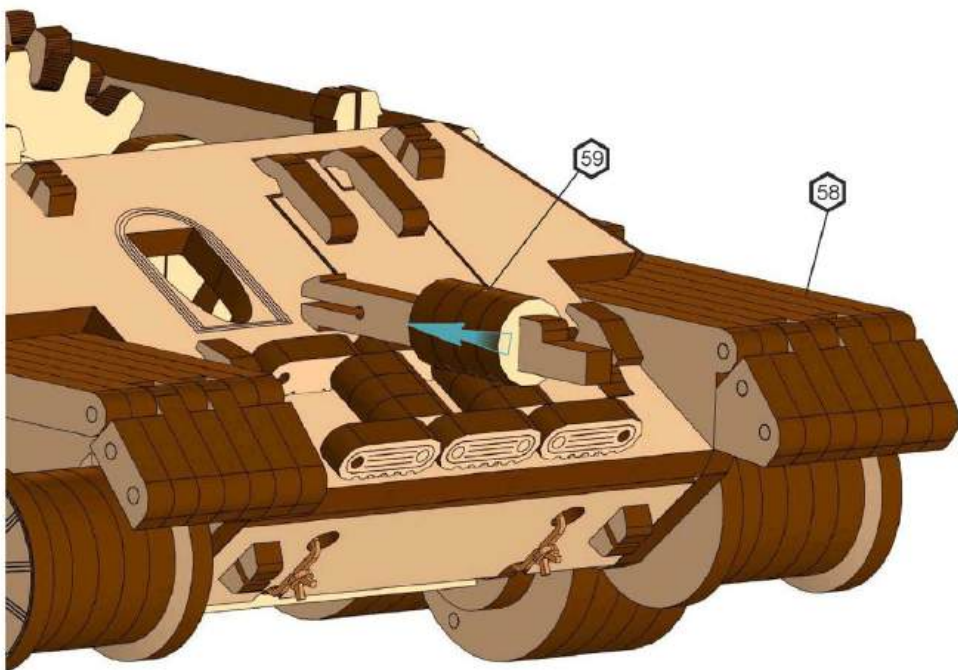

61 x2

62

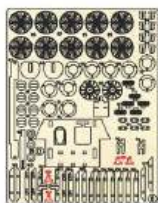
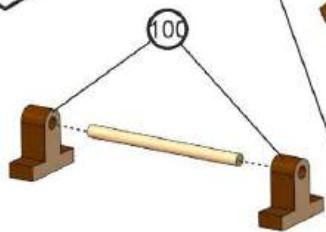

D=3x71

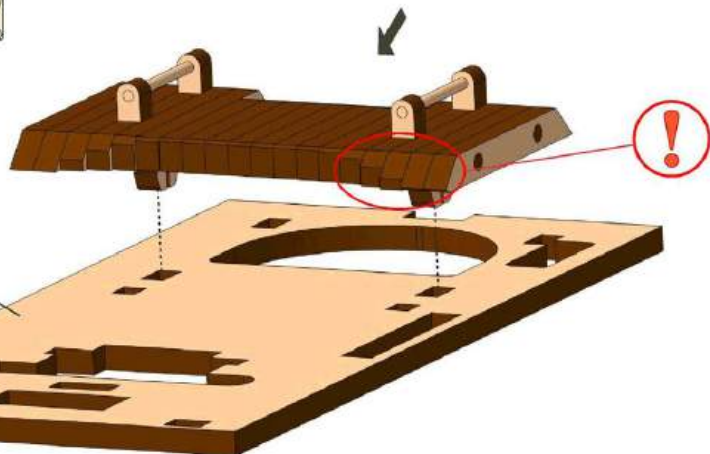
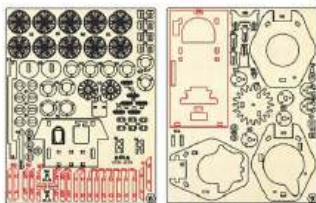
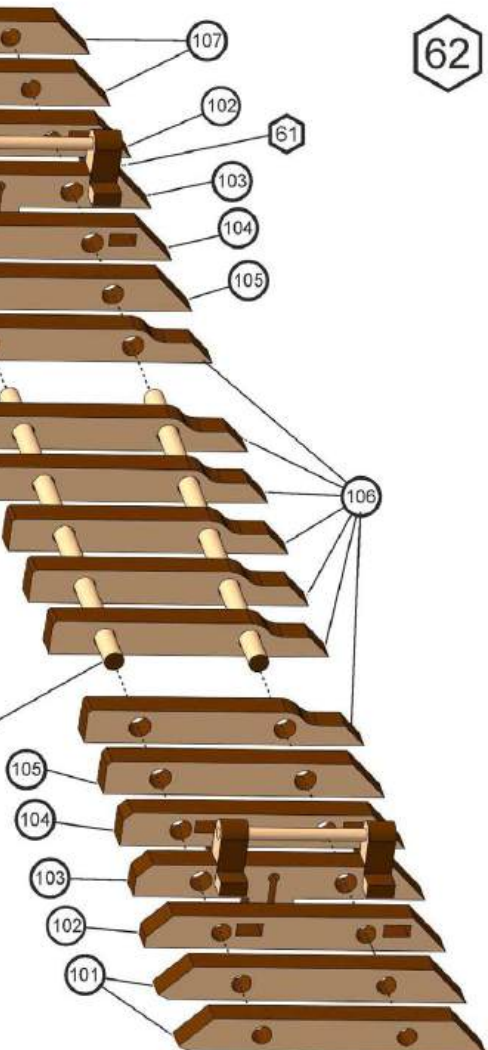

63

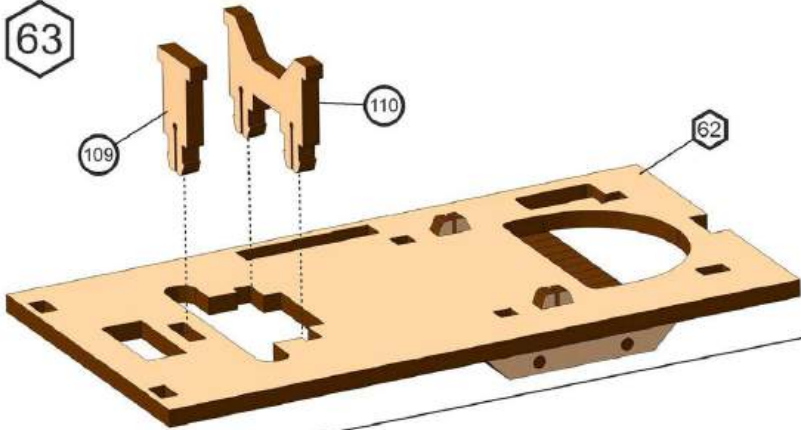

64

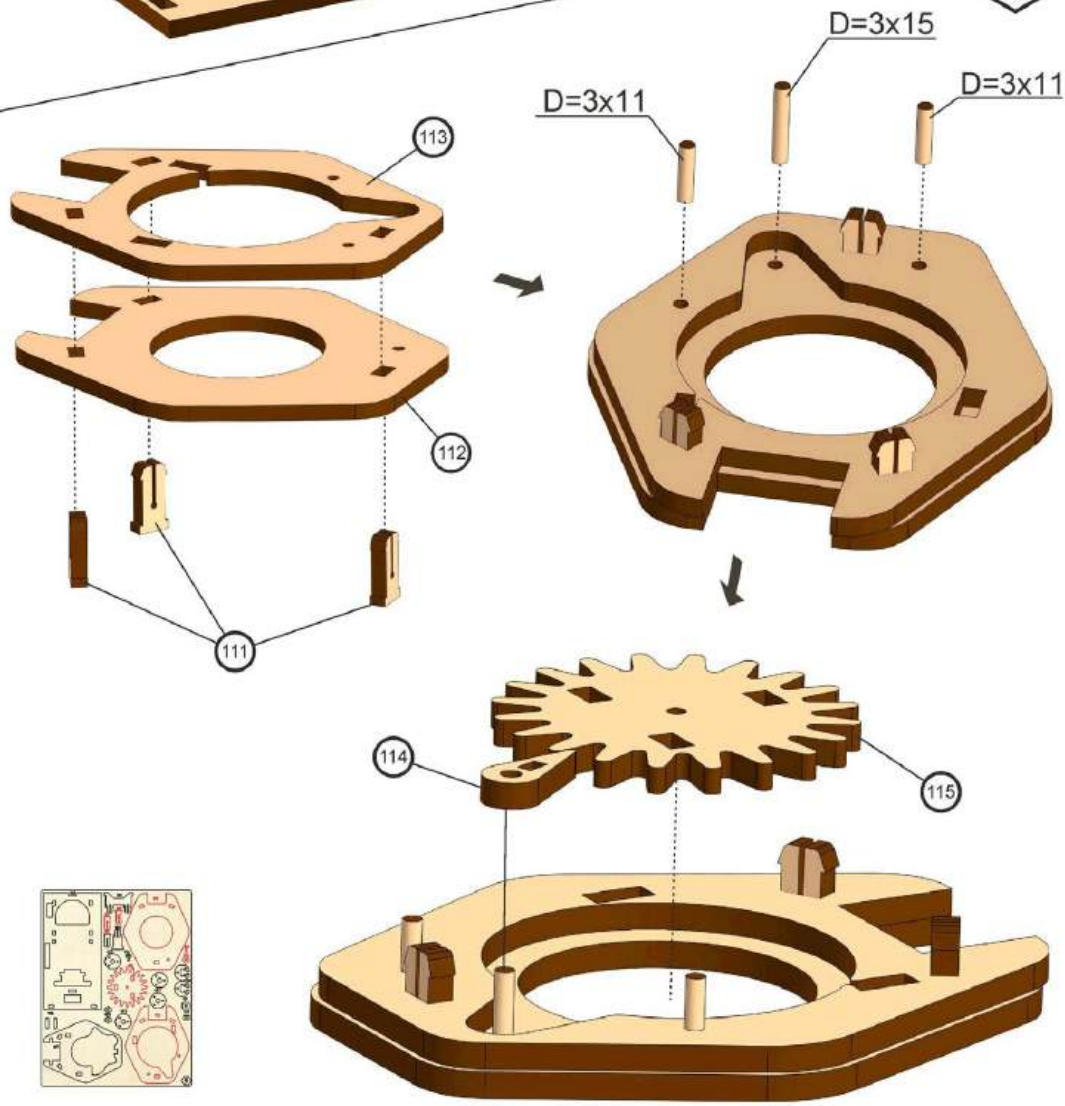

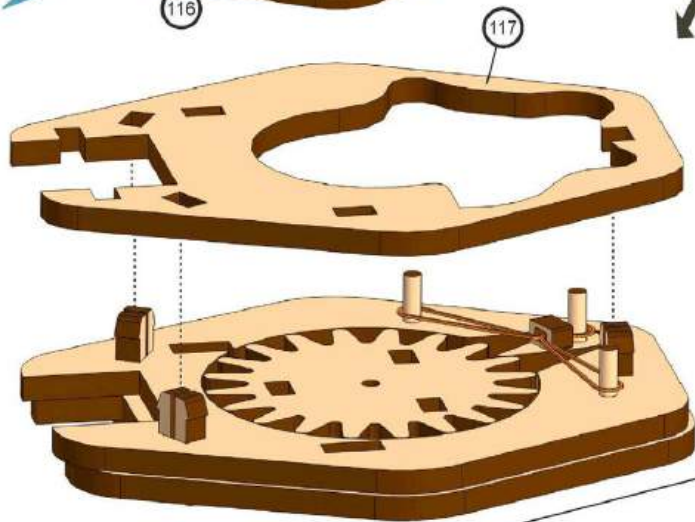
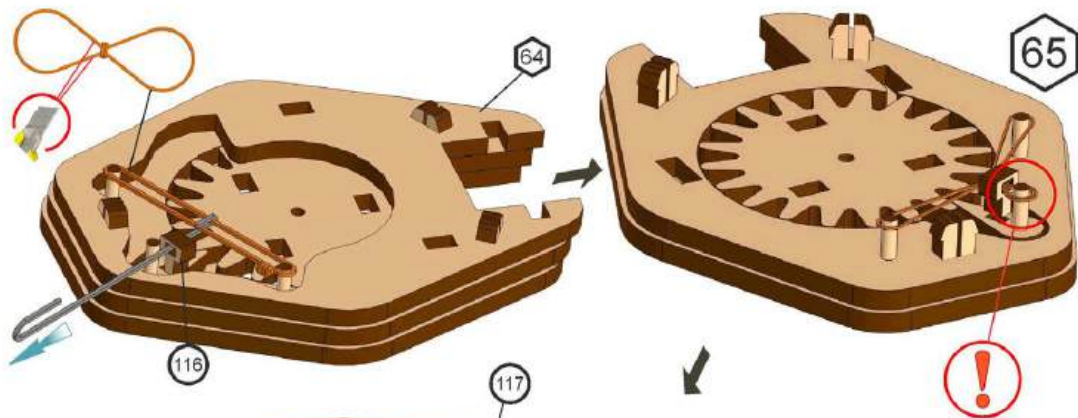

66

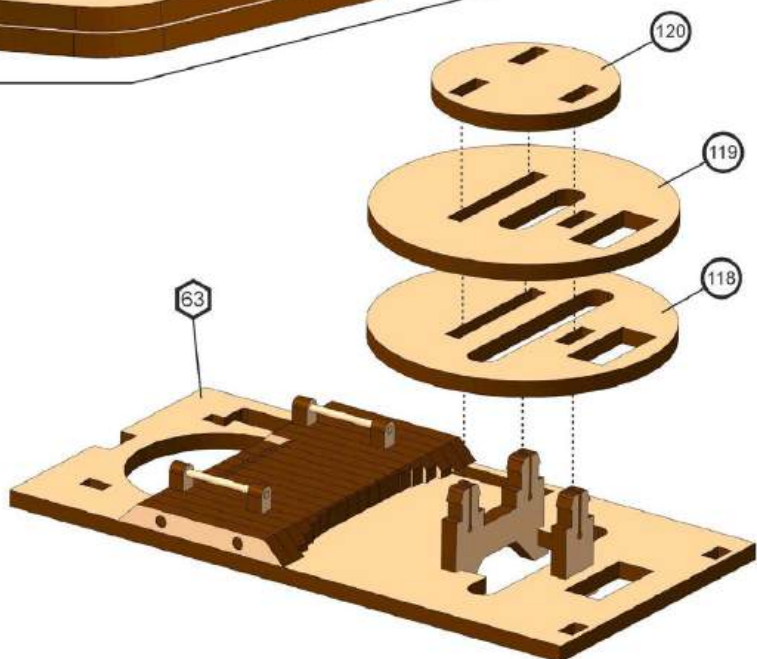
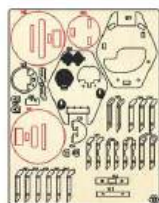

67

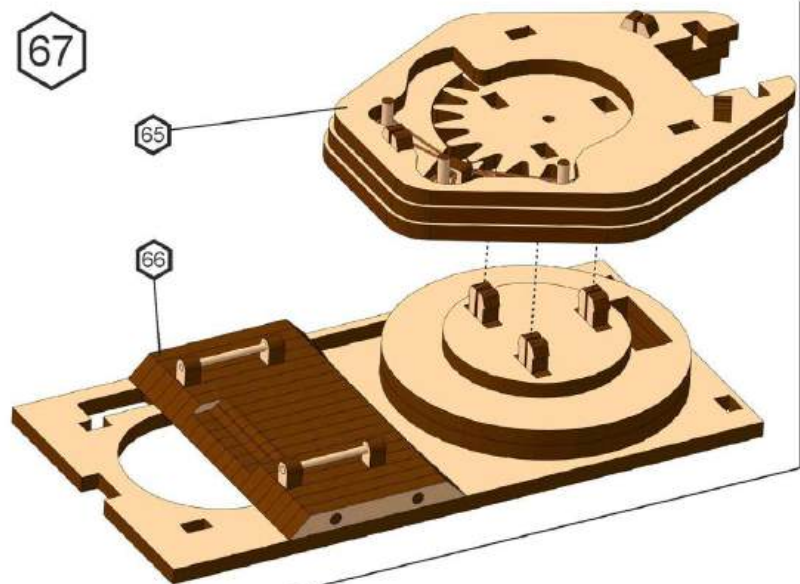

68

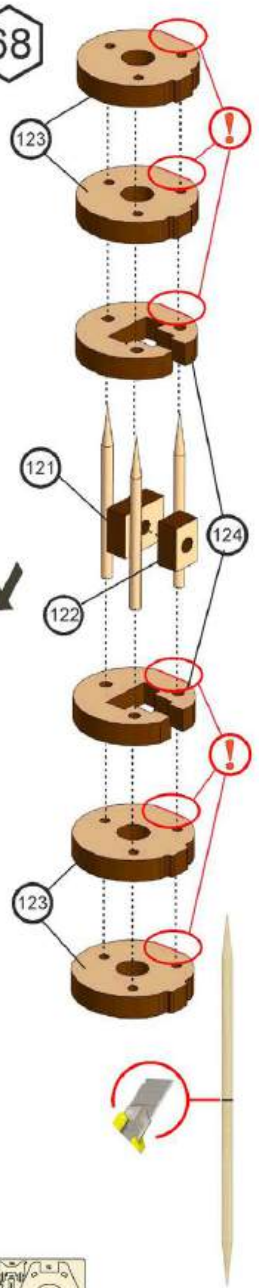

D=3x130

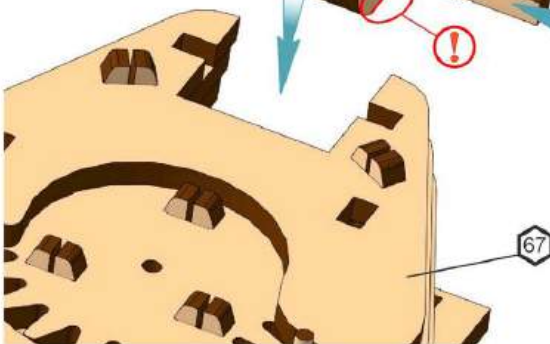
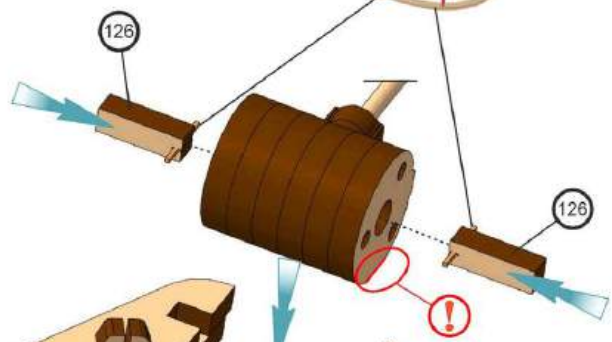
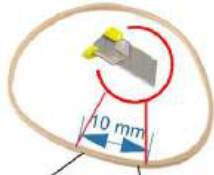
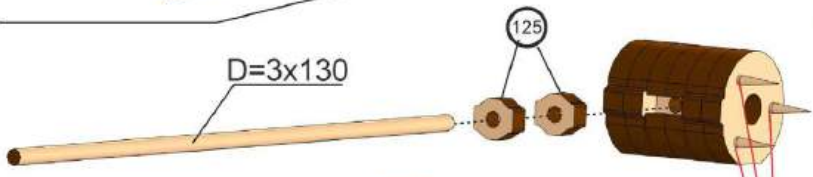

69

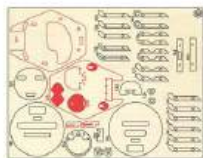
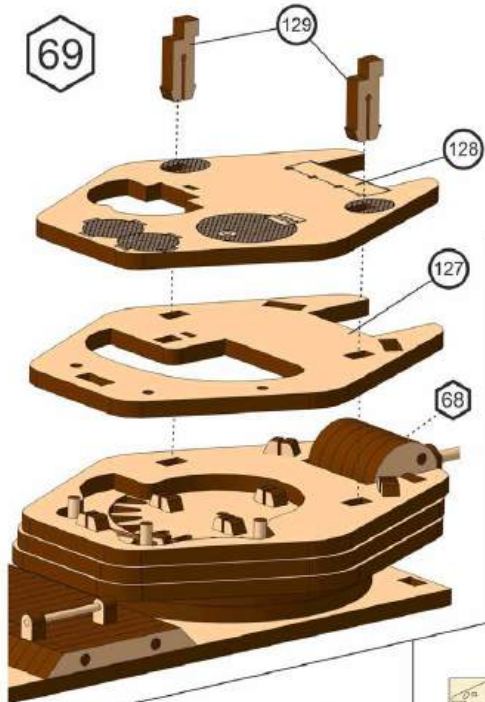

70

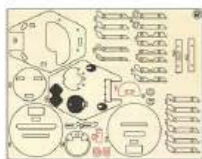
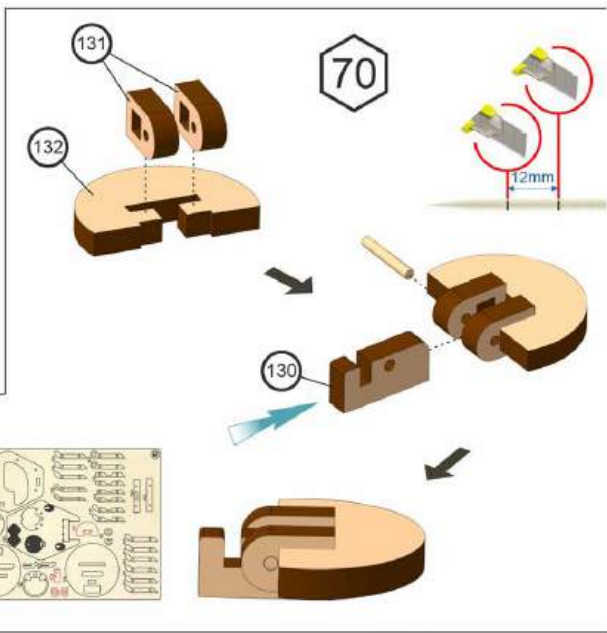

71

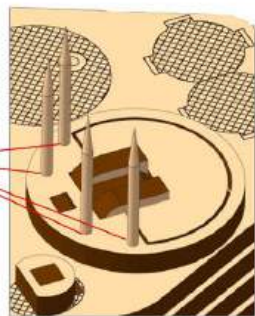
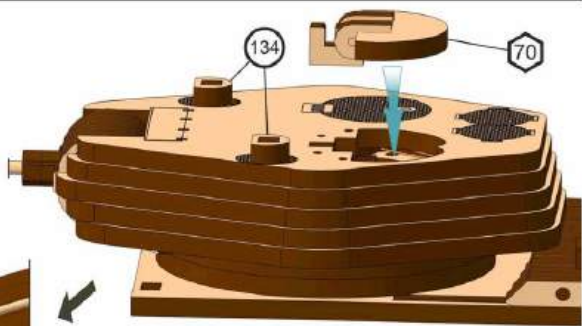
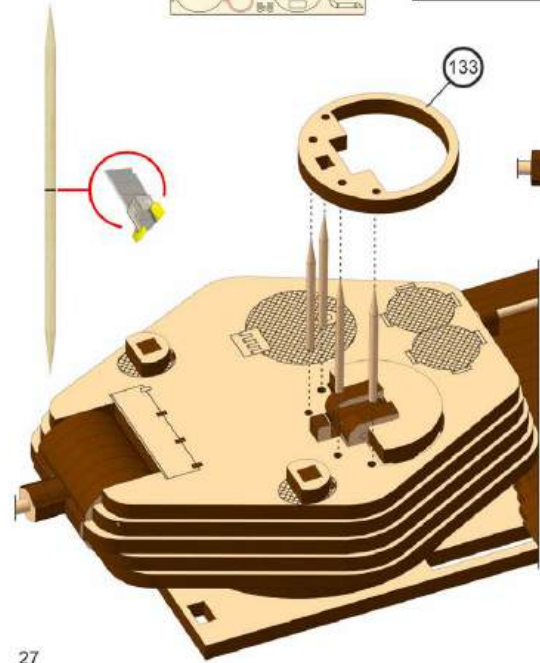

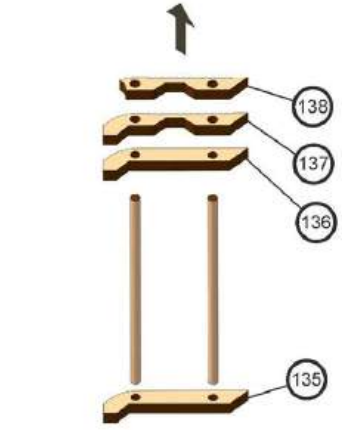
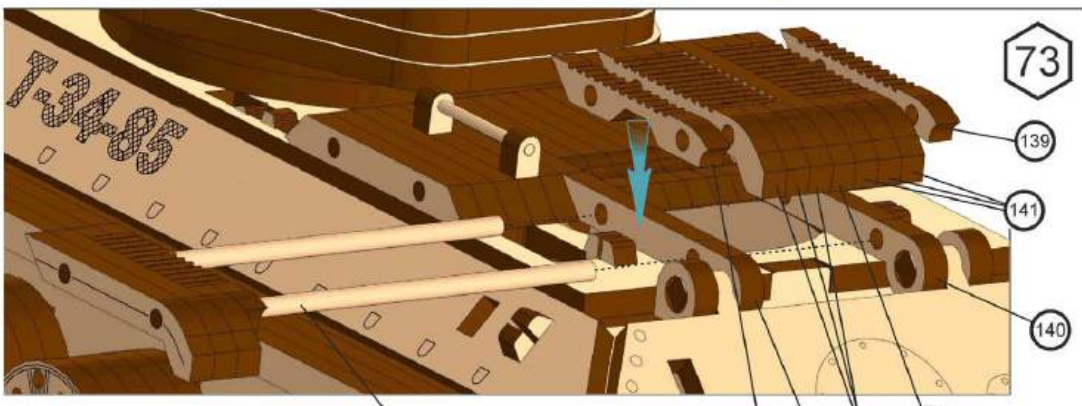
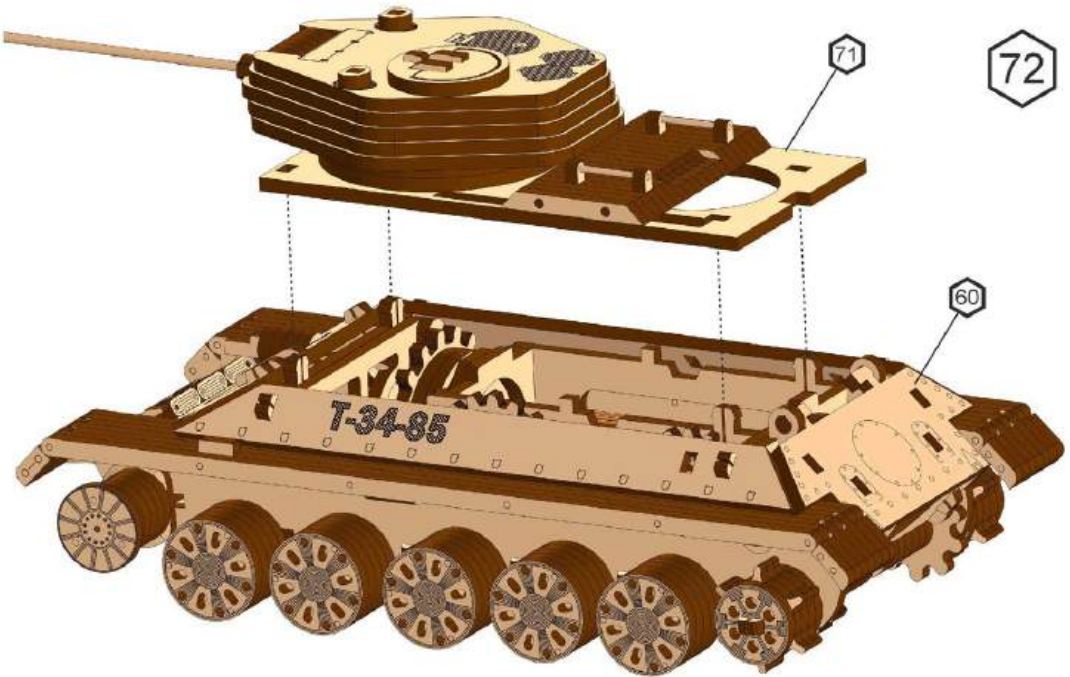

D=3x71



74

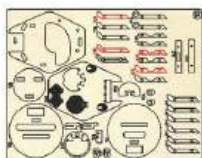
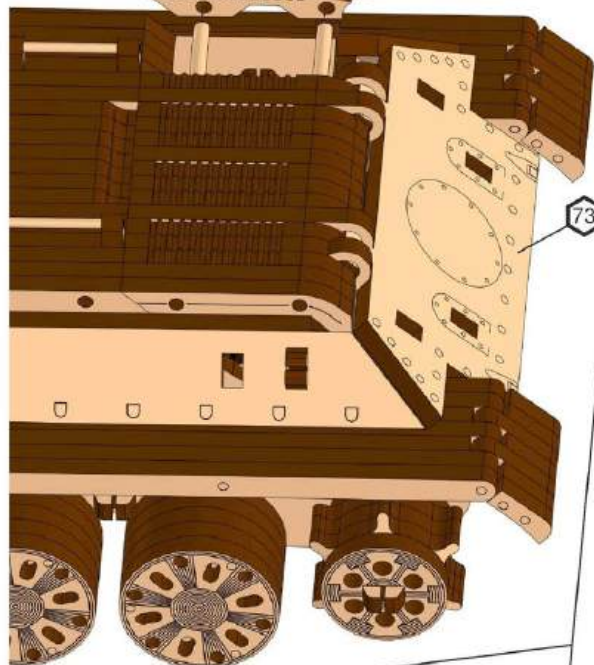
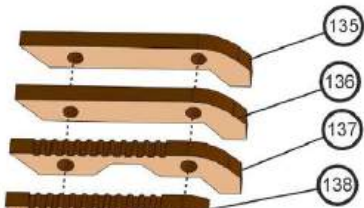

75

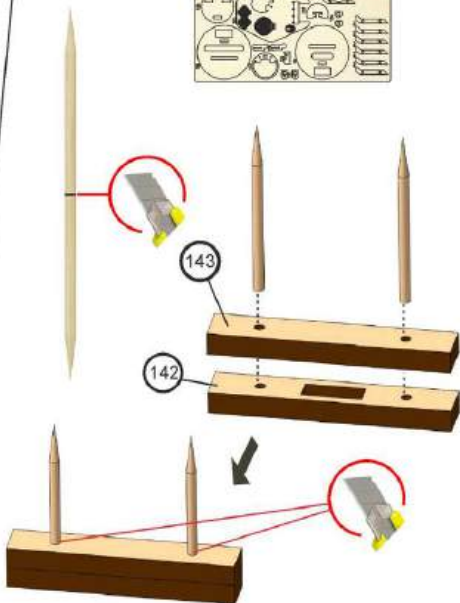
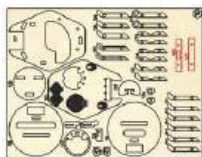

76

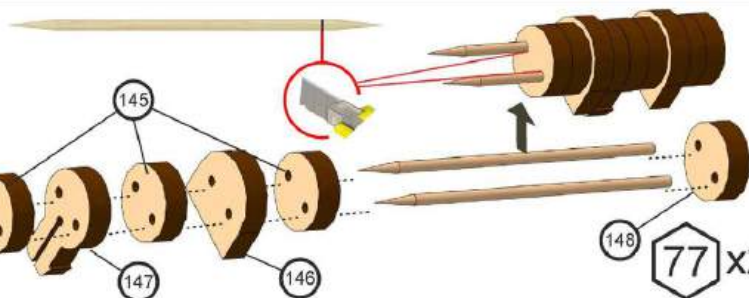
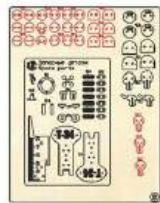
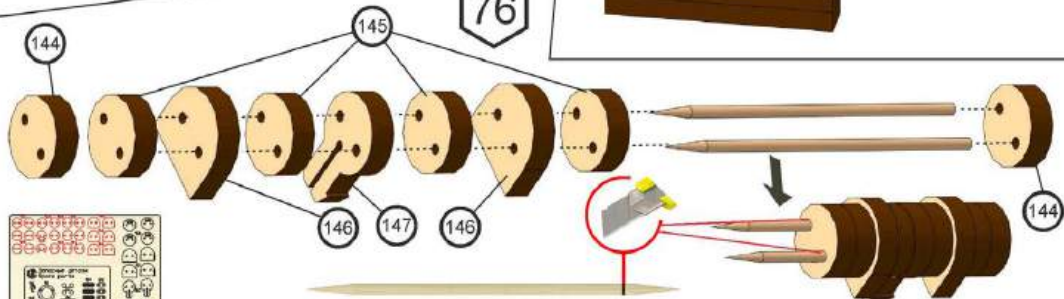

77 x2

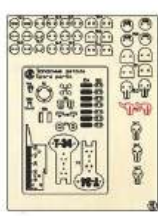
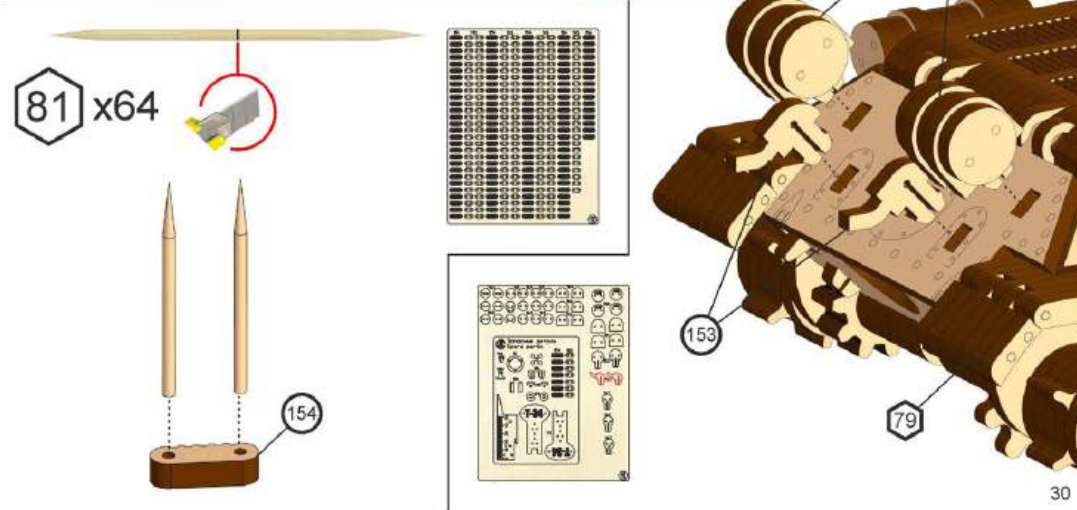
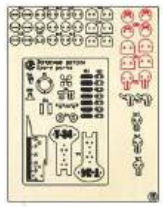
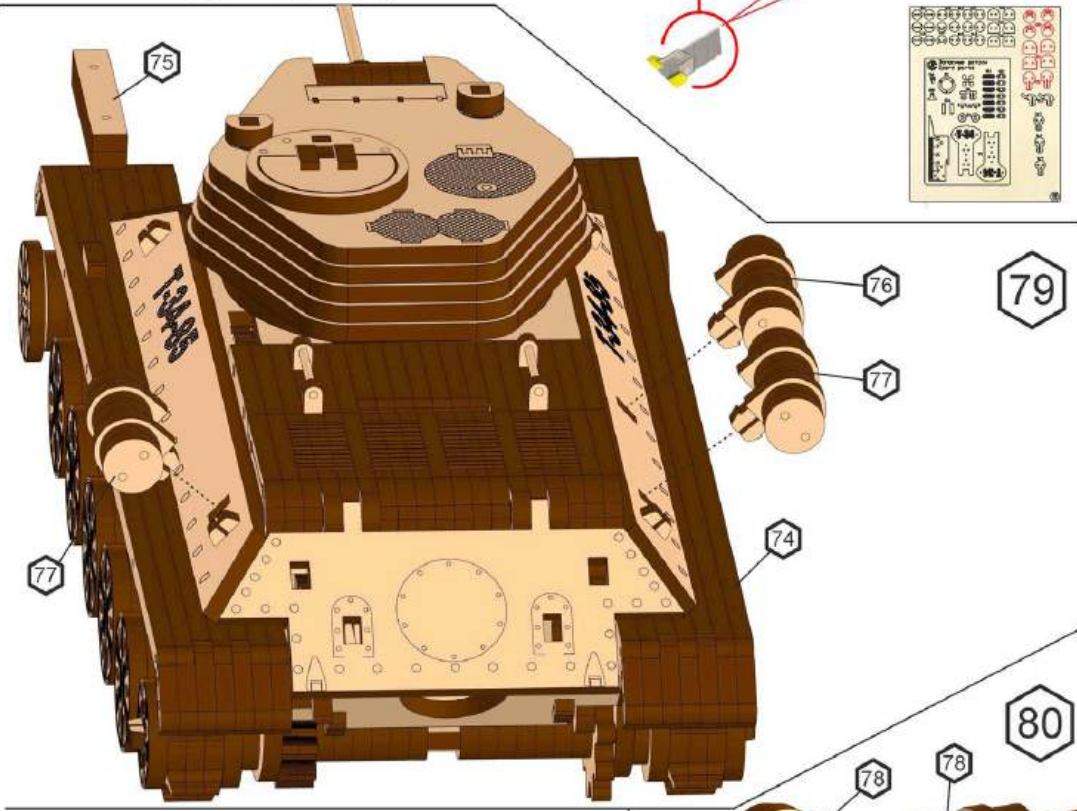
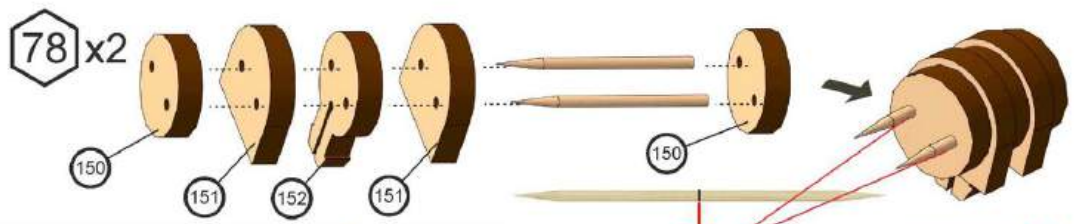

82 x2

155 x96

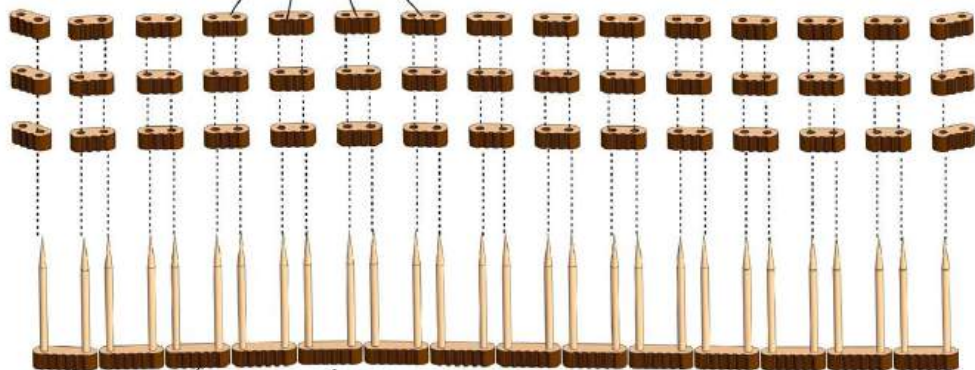

81 x32



1	2	3	4	5	6	7	8	9	10	11	12	13	14	15	16	17	18	19	20	21	22	23	24	25	26	27	28	29	30	31	32	33	34	35	36	37	38	39	40	41	42	43	44	45	46	47	48	49	50	51	52	53	54	55	56	57	58	59	60	61	62	63	64	65	66	67	68	69	70	71	72	73	74	75	76	77	78	79	80	81	82	83	84	85	86	87	88	89	90	91	92	93	94	95	96	97	98	99	100	101	102	103	104	105	106	107	108	109	110	111	112	113	114	115	116	117	118	119	120	121	122	123	124	125	126	127	128	129	130	131	132	133	134	135	136	137	138	139	140	141	142	143	144	145	146	147	148	149	150	151	152	153	154	155
---	---	---	---	---	---	---	---	---	----	----	----	----	----	----	----	----	----	----	----	----	----	----	----	----	----	----	----	----	----	----	----	----	----	----	----	----	----	----	----	----	----	----	----	----	----	----	----	----	----	----	----	----	----	----	----	----	----	----	----	----	----	----	----	----	----	----	----	----	----	----	----	----	----	----	----	----	----	----	----	----	----	----	----	----	----	----	----	----	----	----	----	----	----	----	----	----	----	----	-----	-----	-----	-----	-----	-----	-----	-----	-----	-----	-----	-----	-----	-----	-----	-----	-----	-----	-----	-----	-----	-----	-----	-----	-----	-----	-----	-----	-----	-----	-----	-----	-----	-----	-----	-----	-----	-----	-----	-----	-----	-----	-----	-----	-----	-----	-----	-----	-----	-----	-----	-----	-----	-----	-----	-----

