

Assembly Instruction

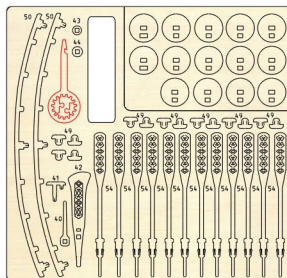

DRAKKAR

- EN** The ledge is for the squeezing the small details out of the board
PL Występ w linijce przeznaczony jest do wyciskania małych detali z arkusza sklejk
FR La proéminence est conçue pour aider à presser et enlever les petits détails de la feuille
ES La repisa es para apretar los pequeños detalles fuera del tablero
DE Der Vorsprung dient dazu, kleine Teile aus den Platten zu drücken
RU Выступ предназначен для выдавливания из листа мелких деталей
IT Le proiezioni riportate sui fogli di istruzione sono utili anche nella fase di smontaggio per estrarre i pezzi
CZ Použijte k vytlačení malých částí z desky
CN 輔助測量尺可幫助取出或緊接細小零件時使用



- EN** Cut it with a razor blade
PL Odetnij nożem do kopert
FR Couper avec un cutter
ES Cortar con un bisturí
DE Mit Rasierklinge durchschneiden
RU Обрезать канцелярским ножом
IT Tagliare con un coltello da cancelleria
CZ Vyřizněte fezákem
CN 用刀片切斷



- EN** Remove the burrs with sandpaper
PL Usunąć zadziory papierem ściernym
FR Retirer les bavures avec du papier à polir
ES Quitar las rebabas con el papel esmeril
DE Grate mit Schleifpapier entfernen
RU Удалить заусенцы наждачной бумагой
IT Sbavare con carta vetrata
CZ Vyhladte smirkových papírem
CN 用砂紙去除毛刺



- EN** Details should rotate freely
PL Swobodne obracanie
FR Libre rotation
ES Rotación libre
DE Auf freie Rotation achten
RU Свободное вращение
IT Rotazione libera
CZ Části by se měly volně otáčet
CN 流畅地旋轉



- EN** Wax it with a candle
PL Posmaruj za pomocą świecy parafinowej
FR Graisser avec une bougie de paraffine
ES Engrasar con ayuda de una vela de parafina
DE Mit einer Kerze wachsen
RU Смазать парафиновой свечой
IT Lubrificare con candela di paraffina
CZ Navoskuje svíčkou
CN 用于蜡烛上蜡润滑



- EN** Pay attention
PL Uwaga
FR Prête attention
ES Prestar atención
DE Achtung
RU Уделить внимание
IT Prestare attenzione
CZ Pozor
CN 请注意

EN The manufacturer reserves the right to make changes in the design of the product, not worsening its technical characteristics. Information about the changes made may not be present in this manual.

PL Producent zastrzega sobie prawo do zmiany konstrukcji wyrobu bez pogorszenia jego właściwości technicznych. Niniejsza instrukcja może nie zawierać informacji o zmianach.

FR Le producteur se réserve le droit d'apporter des modifications dans la construction du produit à condition si elles ne portent atteinte à ses caractéristiques techniques. Les renseignements sur les modifications apportées peuvent ne pas être dans la présente notice.

ES El fabricante se reserva el derecho de introducir modificaciones en la construcción del producto, que no empeoran sus características técnicas. Datos sobre modificaciones introducidas pueden no aparecer en esta instrucción.

DE Der Hersteller behält sich das Recht auf Designänderungen, die die technischen Merkmale und Funktionen nicht negativ beeinflussen, vor.

RU Производитель оставляет за собой право вносить изменения в конструкцию изделия, не ухудшающие его технические характеристики. Сведения о внесенных изменениях могут отсутствовать в настоящей инструкции.

IT Il produttore si riserva il diritto di apportare modifiche al design del prodotto, non peggiorando le sue caratteristiche tecniche. Informazioni sulle modifiche apportate potrebbero non essere presenti in questo manuale.

CZ Výrobce si vyhrazuje právo na takové změny v designu produktu, které nebudou mít za následek zhoršení technických vlastností. Informace o změnách nemusí být v návodu uvedeny.

CN 制造商保留对产品的设计更改的权利，一切改良旨在增强产品的技术性能。改良处若未出现在手册中，敬请谅解

1

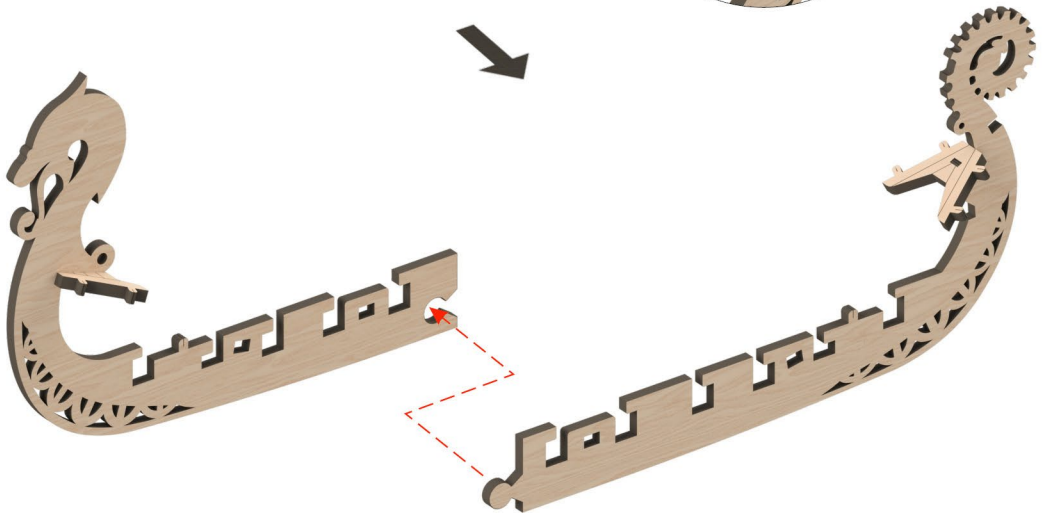
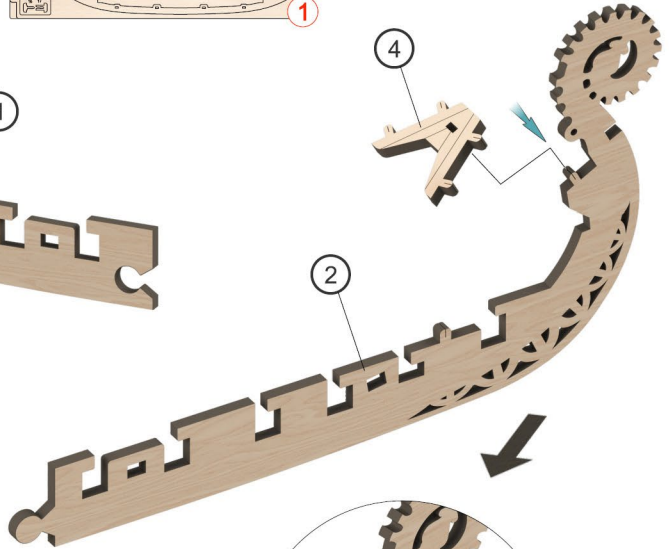
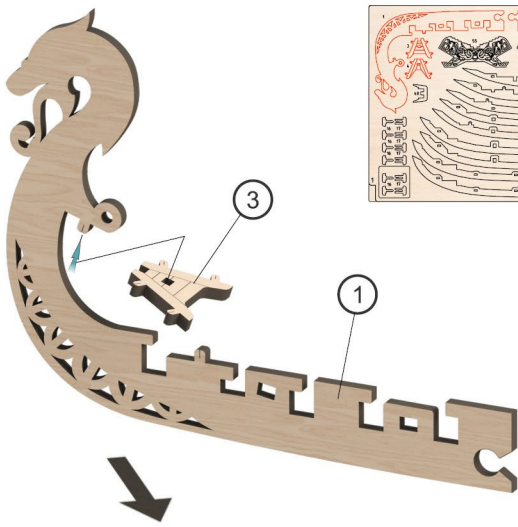
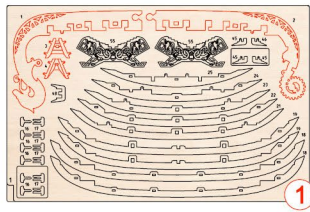

2

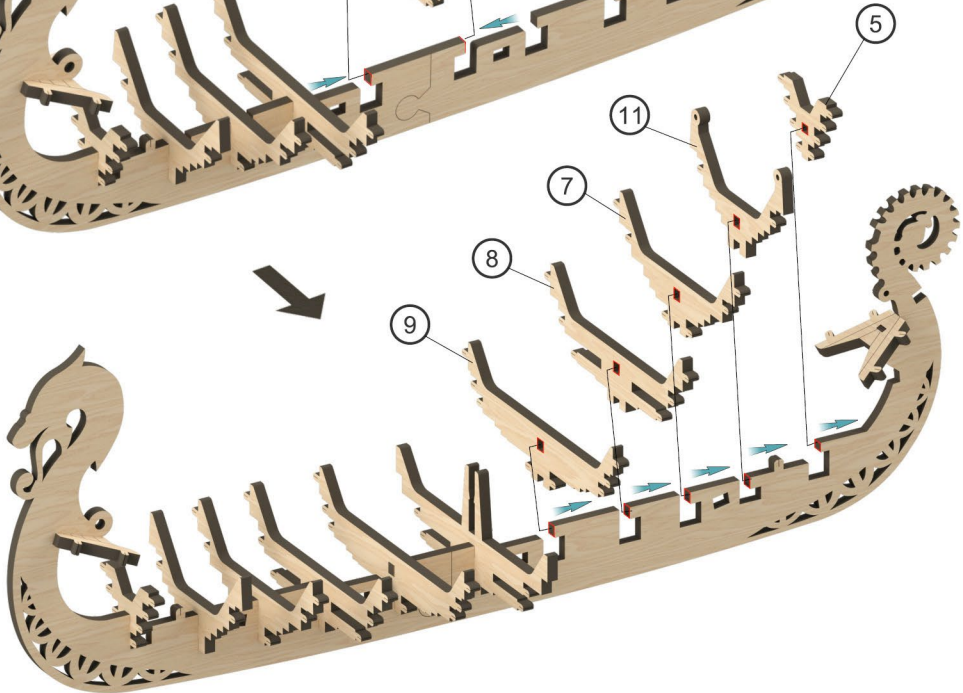
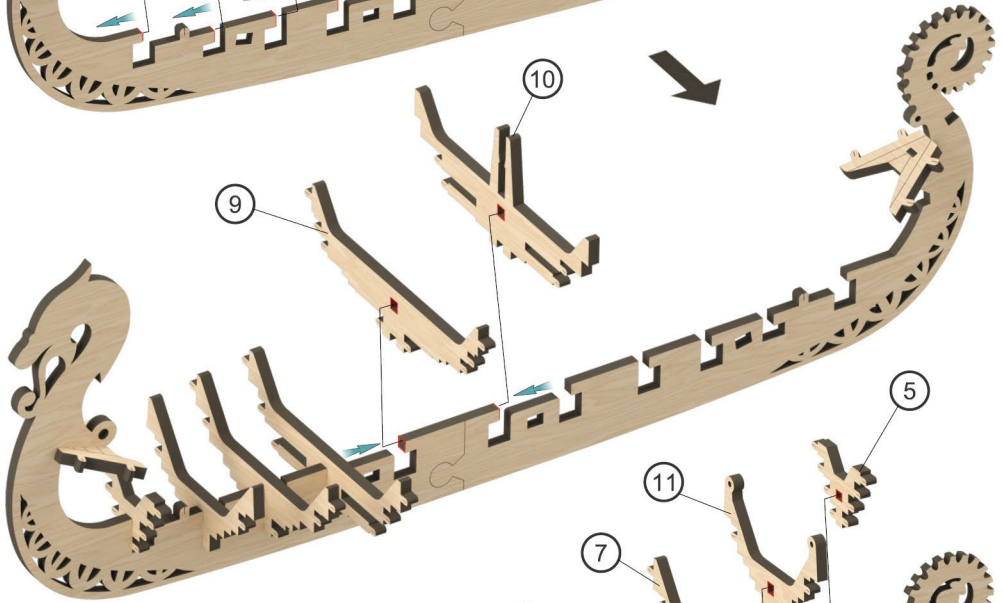
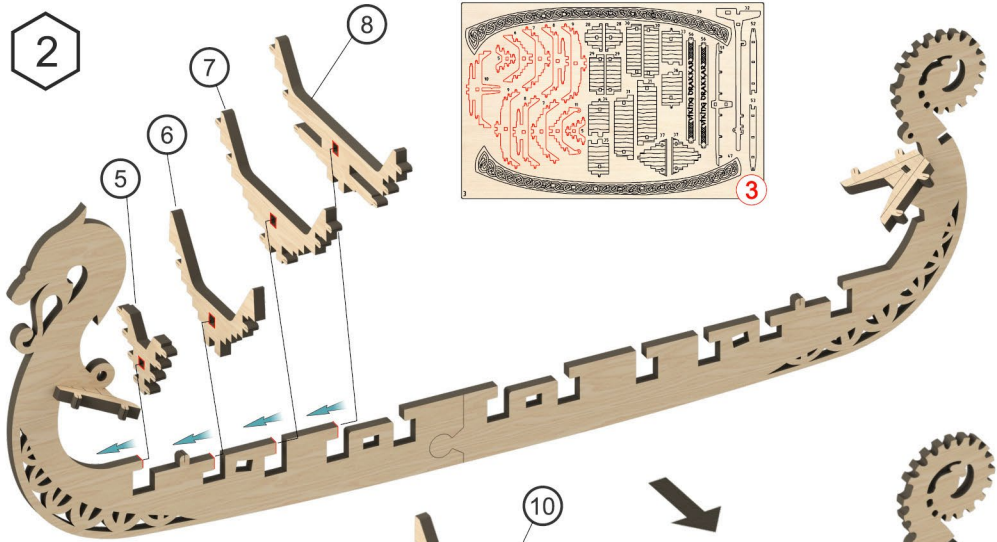

3

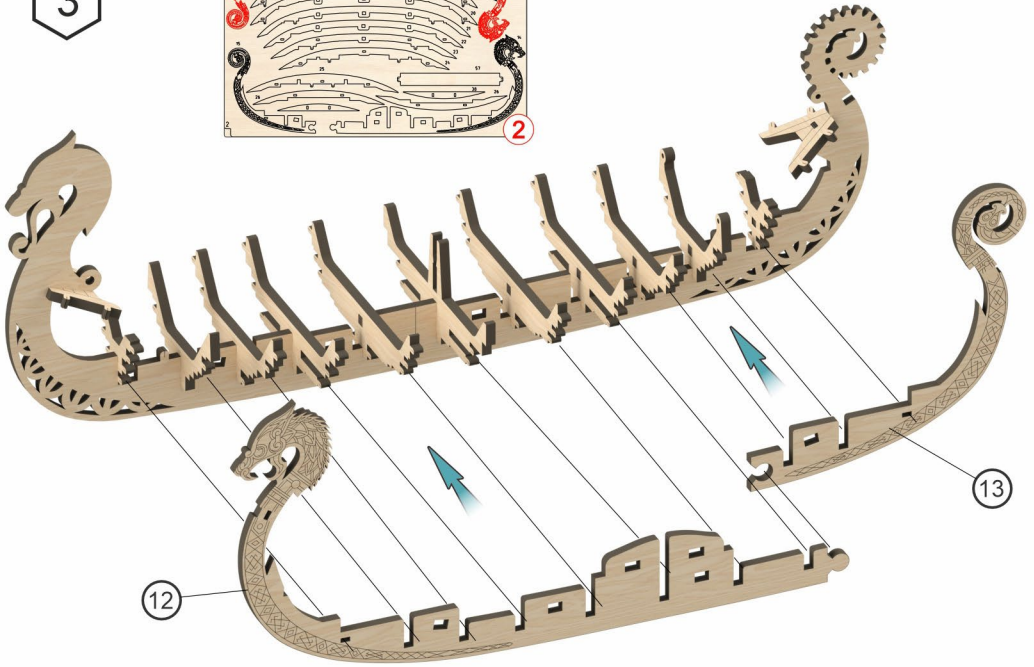
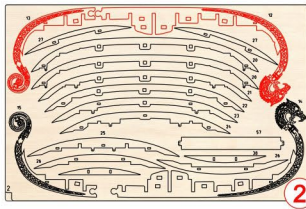

4

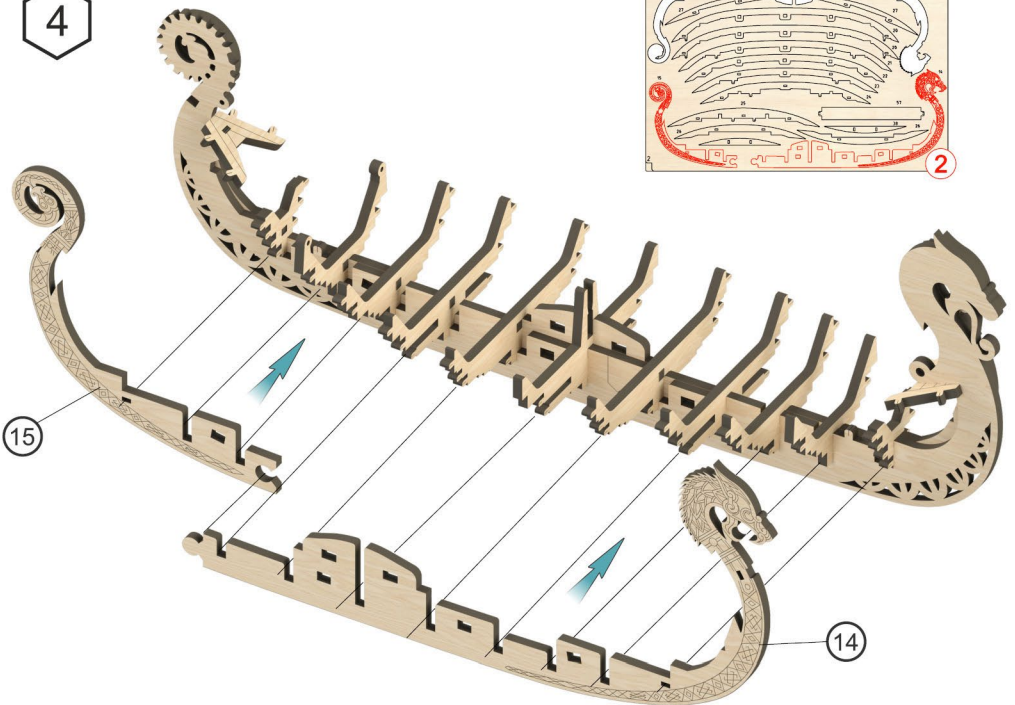
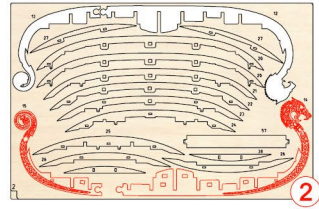

5

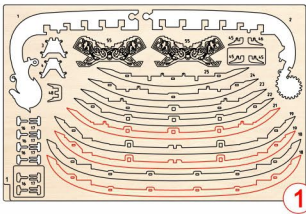
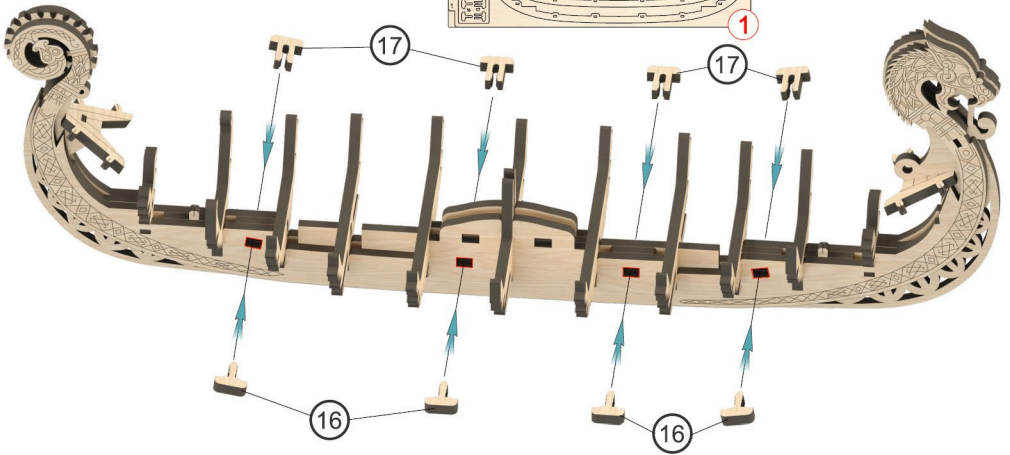
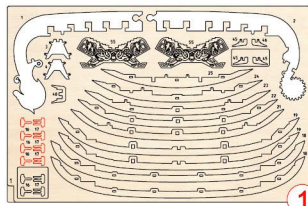

6

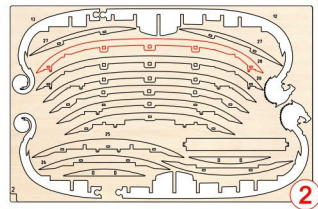
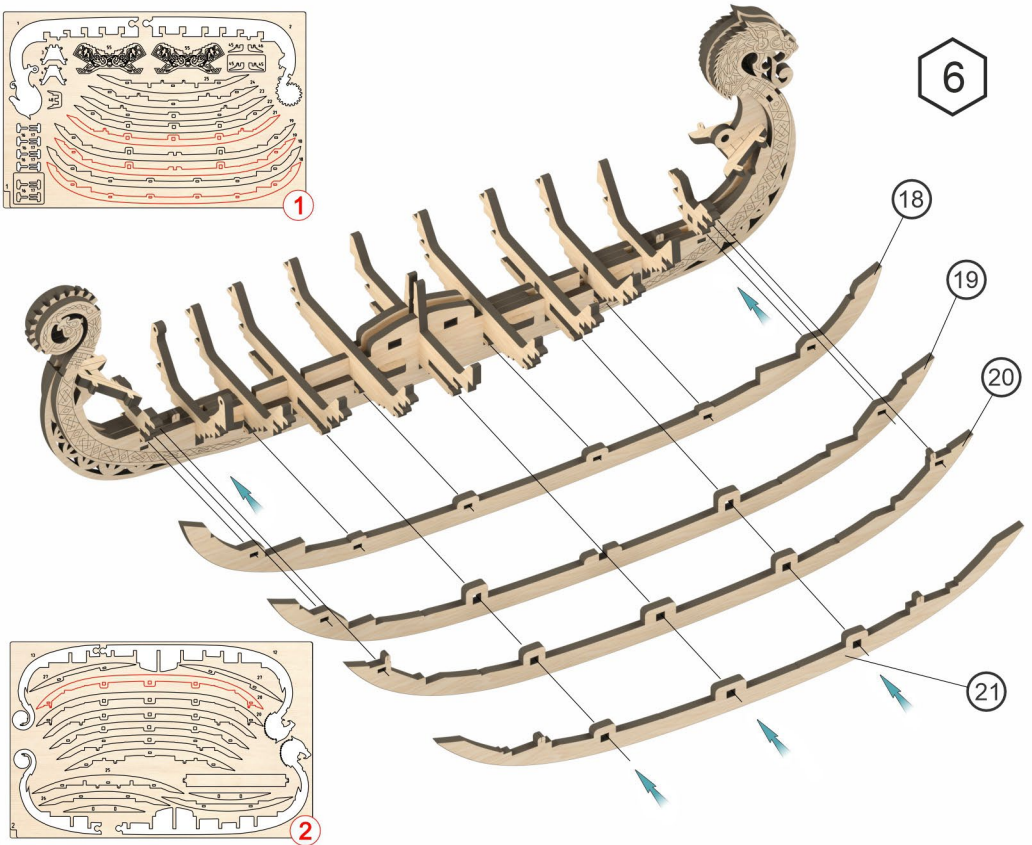

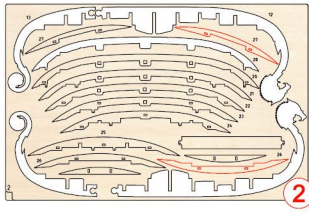
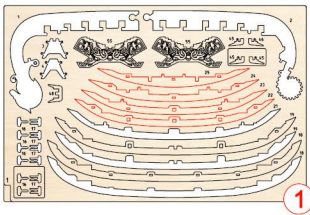

7

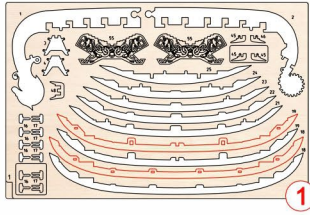
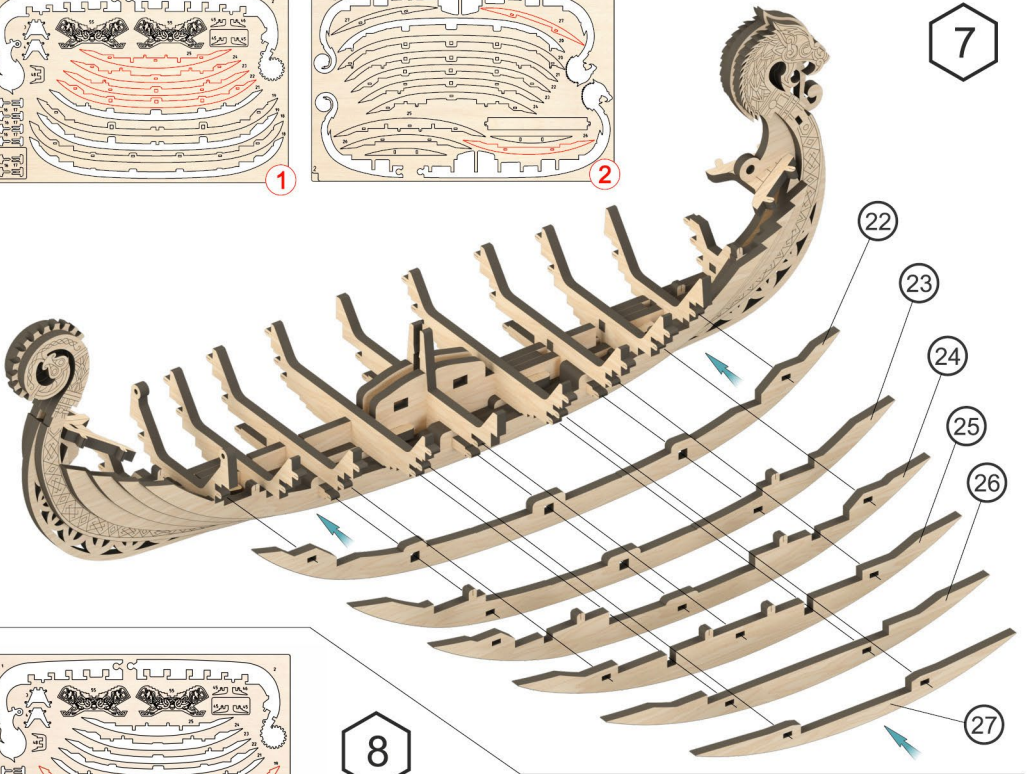

8

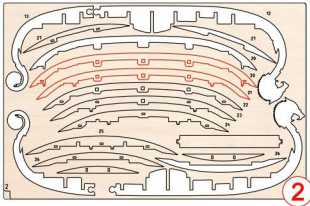
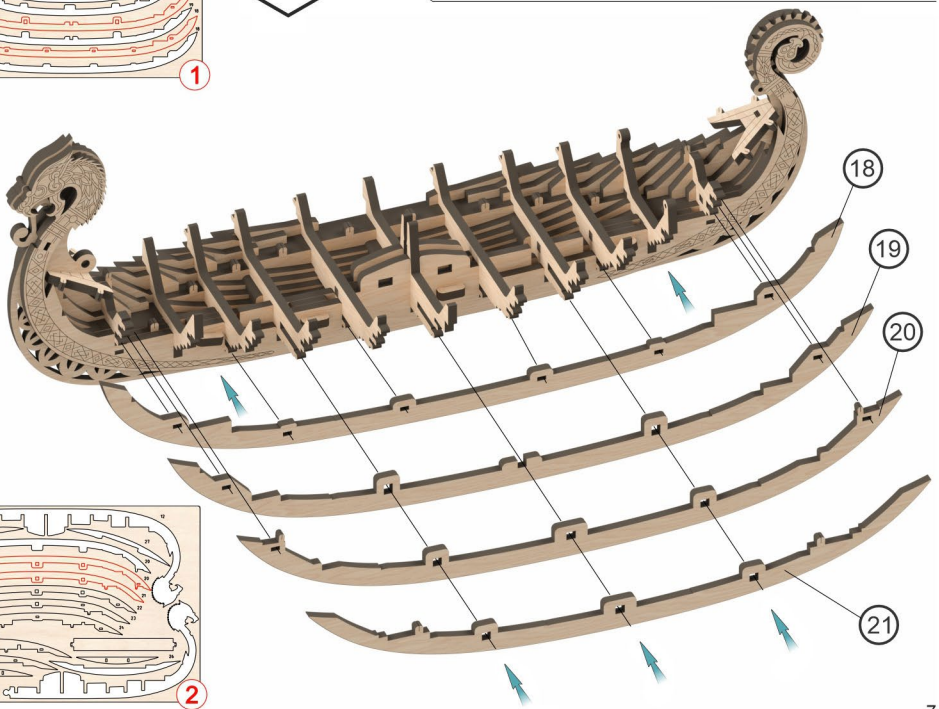

9

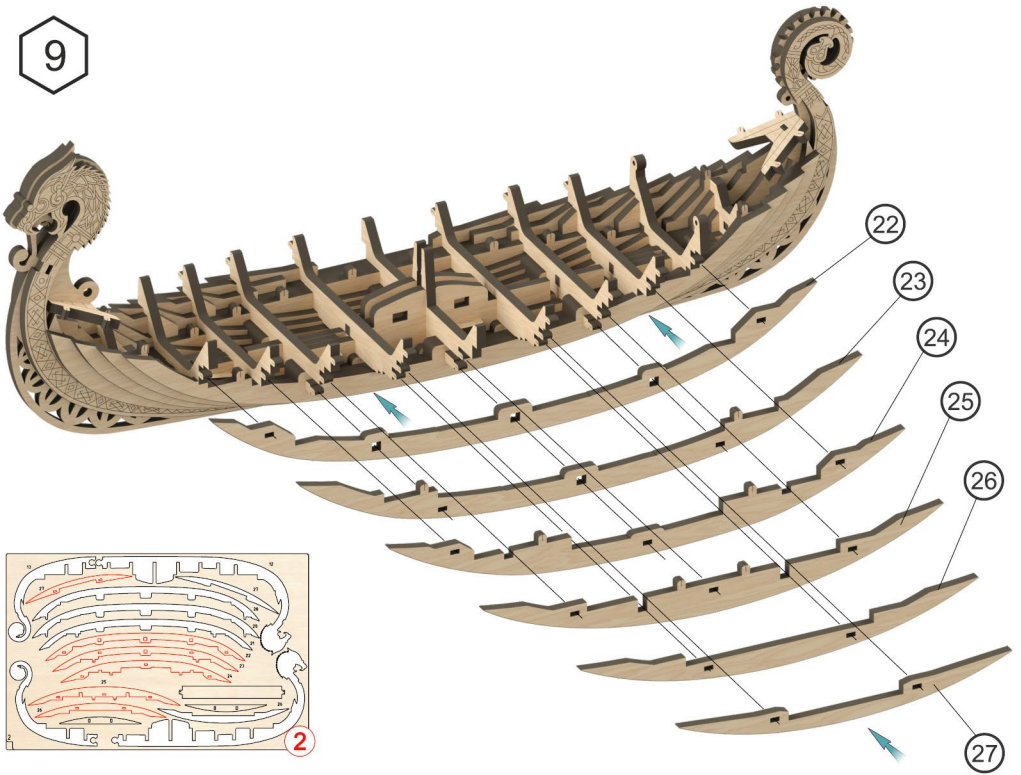

10

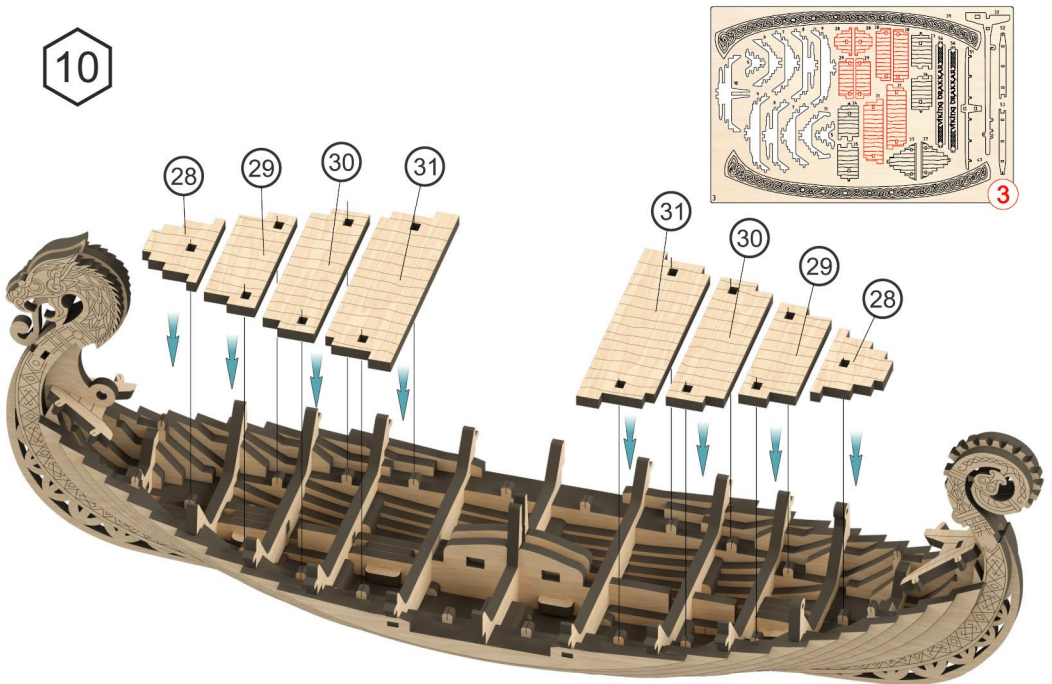

11

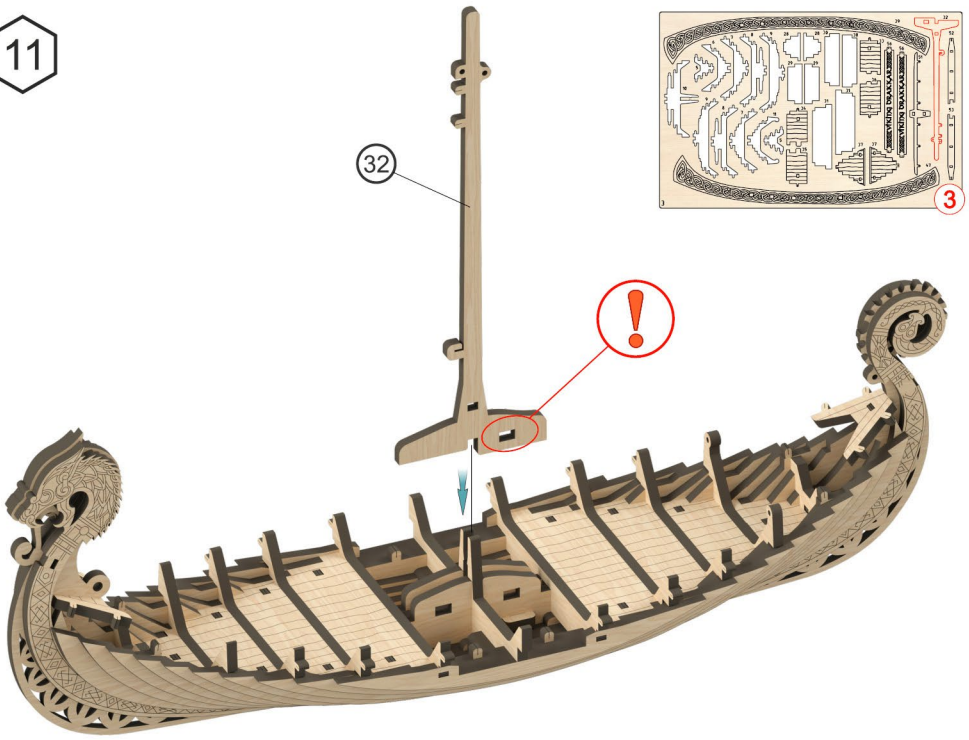

12

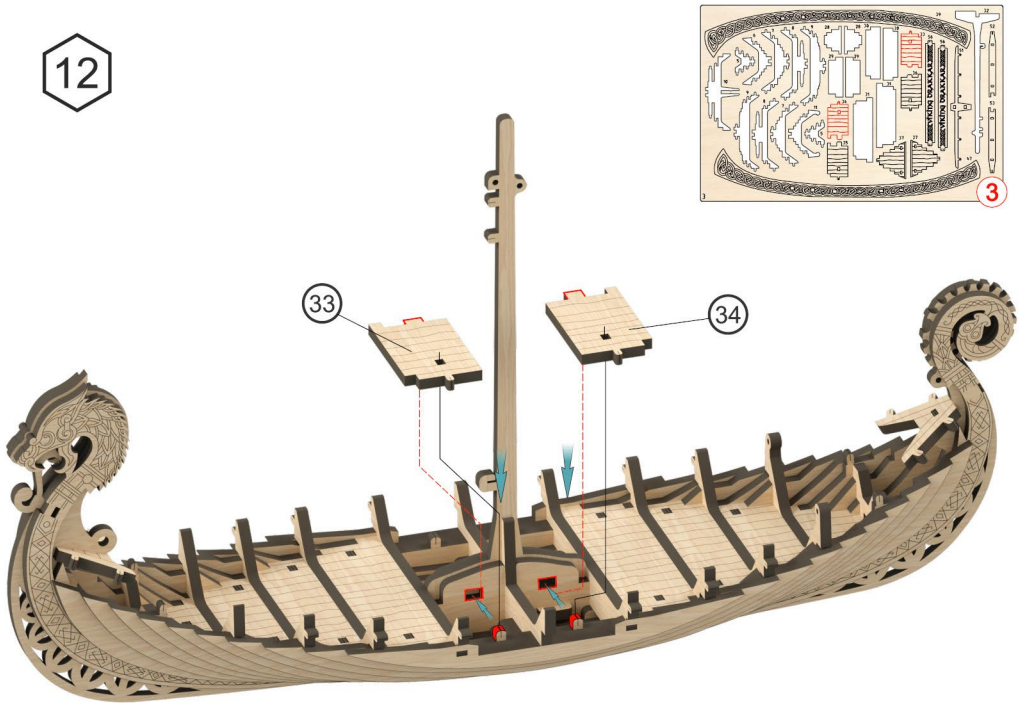

13

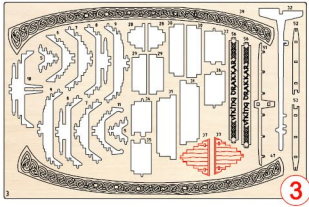
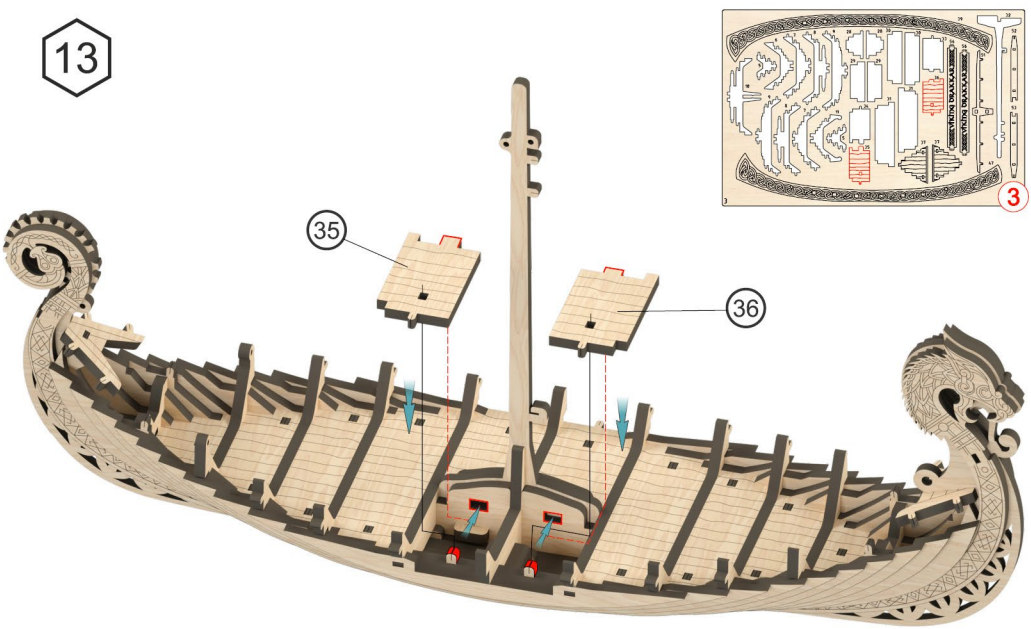

14

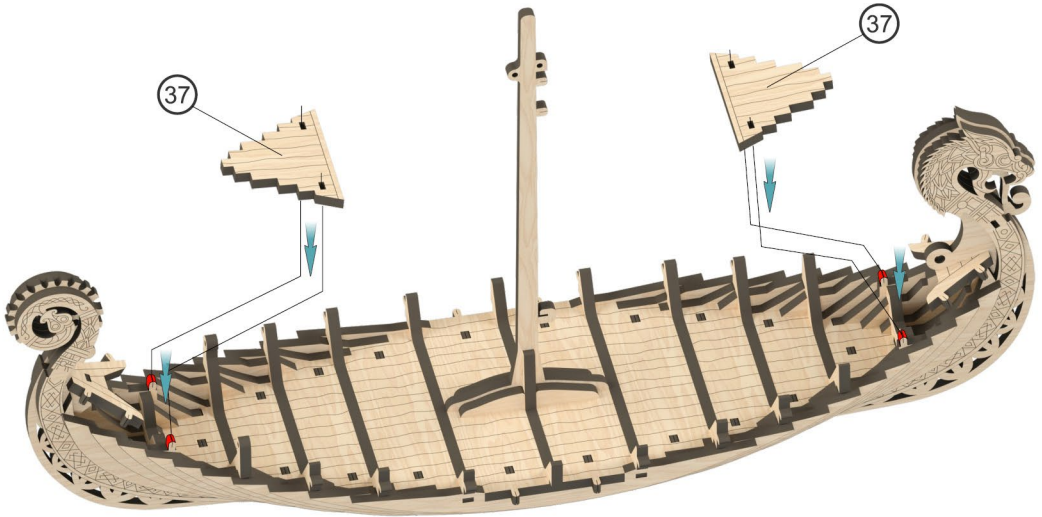

15

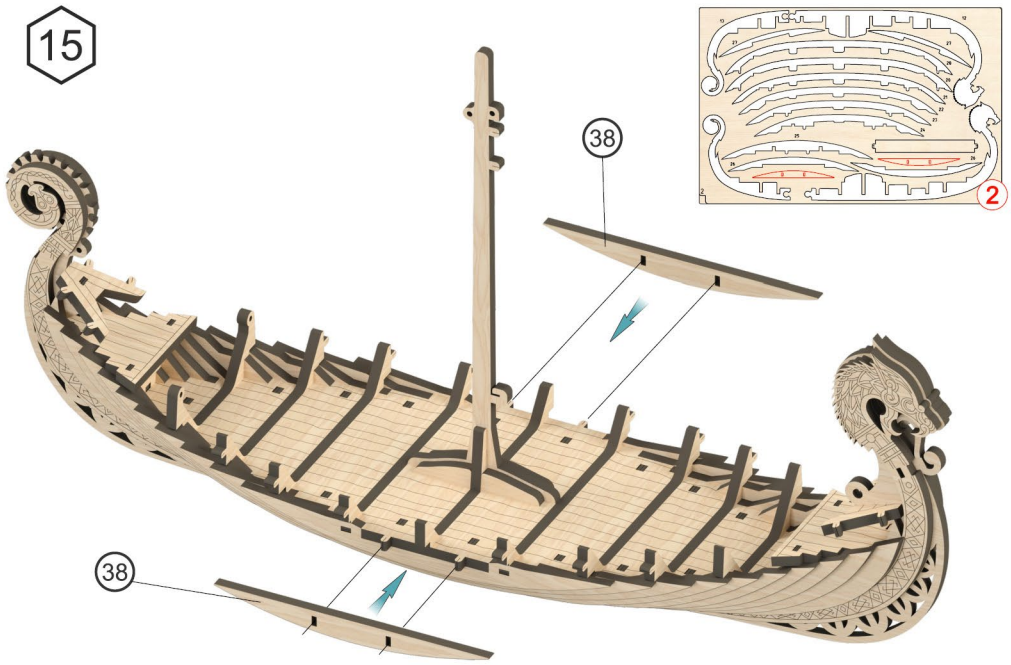

16

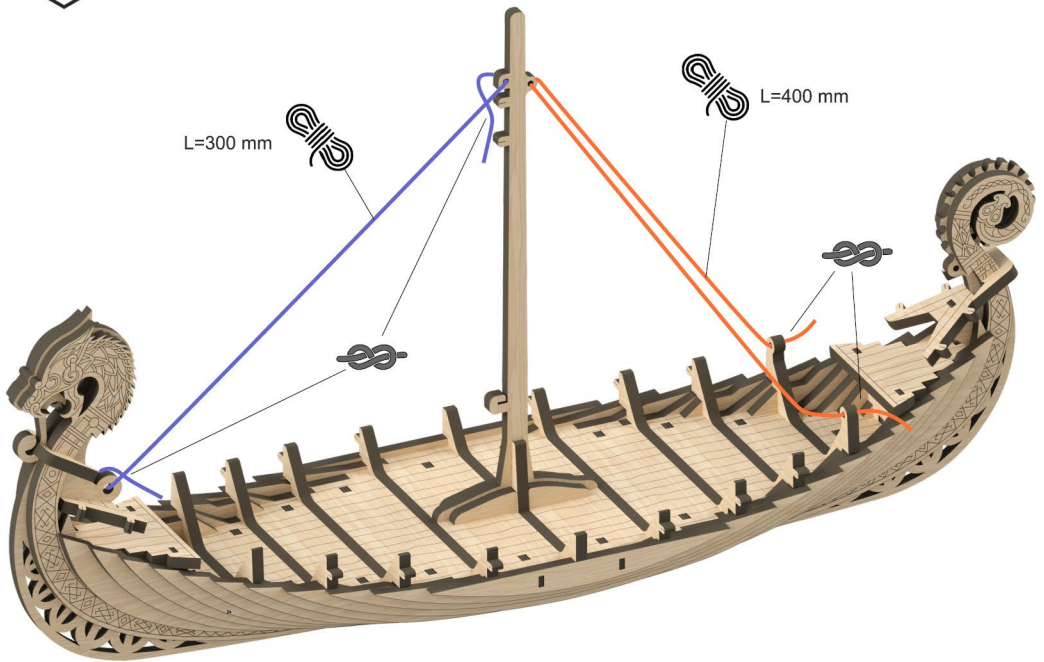

17

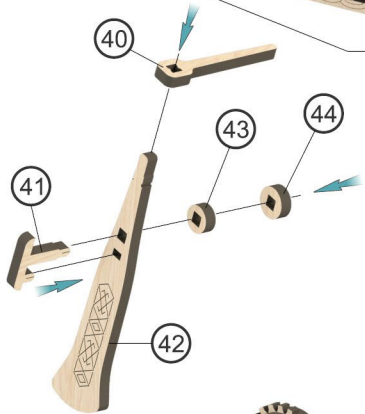
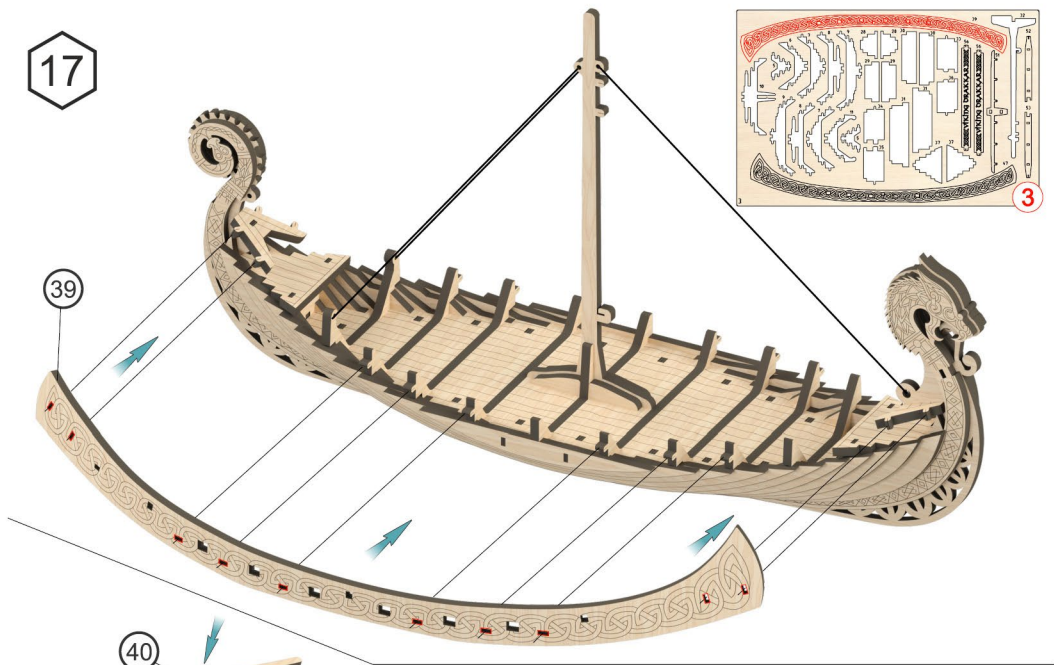

18

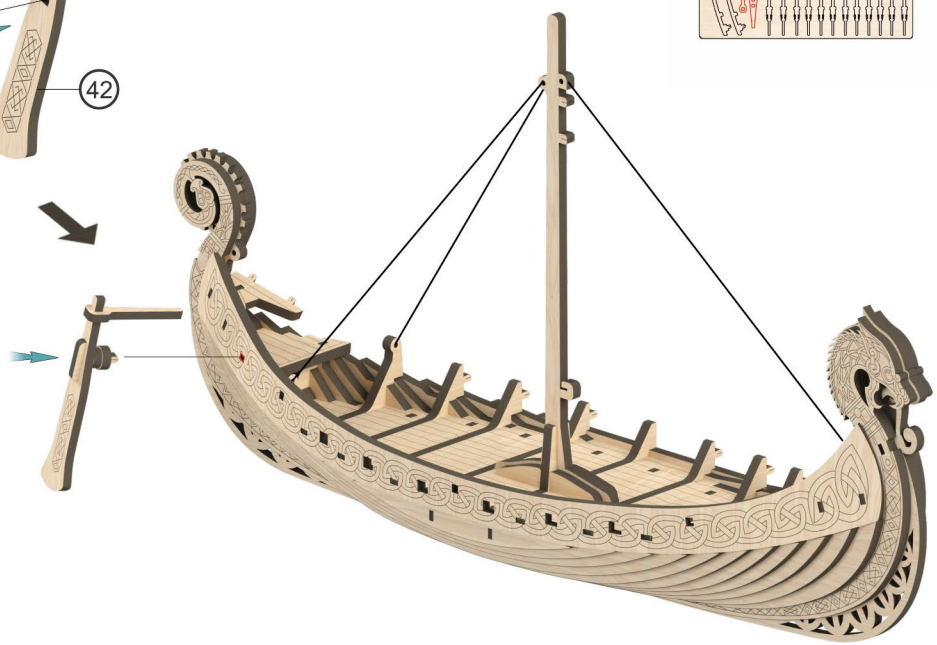

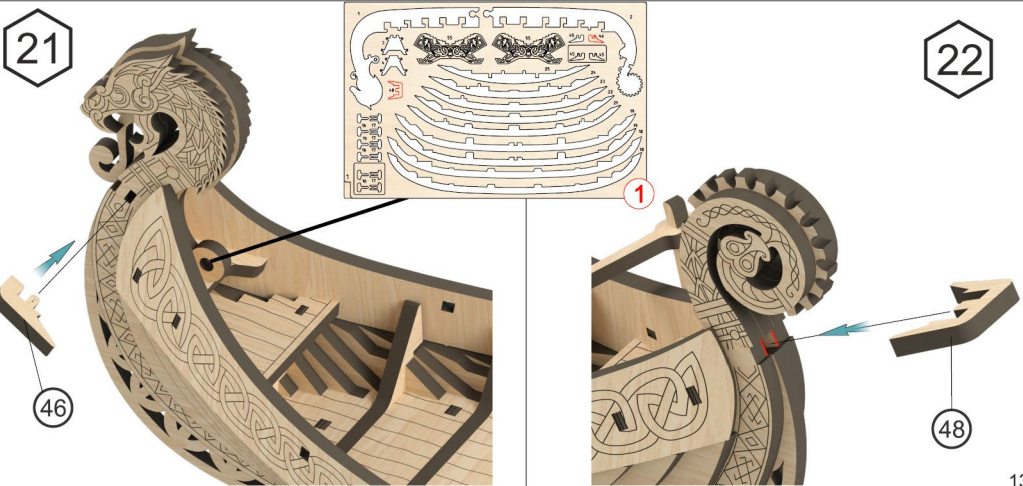
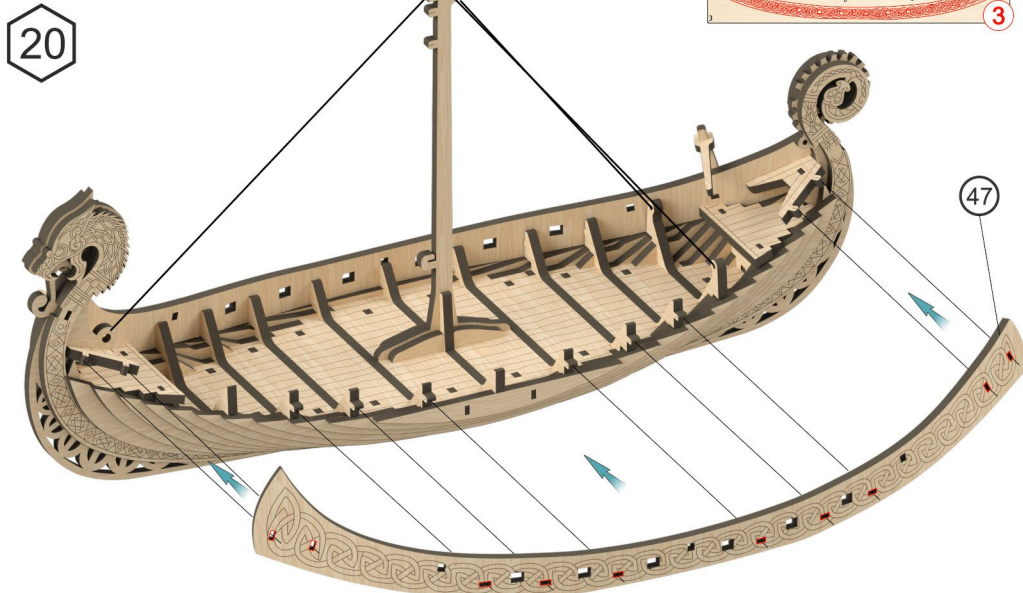
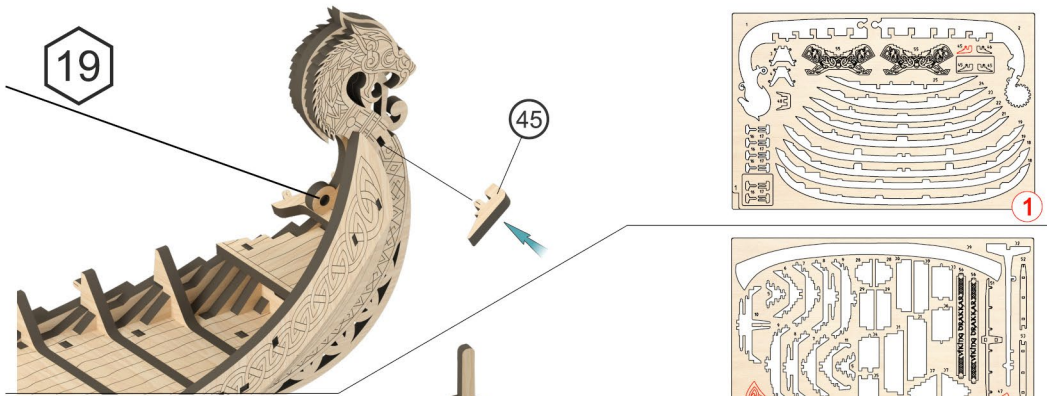

23 x2

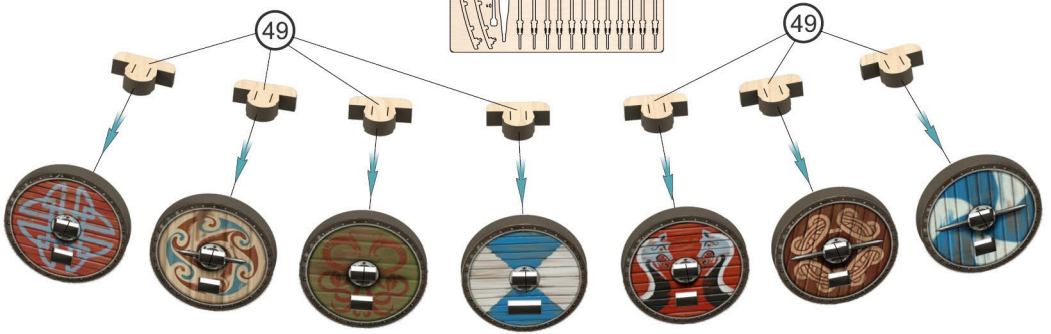
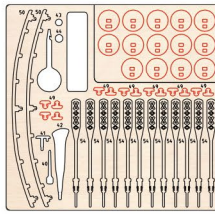

24

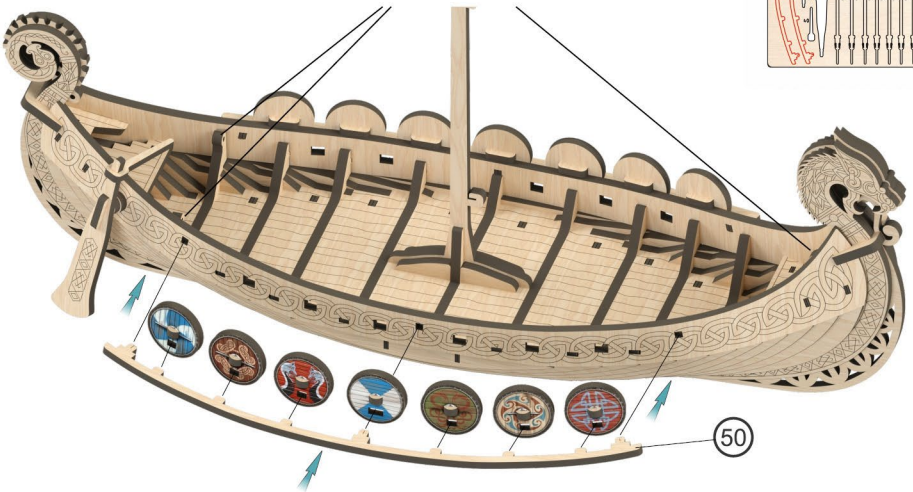
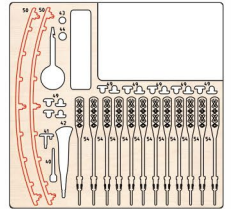
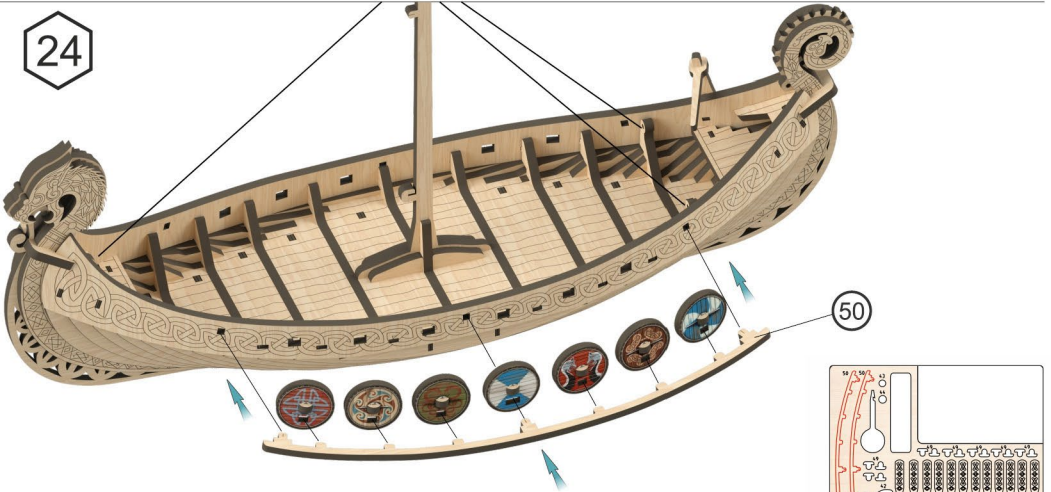

25

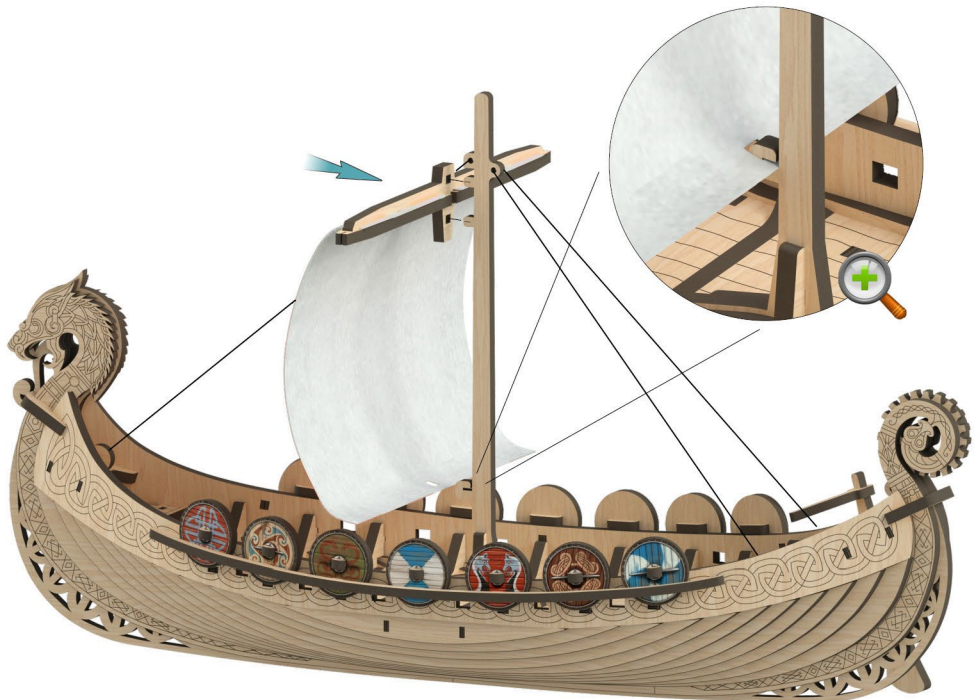
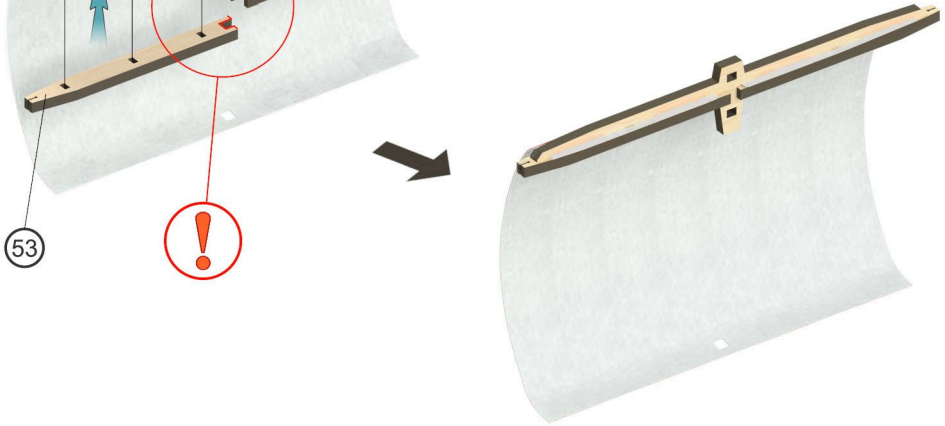
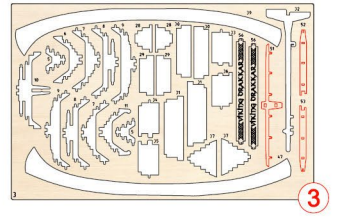
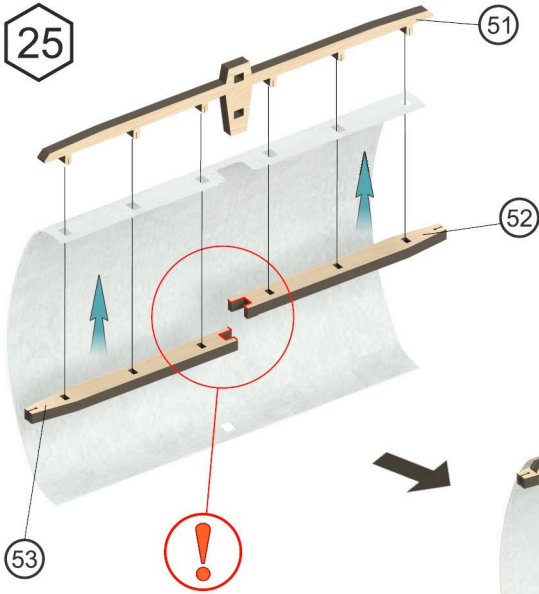

26



27

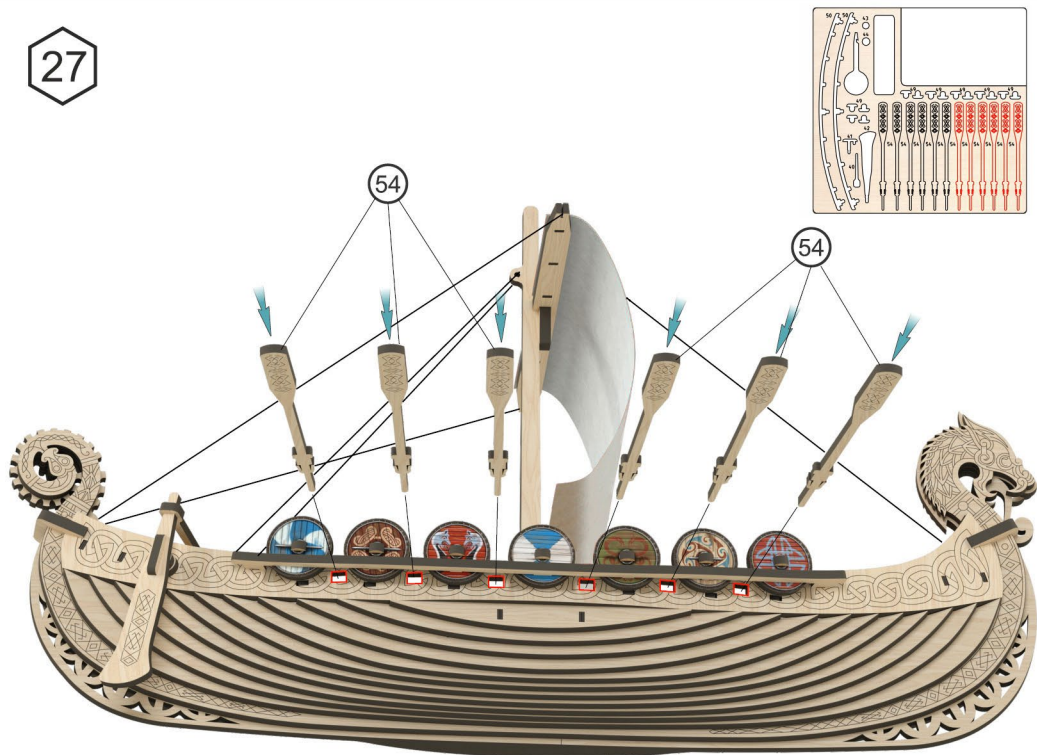

28

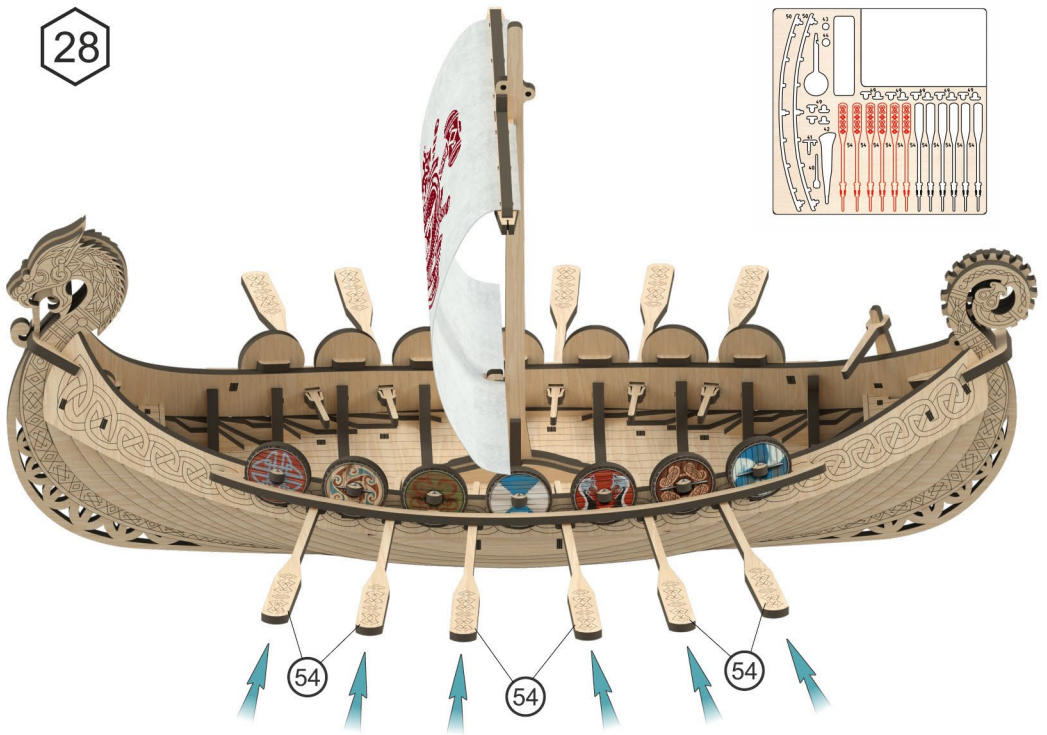

29

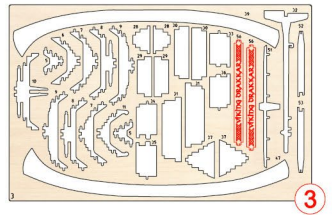
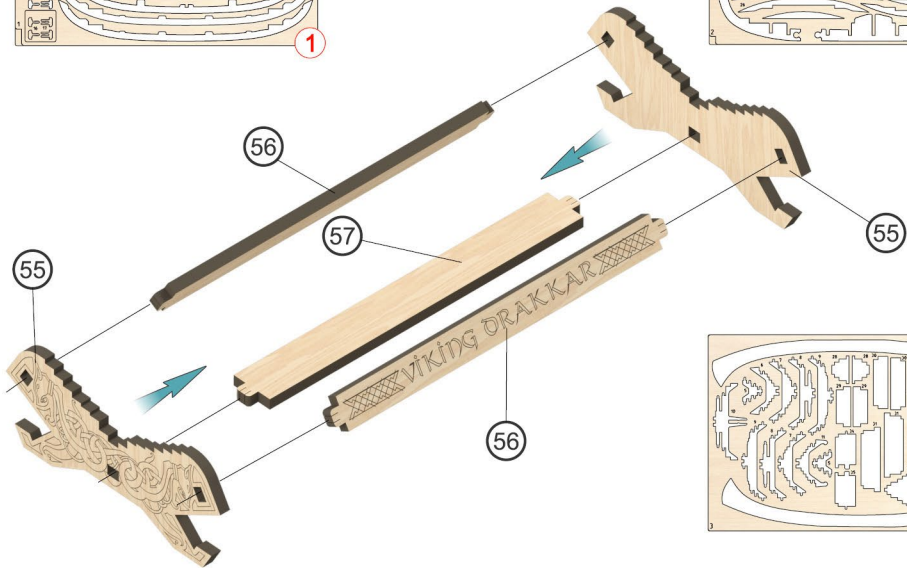
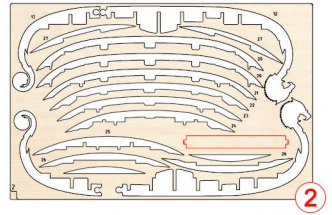
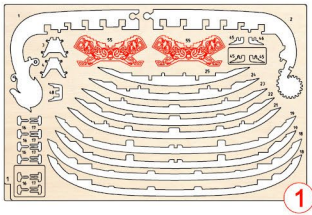

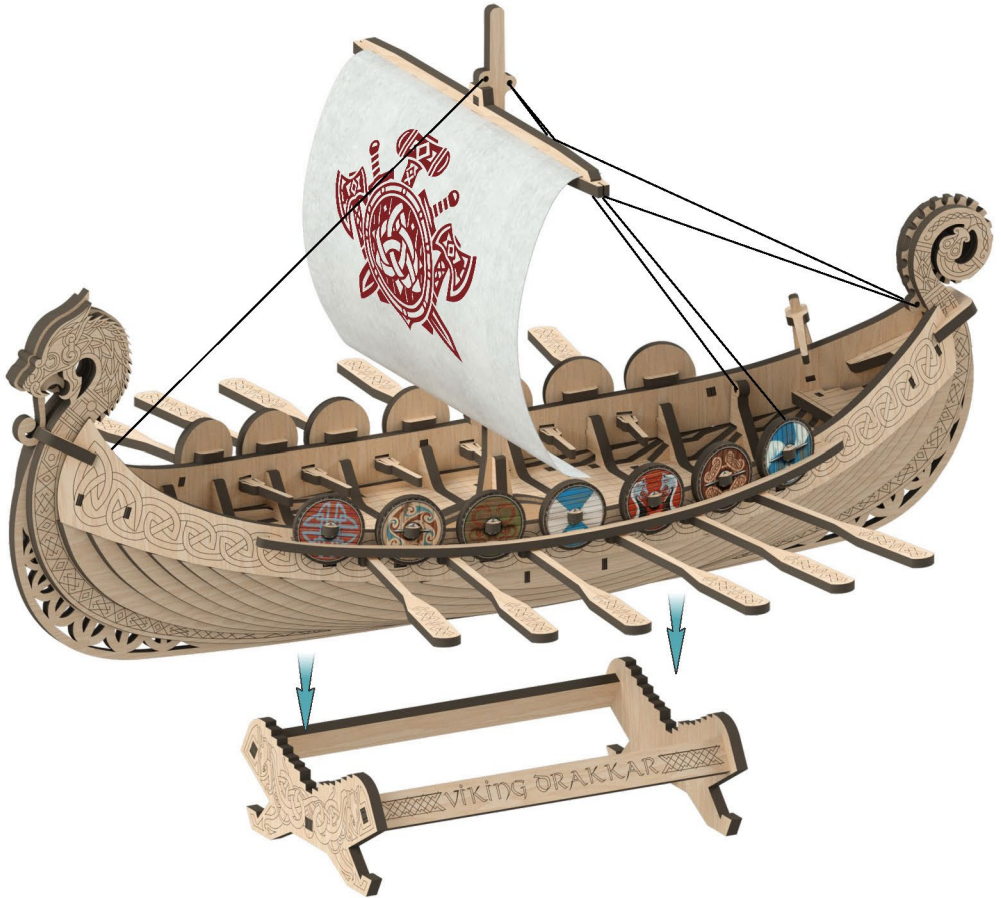

OTHER WOODEN 3D MODELS



CYBER HAND

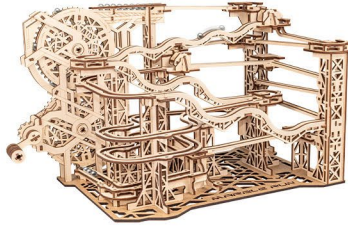

MARBLE RUN



ONE-ARMED BANDIT



PADDLE STEAMER
"RIVER PRINCESS"



LORD OF THE SEAS



AIRPLANE

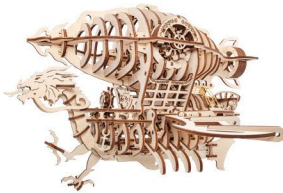

SKYLORD

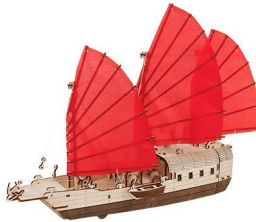

DJONG



GRAMOPHONE

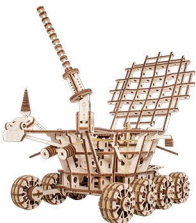

LUNOKHOD



TELEPHONE

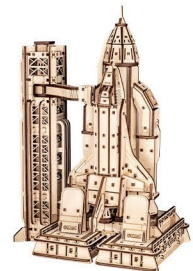

SPACE SHUTTLE

